

WHO operational handbook on tuberculosis

Module 5: Management
of tuberculosis in children
and adolescents



World Health
Organization

WHO operational handbook on tuberculosis

Module 5: Management
of tuberculosis in children
and adolescents

WHO operational handbook on tuberculosis. Module 5: management of tuberculosis in children and adolescents

ISBN 978-92-4-004683-2 (electronic version)

ISBN 978-92-4-004684-9 (print version)

© World Health Organization 2022

Some rights reserved. This work is available under the Creative Commons Attribution-NonCommercial-ShareAlike 3.0 IGO licence (CC BY-NC-SA 3.0 IGO; <https://creativecommons.org/licenses/by-nc-sa/3.0/igo>).

Under the terms of this licence, you may copy, redistribute and adapt the work for non-commercial purposes, provided the work is appropriately cited, as indicated below. In any use of this work, there should be no suggestion that WHO endorses any specific organization, products or services. The use of the WHO logo is not permitted. If you adapt the work, then you must license your work under the same or equivalent Creative Commons licence. If you create a translation of this work, you should add the following disclaimer along with the suggested citation: "This translation was not created by the World Health Organization (WHO). WHO is not responsible for the content or accuracy of this translation. The original English edition shall be the binding and authentic edition".

Any mediation relating to disputes arising under the licence shall be conducted in accordance with the mediation rules of the World Intellectual Property Organization (<http://www.wipo.int/amc/en/mediation/rules/>).

Suggested citation. WHO operational handbook on tuberculosis. Module 5: management of tuberculosis in children and adolescents. Geneva: World Health Organization; 2022. Licence: CC BY-NC-SA 3.0 IGO.

Cataloguing-in-Publication (CIP) data. CIP data are available at <http://apps.who.int/iris>.

Sales, rights and licensing. To purchase WHO publications, see <http://apps.who.int/bookorders>. To submit requests for commercial use and queries on rights and licensing, see <https://www.who.int/copyright>.

Third-party materials. If you wish to reuse material from this work that is attributed to a third party, such as tables, figures or images, it is your responsibility to determine whether permission is needed for that reuse and to obtain permission from the copyright holder. The risk of claims resulting from infringement of any third-party-owned component in the work rests solely with the user.

General disclaimers. The designations employed and the presentation of the material in this publication do not imply the expression of any opinion whatsoever on the part of WHO concerning the legal status of any country, territory, city or area or of its authorities, or concerning the delimitation of its frontiers or boundaries. Dotted and dashed lines on maps represent approximate border lines for which there may not yet be full agreement.

The mention of specific companies or of certain manufacturers' products does not imply that they are endorsed or recommended by WHO in preference to others of a similar nature that are not mentioned. Errors and omissions excepted, the names of proprietary products are distinguished by initial capital letters.

All reasonable precautions have been taken by WHO to verify the information contained in this publication. However, the published material is being distributed without warranty of any kind, either expressed or implied. The responsibility for the interpretation and use of the material lies with the reader. In no event shall WHO be liable for damages arising from its use.

Design by Inis Communication

Contents

Acknowledgements	v
Abbreviations	ix
Definitions	xiii
1. Introduction	1
1.1. Background	1
1.2. Children and adolescents as a key vulnerable population	1
1.3. Rationale and objectives of this operational handbook	2
1.4. Preferences of end-users regarding content and structure of this operational handbook	2
1.5. Structure of the operational handbook	3
1.6. Target audience	4
2. TB screening and contact investigation	5
2.1. Introduction	5
2.2. Contact investigation	6
2.3. TB screening approaches in children and adolescents	17
2.4. Screening children and adolescents living with HIV	24
3. Prevention of TB in children and adolescents	27
3.1. Introduction	27
3.2. BCG vaccination	27
3.3. TB preventive treatment	32
3.4. TB infection prevention and control	50
4. TB diagnostic approaches for children and adolescents	53
4.1. Introduction	53
4.2. Diagnosing TB in children and adolescents	54
4.3. Diagnostic approaches: pulmonary TB	54



4.4. Diagnostic approaches: extrapulmonary TB.....	79
4.5. Disease severity.....	82
4.6. Diagnostic approaches: drug-resistant TB.....	83
5. Treatment of drug-susceptible and drug-resistant pulmonary and extrapulmonary TB in children and adolescents.....	87
5.1. Introduction.....	87
5.2. Treatment of drug-susceptible TB in children and adolescents.....	88
5.3. Treatment of multidrug-resistant and rifampicin-resistant TB in children and adolescents.....	114
5.4. Practical guidance for assessment and management of post-TB health in children and adolescents.....	131
6. Models of TB care for children and adolescents.....	137
6.1. Introduction.....	137
6.2. Decentralized, family-centred, integrated TB services.....	140
6.3. Private-sector involvement in care for children and adolescents with TB.....	154
6.4. Differentiated TB service delivery.....	158
6.5. TB and health emergencies.....	162
7. Special situations.....	165
7.1. Management of TB in children and adolescents living with HIV.....	165
7.2. TB in pregnancy and management of newborns of mothers with TB disease.....	176
7.3. Palliative care for children and adolescents with TB.....	179
7.4. Care for adolescents with or at risk of TB.....	183
7.5. TB in children with severe acute pneumonia.....	188
7.6. Management of children with TB and malnutrition.....	190
8. References.....	197
Annex 1. Selected resources on child and adolescent TB.....	211
Annex 2. Tuberculin skin testing: administration, reading and interpretation.....	214
Annex 3. Sample collection methods.....	217
Annex 4. Standard operating procedures for sample collection methods.....	220
Annex 5. Treatment decision algorithms.....	227
Annex 6. Dosing of medicines used in second-line multidrug-resistant TB regimens by weight band (below 46 kg).....	234
Annex 7. Overview of options for neurocognitive and functional testing at end of treatment for TB meningitis.....	240

Acknowledgements

This operational handbook was prepared by Sabine Verkuijl, Annemieke Brands, Kerri Viney and Tiziana Masini, under the guidance of Farai Mavhunga and the overall direction of Tereza Kasaeva, Director of the World Health Organization (WHO) Global Tuberculosis (TB) Programme.

The WHO Global TB Programme gratefully acknowledges the contributions of all experts who were involved in the production of the operational handbook. Unless otherwise specified, those listed below work in the WHO Global TB Programme.

Chapter 1 (Introduction) was written by Annemieke Brands, with contributions from Sabine Verkuijl, Kerri Viney and Tiziana Masini.

Chapter 2 (Screening and contact investigation) was written by Annemieke Brands and Sabine Verkuijl, with contributions from Saskia Den Boon, Dennis Falzon, Cecily Miller and Kerri Viney. Examples of country experiences with implementation of facility- and community-based approaches for TB contact investigation were provided by the Unitaid-funded Catalyzing Pediatric Tuberculosis Innovation (CaP-TB) project of the Elizabeth Glaser Pediatric AIDS Foundation (EGPAF), Institut de Recherche pour le Développement and Epicentre CONTACT study team.

Chapter 3 (Prevention of TB in children and adolescents) was compiled by Sabine Verkuijl, with contributions from Annemieke Brands, Dennis Falzon, Avinash Kanchar and Kerri Viney.

Chapter 4 (TB diagnostic approaches for children and adolescents) was written by Bryan Vonasek (Baylor College of Medicine, University of Wisconsin, United States of America) and Anna Maria Mandalakas (Baylor College of Medicine, Texas Children's Hospital, United States). The treatment decision algorithms were developed by Kenneth S. Gunasekera (Yale School of Public Health, United States) and James A. Seddon (Imperial College London, United Kingdom of Great Britain and Northern Ireland; and Stellenbosch University, South Africa). Data on nasopharyngeal aspiration were provided by the Unitaid-funded TB-Speed project: Maryline Bonnet (Institut de Recherche pour le Développement, France), Laurence Borand (Pasteur Institute in Cambodia, Cambodia), Chishala Chabala (Lusaka University Teaching Hospital, Zambia), Guillaume Breton (SOLTHIS, France), Celso Khosa (Instituto Nacional de Saúde, Mozambique), Olivier Marcy and Joanna Orne-Gliemann (Université de Bordeaux, France), Raoul Moh (Programme PAC-CI, CHU de Treichville, Côte d'Ivoire), Juliet Mwanga Amumpaire (Mbarara University of Science and Technology, Uganda), Jean-Voisin Taguebue (Chantal Biya Foundation, Cameroon) and Eric Wobudeya (Mulago National Referral Hospital, Uganda; and Makerere University – Johns Hopkins University, Uganda). Sabine Verkuijl, Kerri Viney, Annemieke Brands, Nazir Ismail, Alexei Korobitsyn, Charlie Nathanson and Lice Gonzalez Angulo contributed to the chapter.

Chapter 5 (Treatment of drug-susceptible and drug-resistant pulmonary and extrapulmonary TB in children and adolescents) was written by Alexander W. Kay and Anna Maria Mandalakas (Baylor College of Medicine, United States; sections on drug-susceptible TB); Anthony Garcia-Prats (University of Wisconsin, United States; and Stellenbosch University, South Africa), Anneke C. Hesseling and H. Simon Schaaf (Stellenbosch University, South Africa), James A. Seddon (Imperial College London, United Kingdom; and Stellenbosch University, South Africa; section on drug-resistant TB treatment); and Marieke M. van der Zalm, H. Simon Schaaf, Ronald van Toorn, Regan Solomons, Pierre Goussard, Mari Thiart, Karen Du Preez, Michale G. Anthony, Graeme Hoddinott and Anneke C. Hesseling

(Stellenbosch University, South Africa; section on post-TB health), with contributions from Sabine Verkuijl, Kerri Viney, Annemieke Brands, Tiziana Masini, Fuad Mirzayev, Medea Gegia, Linh Nhat Nguyen and Samuel Schumacher.

Chapter 6 (Models of TB care for children and adolescents) was written by Moorine Sekkade (National TB and Leprosy Programme, Uganda), with contributions from Sabine Verkuijl, Annemieke Brands, Kerri Viney, Liana Oganezova, Dennis Falzon, Monica Diaz and Ernesto Jaramillo. Examples of country experiences with decentralized, family-centred, integrated approaches to child and adolescent TB services were provided by the Unitaid-funded CaP-TB project (EGPAF CaP-TB Headquarters and Country teams, EGPAF INPUT study team) and the Unitaid-funded TB-Speed project: Maryline Bonnet (Institut de Recherche pour le Développement, France), Laurence Borand (Pasteur Institute in Cambodia, Cambodia), Guillaume Breton (SOLTHIS, France), Celso Khosa (Instituto Nacional de Saúde, Mozambique), Olivier Marcy and Joanna Orne-Gliemann (Université de Bordeaux, France), Raoul Moh (Programme PAC-CI, CHU de Treichville, Côte d'Ivoire), Juliet Mwanga Amumpaire (Mbarara University of Science and technology, Uganda), Jean-Voisin Taguebue (Chantal Biya Foundation, Cameroon) and Eric Wobudeya (Mulago National Referral Hospital, Uganda; and Makerere University – Johns Hopkins University, Uganda). Cuc Tran and Brittany K. Moore (Centres for Disease Control and Prevention, United States) provided the examples on differentiated service delivery.

Chapter 7 (Special situations) was developed by Sabine Verkuijl, with contributions from Martina Penazzato and Ivy Kasiriye (WHO Global HIV, Hepatitis and Sexually Transmitted Infections Programme), Wilson Milton Were (WHO Department of Maternal, Newborn, Child and Adolescent Health and Ageing), Marie-Charlotte Bouësseau, Elizabeth Gwyther and Anna Marie Ray (WHO Department of Integrated Health Services), Julia Downing (International Children Palliative Care Network, United Kingdom), Ernesto Jaramillo, Annemieke Brands and Kerri Viney. A review on the impact of TB on adolescent well-being, challenges to care provision, and recommendations for care optimization was conducted by Silvia S. Chiang (Alpert Medical School of Brown University and Rhode Island Hospital, United States), Patricia Moscibrodzki (London School of Hygiene and Tropical Medicine, United Kingdom), Leslie A. Enane (Indiana University School of Medicine, United States), with contributions from Margaux Amara, Meredith B. Brooks, Virginia Byron, Jennifer Furin (Harvard Medical School, United States), Sarah Bernays (University of Sydney, Australia; and London School of Hygiene and Tropical Medicine, United Kingdom), Yaroslava Bondarenko (Bogomolets National Medical University, Ukraine), Márcia Cortez Bellotti de Oliveria (Universidade Federal do Rio de Janeiro, Brazil), Andrea T. Cruz (Baylor College of Medicine, United States), Hernán Del Castillo Barrientos (Instituto Nacional de Salud del Niño-Breña, Peru), Anthony Enimil (Kwame Nkrumah University of Science and Technology, Ghana; and Komfo Anokye Teaching Hospital, Ghana), Vivian Faith (Network of TB Champions in Kenya, Kenya), Gabriella Ferlazzo (Médecins Sans Frontières, South Africa), Rashida Abbas Ferrand (Rhode Island Hospital, United States; and Biomedical Research and Training Institute, Zimbabwe), Graeme Hoddinott (Stellenbosch University, South Africa), Petros Isaakidis (Médecins Sans Frontières, South Africa), Evgenia Karayeva (Brown School of Public Health, United States), Katharina Kranzer (Rhode Island Hospital, United States; and Biomedical Research and Training Institute, Zimbabwe), Homa Mansoor (Médecins Sans Frontières, India), Ben J. Marais (Marie Bashir Institute for Infectious Diseases; and University of Sydney, Australia), Lily Meyersohn (Rhode Island Hospital, United States), Victoria Oliva Rapoport (Alpert Medical School of Brown University, United States), Erika Mohr-Holland (Médecins Sans Frontières, South Africa), Anh Phuong Nguyen (TB Patients Community of Vietnam, Hanoi, Viet Nam), Joshua Ochieng Oliyo (Committee of African Youth Advisors, Kenya), Clemax Couto Sant'Anna (Universidade Federal do Rio de Janeiro, Brazil), Saning'o Saruni (Haydom Lutheran Hospital, United Republic of Tanzania), Susan M. Sawyer (Royal Children's Hospital, Murdoch Children's Research Institute, and University of Melbourne, Australia), H. Simon Schaaf (Stellenbosch University, South Africa), James A. Seddon (Imperial College London, United Kingdom; and Stellenbosch University, South Africa), Sangeeta Sharma (National Institute of Tuberculosis and Respiratory Diseases, India), Alena Skrahina (Republican Research and Practical Centre for Pulmonology and TB, Belarus), Jeffrey R. Starke (Baylor College of Medicine, United States), Tania A. Thomas (University of Virginia, United States), Rina Triasih (Universitas Gadjah Mada and Dr Sardjito Hospital, Indonesia), Bazarragchaa

Tsogt (Mongolian Tuberculosis Coalition, Mongolia), Henry Welch (Baylor College of Medicine, United States; and University of Papua New Guinea, Papua New Guinea) and Olga Zvonareva (Maastricht University, Netherlands). Findings from the Unitaid-funded TB-Speed pneumonia study were provided by Maryline Bonnet (Institut de Recherche pour le Développement, France), Laurence Borand (Pasteur Institute, Cambodia), Chishala Chabala (University of Zambia, Zambia), Celso Khosa (Instituto Nacional de Saúde, Mozambique), Olivier Marcy (Université de Bordeaux, France), Raoul Moh (Programme PAC-CI, CHU de Treichville, Côte d'Ivoire), Juliet Mwanga Amumpaire (Mbarara University of Science and Technology, Uganda), Jean-Voisin Taguebue (Chantal Biya Foundation, Cameroon) and Eric Wobudeya (Mulago National Referral Hospital, Uganda; and Makerere University – Johns Hopkins University, Uganda).

The WHO Global TB Programme also acknowledges Ben Marais (University of Sydney, Australia) for background work on the classification of intrathoracic TB disease in children; Elin Svensson (Radboud University Medical Center, Netherlands; and Uppsala University, Sweden) for background work on dosing of bedaquiline and delamanid; and Kelly Dooley (Johns Hopkins University, United States), Paolo Denti and Roeland Wasmann (University of Cape Town, South Africa) for background work on dosing of the short intensive TB meningitis regimen. Paolo Denti and Roeland Wasmann are also acknowledged for their work on the updated table on dosing of medicines used in second-line multidrug-resistant TB regimens in annex 6.

The external review group was composed of Jeffrey P. Acaba (APCASO, Thailand), Farhana Amanullah (Indus Hospital, Pakistan), Martina Casenghi (Elizabeth Glaser Pediatric AIDS Foundation, Switzerland), Charlotte Colvin (United States Agency for International Development, United States), Fernanda Dockhorn Costa (Ministry of Health, Brazil), Anne Detjen (United Nations Children's Fund, United States), Jennifer Furin (Harvard Medical School, United States), Christopher Gilpin (International Organization for Migration, Switzerland), Stephen Graham (University of Melbourne, Australia), Anneke C. Hesselting (Stellenbosch University, South Africa), Evaline Kibuchi (Kenya AIDS NGOs Consortium, Kenya), Blessi Kumar (Global Coalition of TB Activists, India), Ben Marais (University of Sydney, Australia), Olivier Marcy (Université de Bordeaux, France), Lindsay McKenna (Treatment Action Group, United States), Lisa Obimbo (Nairobi University, Kenya), Anna Scardigli (Global Fund to Fight AIDS, Tuberculosis and Malaria, Switzerland), James A. Seddon (Imperial College London, United Kingdom; and Stellenbosch University, South Africa), Moorine Sekadde (National TB and Leprosy Programme, Uganda), Alena Skrahina (National TB Programme, Belarus) and Rina Triasih (Sardjito Hospital, Indonesia).

The writing, design and layout of this operational handbook were made possible by funding provided by Unitaid, the United States Agency for International Development and the United States Centers for Disease Control and Prevention.

Abbreviations

ABC	abacavir
AIDS	acquired immunodeficiency syndrome
ALT	alanine aminotransferase
Am	amikacin
amoxiclav	amoxicillin with clavulanic acid (also known as co-amoxiclav)
aOR	adjusted odds ratio
ART	antiretroviral therapy
AST	aspartate aminotransferase
AZT	zidovudine
B (or Bdq)	bedaquiline
BCG	bacille Calmette-Guérin
CaP-TB	Catalyzing Pediatric Tuberculosis Innovation
Cfz	clofazimine
CHW	community health worker
CI	confidence interval
CNS	central nervous system
CONTACT	Community Intervention for Tuberculosis Active Contact Tracing and Preventive Therapy
COVID-19	coronavirus disease 2019
CPT	co-trimoxazole preventive therapy
CRP	C-reactive protein
Cs	cycloserine
CSF	cerebrospinal fluid
CT	computed tomography
CXR	chest X-ray
Dlm	delamanid
DR-TB	drug-resistant tuberculosis
DSD	differentiated service delivery
DST	drug susceptibility testing
DTG	dolutegravir
E	ethambutol
ECG	electrocardiogram
EFV	efavirenz
EPTB	extrapulmonary tuberculosis
ETAT	emergency triage, assessment and treatment

Eto	ethionamide
FDC	fixed-dose combination
FTC	emtricitabine
GDF	Stop TB Partnership Global Drug Facility
H	isoniazid
HCW	health care worker
HIV	human immunodeficiency virus
iCCM	integrated community case management
IGRA	interferon-gamma release assay
IMCI	integrated management of childhood illness
IMNCI	integrated management of newborn and childhood illness
IPT	isoniazid preventive therapy
IRIS	immune reconstitution inflammatory syndrome
L (or Lzd)	linezolid
LF-LAM	lateral flow lipoarabinomannan assay
Lfx	levofloxacin
LPA	line probe assay
LPV/r	lopinavir/ritonavir
M (or Mfx)	moxifloxacin
MAF-TB	multisectoral accountability framework to end tuberculosis
MDR-TB	multidrug-resistant tuberculosis
Mpm	meropenem
mWRD	molecular WHO-recommended rapid diagnostic test
NAAT	nucleic acid amplification test
NPA	nasopharyngeal aspiration
NRTI	nucleoside reverse-transcriptase inhibitor
NTP	national tuberculosis programme
NVP	nevirapine
P	rifapentine
Pa	pretomanid
PAS	p-aminosalicylic acid
PCR	polymerase chain reaction
PHC	primary health care
PI	protease inhibitor
PI/r	protease inhibitor boosted with ritonavir
PPD	purified protein derivative
PTB	pulmonary tuberculosis
Pto	prothionamide
PZA (or Z)	pyrazinamide
R	rifampicin

RAL	raltegravir
RR-TB	rifampicin-resistant tuberculosis
RTV (or r)	ritonavir
S	streptomycin
SAM	severe acute malnutrition
SDGs	Sustainable Development Goals
SOS	Simple One-step (stool processing method)
TAF	tenofovir alafenamide
TB	tuberculosis
TBM	tuberculosis meningitis
TDF	tenofovir disoproxil fumarate
TPT	tuberculosis preventive treatment
Trd	terizidone
TST	tuberculin skin test
TU	tuberculin unit
W4SS	WHO-recommended four-symptom screen
WFA	weight-for-age
WHO	World Health Organization
XDR-TB	extensively drug-resistant tuberculosis
Z (or PZA)	pyrazinamide

Definitions

Unless otherwise specified, the terms defined here apply as used in this operational handbook. They may have different meanings in other contexts.

Active (tuberculosis) case-finding: Provider-initiated screening and testing in communities by mobile teams, often using mobile X-ray and rapid molecular tests. The term is sometimes used synonymously with “systematic screening”.

Adherence: Extent to which a person’s behaviour (e.g. taking medicines, following a particular diet, changing lifestyle) corresponds with agreed recommendations from a health care provider.

Advanced HIV disease: For adolescents and children aged 5 years and over, this is defined as a CD4 cell count below 200 cells/mm³ or a WHO clinical stage 3 or 4 event at presentation for care. All children aged under 5 years living with HIV should be considered as having advanced disease at presentation.

Adverse event: Any untoward medical occurrence that may present in a person with TB during treatment with a pharmaceutical product but that does not necessarily have a causal relationship with the treatment.

Age groups: Unless stated otherwise in the text, the following definitions apply to the terms used in this handbook:

- Infant: aged under 1 year (12 months).
 - Child: aged under 10 years.
 - Young child: aged under 5 years.
- Adolescent: aged 10–19 years (inclusive).
 - Young adolescent: aged 10–14 years.
 - Older adolescent: aged 15–19 years.
- Adult: aged 20 years or over.

Background HIV and tuberculosis drug resistance prevalence: Settings with high HIV prevalence are defined as those in which the HIV prevalence is 1% or higher among adult pregnant women, or 5% or higher among people with TB. WHO does not intend to establish thresholds for low, moderate or high levels of prevalence of isoniazid resistance. National TB programmes will establish definitions for their own countries.

Bacteriologically confirmed tuberculosis: TB diagnosed in a biological specimen by a WHO-approved rapid test such as Xpert[®] MTB/RIF or LF-LAM, smear microscopy or culture.

Contact: Any person exposed to a person with TB.

Contact investigation: Systematic identification of people, including children and adolescents, with previously undiagnosed TB disease and TB infection among the contacts of an index TB patient in the household and in comparable settings in which transmission occurs. It consists of identification, clinical evaluation and/or testing and provision of appropriate TB treatment (for people with confirmed TB) or TB preventive treatment (for people without TB disease).

Decentralization: Depending on the standard in the research settings used for the comparator, this includes provision of, access to or capacity for child and adolescent TB services at a lower level of the health system than the lowest level where this is currently routinely provided. In most settings, decentralization applies to the district hospital (first referral level hospital) level and/or primary health care level and/or community level. Interventions for decentralization include capacity-building of various cadres of health care workers, expanding access to diagnostic services, ensuring availability of TB medicines for children and adolescents, and follow-up of children and adolescents with TB or on TB preventive treatment.

Differentiated HIV service delivery model: Person-centred approach to simplify provision of HIV services across the cascade in ways that better serve the needs of people living with HIV and reduce unnecessary burdens on the health system.

Drug susceptibility testing (DST): In vitro testing using either molecular genotypic techniques to detect resistance-conferring mutations, or phenotypic methods to determine susceptibility to a medicine.¹

Extensive (or advanced) pulmonary tuberculosis disease: Presence of bilateral cavitory disease or extensive parenchymal damage on chest radiography (CXR). In children aged under 15 years, advanced disease is usually defined by the presence of cavities or bilateral disease on CXR.

Extensively drug-resistant tuberculosis (XDR-TB):²

- Pre-XDR-TB: TB caused by *Mycobacterium tuberculosis* strains that fulfil the definition of multidrug-resistant TB (MDR-TB) or rifampicin-resistant TB (RR-TB) and that are also resistant to any fluoroquinolone.³
- XDR-TB: TB caused by *M. tuberculosis* strains that fulfil the definition of MDR/RR-TB and that are also resistant to any fluoroquinolone and at least one additional Group A medicine.⁴

Extrapulmonary tuberculosis (EPTB) (classification): Any bacteriologically confirmed or clinically diagnosed case of TB involving organs other than the lungs (e.g. pleura, peripheral lymph nodes, abdomen, genitourinary tract, skin, joints and bones, meninges).⁵

Family-centred, integrated care: Family-centred models of care refer to interventions selected on the basis of the needs, values and preferences of the child or adolescent and their family or caregiver. This can include health education, communication, material or psychological support. Integrated services refer to approaches to strengthen collaboration, coordination, integration and harmonization of child and adolescent TB services with other child health-related programmes and services. This can include integration of models of care for TB screening, prevention, diagnosis and treatment with other existing service delivery platforms for maternal and child health (e.g. antenatal care, integrated community case management, integrated management of childhood illnesses) and other related services (e.g. HIV, nutrition, immunization). Other examples include evaluation of children and adolescents with common comorbidities (e.g. meningitis, malnutrition, pneumonia, chronic lung disease, diabetes, HIV) for TB and community health strategies integrating child and adolescent TB awareness, education, screening, prevention and case-finding into training and service delivery activities.

¹ Implementing tuberculosis diagnostics: a policy framework. Geneva: World Health Organization; 2015 (<https://apps.who.int/iris/handle/10665/162712>, accessed 11 March 2022).

² Meeting report of the WHO expert consultation on the definition of extensively drug-resistant tuberculosis, 27–29 October 2020. Geneva: World Health Organization; 2021 (<https://www.who.int/publications/i/item/meeting-report-of-the-who-expert-consultation-on-the-definition-of-extensively-drug-resistant-tuberculosis>, accessed 11 March 2022).

³ The fluoroquinolones include levofloxacin and moxifloxacin as currently recommended by WHO for inclusion in shorter and longer regimens.

⁴ Group A medicines are currently levofloxacin or moxifloxacin, bedaquiline and linezolid; therefore, XDR-TB is MDR/RR-TB that is resistant to a fluoroquinolone and either bedaquiline or linezolid (or both). Group A medicines could change in the future. Therefore, the terminology “Group A” is appropriate here and will apply to any Group A medicines in the future.

⁵ Following a WHO expert consultation in September 2021, intrathoracic lymph node TB is now classified as pulmonary TB in children.

Grading of Recommendations Assessment, Development and Evaluation (GRADE): System for rating quality of evidence and strength of recommendations. This approach is explicit, comprehensive, transparent and pragmatic.⁶

High tuberculosis transmission setting: Setting with a high frequency of people with undetected or undiagnosed TB disease, or where people with infectious TB are present and there is a high risk of TB transmission. People with TB are most infectious when they are untreated or inadequately treated. Spread is increased by aerosol-generating procedures and by the presence of highly susceptible people.

Household contact: Person who shared the same enclosed living space as the index case for one or more nights or for frequent or extended daytime periods during the 3 months before the start of current treatment.

Index case (index patient) of tuberculosis: Initially identified person of any age with new or recurrent TB in a specific household or other comparable setting in which others may have been exposed. An index case is the person on which a contact investigation is centred but is not necessarily the source case.

Inpatient health care setting: Health care facility where people are admitted and assigned a bed while undergoing diagnosis and receiving treatment and care, for at least one overnight stay.

Integrated treatment decision algorithm: Flowchart allocating evidence-based scores to microbiological, clinical and radiological features that allow clinicians to make decisions regarding starting TB treatment in children.

Interferon-gamma release assay (IGRA): Blood test used to test for *Mycobacterium tuberculosis* infection by measuring the body's immune response to TB bacteria.

Multidrug-resistant tuberculosis (MDR-TB): TB caused by *Mycobacterium tuberculosis* strains that are resistant to at least both rifampicin and isoniazid.

New case: Newly registered episode of TB in a person who has never been treated for TB or has taken TB medicines for less than 1 month.

Non-severe pulmonary tuberculosis for the purpose of determining treatment duration for drug-susceptible tuberculosis: Intrathoracic lymph node TB without airway obstruction; uncomplicated TB pleural effusion or paucibacillary, non-cavitary disease confined to one lobe of the lungs and without a miliary pattern.

Number needed to screen: Number of people who need to undergo screening in order to diagnose one person with TB disease.

Operational research or implementation research: In the context of this handbook, applied research that aims to develop the critical evidence base that informs the effective, sustained and embedded adoption of interventions within a health system to improve health or patient outcomes. Such research deals with the knowledge gap between efficacy, effectiveness and current practice to produce the greatest gains in disease control.⁷ Operational research also provides decision-makers with information to enable them to improve the performance of their health programmes.⁸

⁶ GRADE is a transparent framework for developing and presenting summaries of evidence. It provides a systematic approach for making clinical and public health practice recommendations. Guyatt GH, Oxman AD, Vist GE, et al. GRADE: an emerging consensus on rating quality of evidence and strength of recommendations. *BMJ*. 2008;336:924.

⁷ Guide to operational research in programs supported by the Global Fund. Geneva: Global Fund to Fight AIDS, Tuberculosis and Malaria; 2007 (https://www.who.int/hiv/pub/operational/or_guide_gf.pdf, accessed 11 March 2022).

⁸ Expanding capacity for operations research in reproductive health: summary report of a consultative meeting. Geneva: World Health Organization; 2003 (https://apps.who.int/iris/bitstream/handle/10665/67936/WHO_RHR_02.18.pdf?sequence=1&isAllowed=y, accessed 11 March 2022).

Outpatient health care setting: Health care facility where people are undergoing diagnosis and receiving treatment and care but are not admitted for overnight stays (e.g. ambulatory clinic, dispensary).

Passive case-finding: Patient-initiated pathway to TB diagnosis involving a person with TB disease who experiences symptoms that they recognize as serious; the person having access to and seeking care, and presenting spontaneously at an appropriate health facility; a health worker correctly assessing that the person fulfils the criteria for presumptive TB; and successful use of a diagnostic algorithm with sufficient sensitivity and specificity to diagnose TB.

People who use drugs: People who engage in the harmful or hazardous use of psychoactive substances that could impact negatively on their health, social life, resources or legal situation.

Presumptive tuberculosis: Person who presents with symptoms or signs suggestive of TB.

Previously treated: People who have previously received 1 month or more of TB medicines. Previously treated people may have been treated with a first-line regimen for drug-susceptible TB or a second-line regimen for drug-resistant forms.

Programmatic management of tuberculosis preventive treatment: All coordinated activities by public and private health caregivers and the community aimed at scaling up TB preventive treatment to people who need it.

Pulmonary tuberculosis (PTB) (classification): Any bacteriologically confirmed or clinically diagnosed case of TB involving the lung parenchyma or the tracheobronchial tree, including tuberculous intrathoracic lymphadenopathy (mediastinal and/or hilar), without radiographic abnormalities in the lungs.⁹ Miliary TB is classified as PTB because there are lesions in the lungs. A person with both PTB and extrapulmonary TB should be classified as having PTB.

Rifampicin-resistant tuberculosis (RR-TB): TB caused by *Mycobacterium tuberculosis* strains resistant to rifampicin. These strains may be susceptible or resistant to isoniazid (i.e. MDR-TB) or resistant to other first-line or second-line TB medicines. In these guidelines and elsewhere, MDR-TB and RR-TB cases are often grouped together as MDR/RR-TB and are eligible for treatment with an MDR-TB regimen.

Rifampicin-susceptible, isoniazid-resistant tuberculosis: TB caused by *Mycobacterium tuberculosis* strains resistant to isoniazid and susceptible to rifampicin.

Serious adverse event: Adverse event that can lead to death or a life-threatening experience, to hospitalization or prolongation of hospitalization, to persistent or significant disability, or to a congenital anomaly. Serious adverse events that do not immediately result in one of these outcomes but that require an intervention to prevent such an outcome from happening are included. Serious adverse events may require a drastic intervention, such as termination of the medicine suspected of having caused the event.

Severe acute malnutrition: Presence of oedema of both feet or severe wasting (weight-for-height/length less than -3 standard deviations/Z-scores or mid-upper arm circumference less than 115 mm).¹⁰

Severe extrapulmonary tuberculosis: Presence of miliary (disseminated) TB or TB meningitis. In children and young adolescents aged under 15 years, extrapulmonary forms of disease other than lymphadenopathy (peripheral nodes or isolated mediastinal mass without compression) are considered to be severe.

⁹ Following a WHO expert consultation in September 2021, intrathoracic lymph node TB is now classified as pulmonary TB in children.

¹⁰ Pocket book of hospital care for children: guidelines for the management of common childhood illnesses, 2nd edition. Geneva: World Health Organization; 2013 (https://apps.who.int/iris/bitstream/handle/10665/81170/9789241548373_eng.pdf, accessed 27 September 2021).

Severe pneumonia: Cough or difficulty in breathing plus at least one of the following:

- central cyanosis or oxygen saturation <90% on pulse oximetry;
- severe respiratory distress (e.g. grunting, nasal flaring, very severe chest indrawing);
- signs of pneumonia with a general danger sign (inability to breastfeed or drink, persistent vomiting, lethargy or unconscious, convulsions, stridor in a calm child, severe malnutrition).⁸

Source case: Person with TB disease who infected others in a new setting. This could be the index patient or another person who was not identified.

Systematic screening for tuberculosis disease: Systematic identification of people at risk for TB disease in a predetermined target group by assessing symptoms and using tests, examinations or other procedures that can be applied rapidly. For those who screen positive, the diagnosis needs to be established by one or several diagnostic tests and additional clinical assessments. This term is sometimes used interchangeably with “active tuberculosis case-finding”. It should be distinguished from testing for TB infection (with a TB skin test or interferon-gamma release assay).

Treatment outcomes and relapse: Categories for treatment outcomes used in this operational handbook and the term “relapse” were applied according to the definitions agreed for use by TB programmes, unless otherwise specified.^{11,12}

Tuberculin skin test (TST): Intradermal injection of a combination of mycobacterial antigens that elicit an immune response (delayed-type hypersensitivity), represented by induration, which can be measured in millimetres. TST is used to diagnose TB infection.

Tuberculosis (TB): Disease state due to *Mycobacterium tuberculosis*. In this handbook, it is commonly referred to as “TB disease” to distinguish it from “TB infection”.

Tuberculosis infection: State of persistent immune response to stimulation by *Mycobacterium tuberculosis* antigens with no evidence of clinically manifest TB disease. This is referred to as “TB infection” as distinct from “TB disease”. There is no gold standard test for direct identification of *M. tuberculosis* infection in humans. Most infected people have no signs or symptoms of TB but are at risk for TB disease. The term “latent TB infection” has been replaced by the term “TB infection”.

Tuberculosis preventive treatment (TPT): Treatment offered to people considered at risk of TB disease to reduce that risk. Also referred to as “treatment of TB infection” or “TB preventive therapy”.

Underweight: Among adolescents, this usually refers to a body mass index below 18.5. Among children aged under 10 years, it usually refers to a weight-for-age Z-score below –2 standard deviations.

¹¹ Definitions and reporting framework for tuberculosis – 2013 revision. Geneva: World Health Organization; 2013 (WHO/HTM/TB/2013.2; http://apps.who.int/iris/bitstream/10665/79199/1/9789241505345_eng.pdf, accessed 11 March 2022).

¹² Meeting report of the WHO expert consultation on drug-resistant tuberculosis treatment outcome definitions, 17–19 November 2020. Geneva: World Health Organization; 2021 (<https://apps.who.int/iris/rest/bitstreams/1336957/retrieve>, accessed 11 March 2022).

1. Introduction

1.1. Background

Tuberculosis (TB) is a preventable and curable disease, but it continues to impact the lives and development of millions of children and adolescents. Children and young adolescents aged under 15 years represent about 11% of all TB cases globally. This means 1.1 million children and young adolescents aged under 15 years fall ill with TB every year (1).

National tuberculosis programmes (NTPs) notify less than half of these children, and there is a large case detection gap of children who are not diagnosed and/or not reported. The gap is largest in children aged under 5 years. Reasons for this gap include challenges with specimen collection and bacteriological confirmation of TB in young children due to the paucibacillary nature of TB in this age group and the lack of highly sensitive point-of-care diagnostic tests. Children and adolescents usually access primary health care (PHC) or child health services, where capacity to recognize presumptive TB and access to diagnostic services are limited. In addition to the case detection gap, only a third of child contacts aged under 5 years eligible for tuberculosis preventive treatment (TPT) actually received it in 2020 (1).

TB is also common in adolescents, especially older adolescents aged 15–19 years, with an estimated half a million cases globally each year (2). TB has a major impact on the health and well-being of adolescents. Unlike young children, adolescents are an important risk group for transmission due to infectiousness of disease and high social mobility.

This operational handbook is published alongside the *WHO consolidated guidelines on tuberculosis. Module 5: management of tuberculosis in children and adolescents* (3), which include the latest evidence-based recommendations related to the prevention and management of TB in children and adolescents.

Surveillance data traditionally refer to children as people aged under 15 years, but the populations of interest in the consolidated guidelines and operational handbook are defined as follows:

- A child is a person aged under 10 years.
- An adolescent is a person aged 10–19 years (inclusive).

1.2. Children and adolescents as a key vulnerable population

Children can present with TB disease at any age, but most commonly between the ages of 1 and 4 years in high TB burden settings. Children who develop TB disease usually do so within a year of TB infection. The presentation of TB in children is an indicator of recent and ongoing transmission of *Mycobacterium tuberculosis* in the community (4).

Infants and young children, especially those aged under 2 years, are at higher risk of developing disseminated disease and tuberculosis meningitis (TBM), which are associated with high morbidity and mortality (4). Adolescents with TB usually present with infectious TB disease, as typically seen in adults

(e.g. with cavities on chest X-ray (CXR) and bacteriologically confirmed disease) (5). Adolescents also form a particularly vulnerable group who face important psychosocial challenges, requiring careful consideration of their growing autonomy, specific adherence support, and assistance with transitioning from paediatric to adult health service provision (5, 6).

1.3. Rationale and objectives of this operational handbook

The aim of this operational handbook is to provide practical guidance on the implementation of the World Health Organization (WHO) policy recommendations on the prevention and management of TB in children and adolescents under programmatic circumstances and at different levels of the health system.

The practical guidance aims to inform the development or revision of national policies and related implementation guidance (e.g. handbooks, standard operating procedures) on the management of TB in children and adolescents. This handbook can also help countries adequately plan for the uptake of interventions to better address the specific needs of children and adolescents with or at risk of TB. It can contribute to national efforts to build capacity among national and subnational programme managers and among health workers at all levels of the health care system.

The desired overall impact of WHO normative guidance on the management of TB in children and adolescents is a reduction in the burden of TB morbidity and mortality in children and adolescents, in line with the targets included in the WHO End TB Strategy (7), goal 3 of the United Nations Sustainable Development Goals (SDGs) (8) and the Political Declaration of the United Nations General Assembly High-level Meeting on the Fight against Tuberculosis (9). At the High-level Meeting, heads of states committed for the period 2018–2022 to successfully treat 3.5 million children and young adolescents aged under 15 years with TB and 115 000 children and young adolescents with drug-resistant TB; and to provide TPT to at least 30 million people, including 4 million children aged under 5 years, 20 million other household contacts, and 6 million people (including children and adolescents) living with HIV (9). To reach these targets, multisectoral engagement, actions and accountability are needed.

1.4. Preferences of end-users regarding content and structure of this operational handbook

In preparation for the development of the WHO consolidated guidelines and operational handbook on the management of TB in children and adolescents, a survey was conducted among end-users to:

- collect perspectives on the barriers and facilitators for the implementation of WHO recommendations on the management of TB in children and adolescents;
- understand respondents' preferences regarding the content and structure of the operational handbook;
- inform dissemination approaches.

Respondents ($N = 182$) were from NTPs, United Nations organizations and technical organizations, with a limited number from national human immunodeficiency virus (HIV), nutrition, maternal, child and adolescent health, and PHC programmes. The majority of respondents worked in high TB burden, TB/HIV coinfection or multidrug-resistant tuberculosis (MDR-TB) countries.

Respondents indicated it would be useful for the operational handbook to include dosing and practical implementation guidance (e.g. standard operating procedures for tuberculin skin tests (TST) and specimen collection methods). Consolidation of all recommendations related to the prevention and management of TB in children and adolescents in one document was considered important. The following were indicated as priorities:

- specific guidance on management of vulnerable children, including children with comorbidities and malnutrition, with case studies and best practices;
- details on the differences in managing children and adults with or at risk of TB;
- practical advice on when and how to initiate TB treatment;
- guidance on managing comorbidities and side-effects of medicines;
- guidance on nutrition for children and adolescents with TB;
- alignment and harmonization with policy recommendations from guidelines in other programmes (e.g. HIV, maternal, newborn, child and adolescent health, nutrition);
- guidance on community involvement;
- optimal engagement of patients, parents and caregivers, and social support for families affected by TB.

Respondents requested translation of the guidelines and operational handbook into multiple languages and indicated that electronic versions of the consolidated guidelines and related operational handbook would be useful. They highlighted the importance of dissemination during webinars (e.g. on World TB Day), regional consultations involving national programmes and national paediatric associations, and international symposia and conferences. Development of user-friendly online training materials was considered useful to increase access.

1.5. Structure of the operational handbook

The chapters in the handbook are structured around the pathway of TB infection and disease in an individual child or adolescent and the interface with and retention across sequential stages of care (cascade of care), as shown in Figure 1.1 (5).

Figure 1.1. Pathway through TB exposure, infection and disease

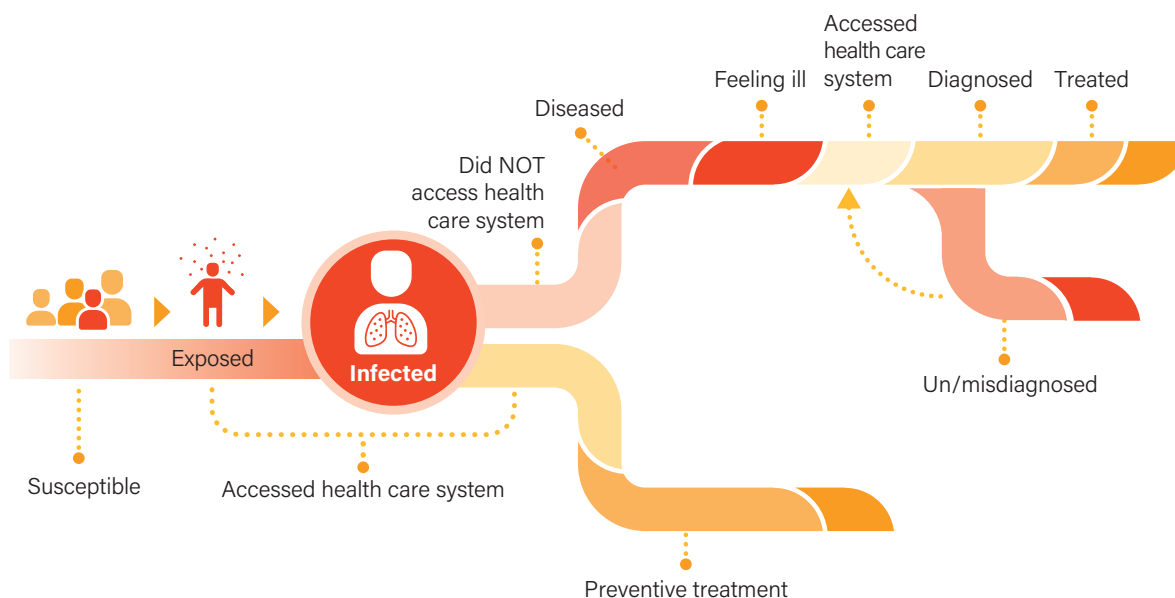

Source: Roadmap towards ending TB in children and adolescents. Geneva: World Health Organization; 2018 (<https://apps.who.int/iris/handle/10665/275422>).

The pathway involves multiple steps, from exposure to a person with an infectious form of TB, leading to subsequent TB infection and, for some people, progression to TB disease. Each of the steps requires evidence-based interventions to reduce TB transmission, prevent TB disease, enable early and accurate diagnosis of TB disease, and optimize treatment outcomes for children and adolescents

with drug-susceptible TB or drug-resistant tuberculosis (DR-TB). The steps should take place in the context of child-, adolescent- and family-friendly health care services.

Chapter 2 covers TB screening and contact investigation as the first step in the cascade of care. Chapter 3 on TB prevention in children and adolescents covers bacille Calmette-Guérin (BCG) vaccination, TPT and TB infection prevention and control. Chapter 4 covers the diagnosis of pulmonary tuberculosis (PTB) and extrapulmonary tuberculosis (EPTB) (both drug-susceptible and drug-resistant forms), including the use of diagnostic tests and how to make a decision to start TB treatment based on integrated treatment decision algorithms for use in different settings. The chapters on the cascade of care conclude with Chapter 5 on the treatment of drug-susceptible and drug-resistant PTB and EPTB, with a section on post-TB health. Figure 1.1 is presented at the beginning of each chapter, highlighting the part of the pathway being addressed by the chapter. Chapter 6 covers models of care to improve TB service delivery in line with the special needs of children, adolescents and families. Chapter 7 is on special situations and provides practical guidance on the management of TB in children and adolescents living with HIV; TB in pregnancy and management of babies born to women with TB disease; palliative care for children and adolescents with TB; care for adolescents with or at risk of TB; TB in children with pneumonia; and TB in children with malnutrition.

The annexes include resources, practical tools and standard operating procedures.

Recommendations for which this operational handbook provides operational guidance use the strength (and quality of evidence) as indicated in the [consolidated guidelines on the management of TB in children and adolescents \(and relevant source guidelines\)](#).

A strong recommendation is one for which there is confidence that the desirable effects clearly outweigh the undesirable effects. In this case, the recommendation is formulated using the word “should”.

A conditional recommendation is one for which the guideline development group concluded that the desirable effects probably outweigh the undesirable effects or are closely balanced, but the group was not confident about these trade-offs in all situations. Conditional recommendations are formulated using the word “may” (see [web annex 1 of the consolidated guidelines on the management of TB in children and adolescents](#)).

Although the aim is for harmonization of age definitions for children and adolescents, the age cut-offs for recommendations in this handbook were informed by the evidence available at the time it was reviewed and were based on the source guidelines. Throughout the operational handbook, boxes with recommendations are indicated with a green colour, key points are in light blue and examples, case studies and useful resources in light orange.

1.6. Target audience

The target audience for this handbook includes NTPs and other child health programmes that provide care for children with or at risk of TB, including maternal, newborn, child and adolescent health programmes, HIV services, and PHC programmes. The handbook also targets paediatricians and other health care workers (HCWs) in the public and private sectors, school health services, civil society and community-based organizations, and health care educators.

2. TB screening and contact investigation

2.1. Introduction

About a quarter of the world's population has been infected with *Mycobacterium tuberculosis*. The vast majority of these people do not have TB disease (10). It is estimated that 7.5 million children and young adolescents aged under 15 years are newly infected with *M. tuberculosis* each year (11). Cumulatively, about 67 million children and young adolescents aged under 15 years are infected with *M. tuberculosis*, including 2 million with MDR-TB and 100 000 with extensively drug-resistant tuberculosis (XDR-TB) strains, and therefore at risk of developing TB disease (12). The risk of infection is greatest if exposure to a person with TB disease is close and prolonged (e.g. exposure of an infant or toddler to the mother or other caregiver in the household) (6).

Contact investigation is the systematic identification of people, including children and adolescents, with previously undiagnosed TB disease and TB infection among the contacts of a TB patient. TB exposure usually follows household or other close contact with a person (usually an adolescent or adult) with bacteriologically confirmed PTB. Contact investigation and management consist of identification of close contacts, clinical evaluation, testing (where possible), and provision of appropriate TB treatment (for people with TB disease) or TPT (for people without TB disease but with proven or suspected TB infection) (13).

If the index case is a child, it is recommended that contact investigation and screening include efforts to identify the likely source of infection. This is known as "reverse contact investigation" or "source case investigation" (6). The terms "contact investigation" and "contact evaluation" are often used synonymously with "contact tracing". In the context of TB, however, action beyond identifying contacts is critical (13), and this handbook uses the term "contact investigation".

Implementation of effective algorithms for TB screening and provision of TPT or disease treatment, as appropriate, can improve the health of exposed individuals and the community in general (13).

Systematic screening for TB disease is the systematic identification of people at risk for TB disease, in a predetermined target group, by assessing symptoms and using tests, examinations or other procedures that can be applied rapidly. In people who screen positive, the diagnosis needs to be established by one or several diagnostic tests and additional clinical assessments (see [Chapter 4](#)). The term "systematic screening for TB disease" is sometimes used interchangeably with "active TB case-finding" (14). The aim is to detect TB disease early in order to minimize delays in treatment initiation, thereby reducing health sequelae for the patient, ongoing TB transmission within the community, and adverse social and economic consequences of TB for individuals and their families. Contact investigation is therefore a form of systematic screening for TB, but it also includes identification of (likely) TB infection and provision of TPT.

Early diagnosis of TB, including universal drug susceptibility testing (DST), systematic screening of contacts and high-risk groups, and preventive treatment of people at high risk for TB disease, are key components of Pillar 1 (integrated patient-centred care and prevention) of the WHO End TB

Strategy (7). Detecting TB only among people who present to health facilities is not enough to find all people with TB disease. The remaining case detection gap (particularly in children and adolescents), persistence of diagnostic delays resulting in morbidity and mortality, and continued transmission in the community indicate the need for a more active approach to the early detection of TB. This justifies systematic screening of selected risk groups and populations for TB disease (5, 13).

This chapter relates to the section of the pathway highlighted in blue in Figure 2.1. It provides implementation guidance on WHO recommendations on TB contact investigation and screening that apply to children and adolescents. It also provides some examples of successful approaches.

Figure 2.1. Pathway through exposure, infection and disease covered in Chapter 2

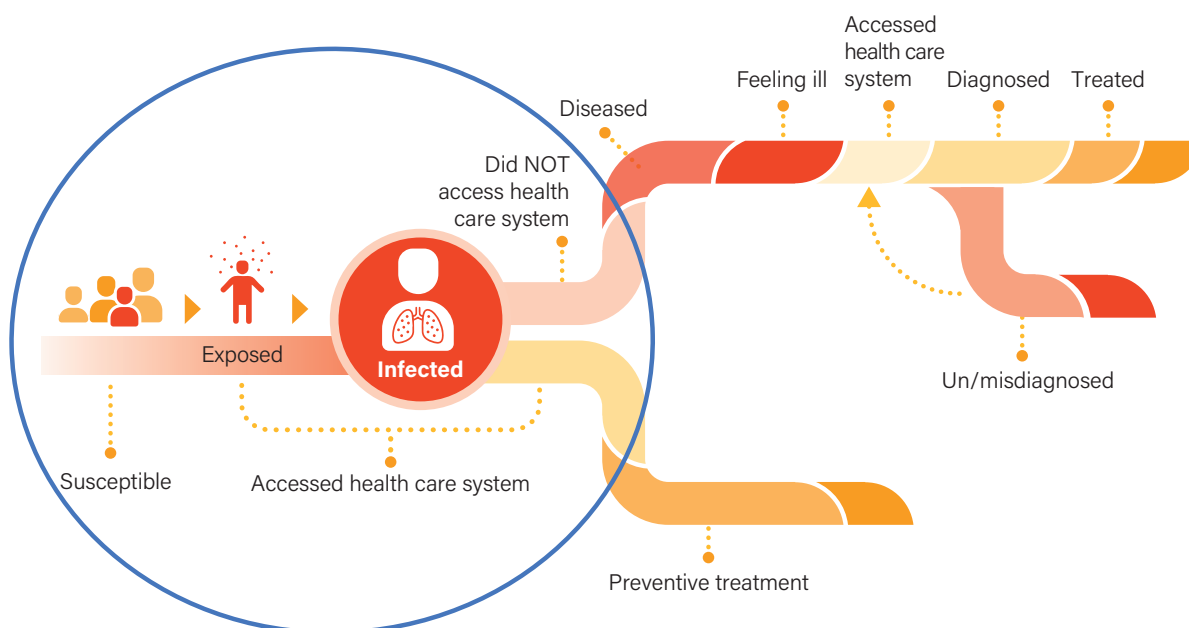

Source: Roadmap towards ending TB in children and adolescents. Geneva: World Health Organization; 2018 (<https://apps.who.int/iris/handle/10665/275422>).

2.2. Contact investigation

2.2.1. Prioritizing household contacts

Household contacts of people with PTB are a well-recognized group at risk for TB infection and TB disease, including prevalent TB detected at the time of initial contact investigation and incident TB that occurs within the subsequent 2–5 years (75). WHO recommends that household contacts and other close contacts of people with PTB should be systematically screened for TB disease (74). Contact investigation can be implemented at the health facility, in the community or through a combination of these approaches.

A systematic review and meta-analysis estimated the risk of developing TB disease in children (defined in this study as people aged under 19 years) after close exposure and how this risk was affected by TPT, BCG vaccination and time since TB exposure (76). The review found that exposed infants who had evidence of TB infection and did not receive TPT had an 18% risk of developing TB disease within 2 years of being evaluated as a contact. In contrast to previous estimates that suggested the risk is lower for children aged 2–5 years, this study found that this age group had an equally high risk of developing TB within 2 years (19%). The effectiveness of TPT to prevent the development of TB disease was estimated at 91% for children and adolescents with TB infection.

Another important finding of the review was that 61% of children and adolescents and 83% of all children aged under 5 years with TB infection who developed TB disease did so within weeks of the initial contact investigation.

The review confirmed that younger children, especially those aged under 2 years, are at particularly high risk of TB disease progression after infection (4), and that contact investigation reaches many children too late to prevent disease. Considering that 80% of paediatric deaths from TB occur in children aged under 5 years (17), earlier diagnosis of infectious adults and timely TB screening, diagnosis and treatment of children who are contacts are important approaches to reduce TB disease and deaths in children (16).

Other studies also highlight the importance of contact investigation. Results of the PHOENIX feasibility study from eight high TB burden countries showed that contact investigation helped detect new TB disease in 12% of contacts. The prevalence of TB infection (defined as either TST or interferon-gamma release assay (IGRA) positivity) in this group was 72% (18). Thus, screening household contacts for TB disease is considered a high priority because it is a high-yield, cost-effective strategy (19). Contact investigation links to effective interventions such as treatment for TB disease and TPT, helps prevent transmission, and improves TB treatment outcomes for contacts. It is also a key strategy for TB infection prevention and control.

Investigation and treatment of all household contacts can provide important health and financial benefits for the family. The occurrence of TB in a family can have serious social and economic effects, including catastrophic costs due to loss of income or charges for health care. Offering TPT to all household members at the same time and during the period when the index patient is still receiving treatment and care can help maximize the understanding and impact of TPT and enhance cost-effectiveness of interventions such as home visits.

WHO recommendations on HIV testing for TB contacts are listed in [Box 2.1](#).

Box 2.1 WHO recommendations on contact investigation and HIV testing

In settings of high HIV prevalence, all household and close contacts of people with TB should be counselled and tested for HIV (*strong recommendation, very low certainty of evidence*).

In settings of low HIV prevalence, all household members and close contacts of people with TB who have symptoms compatible with TB disease may be offered counselling and testing for HIV as part of their clinical evaluation (*conditional recommendation, very low certainty of evidence*).

All household contacts of an index case who is a person living with HIV should be counselled and tested for HIV (*strong recommendation, very low certainty of evidence*).

Source: Recommendations for investigating contacts of persons with infectious tuberculosis in low- and middle-income countries. Geneva: World Health Organization; 2012 (<https://apps.who.int/iris/handle/10665/77741>).

Key point: contact investigation

Contact investigation helps to identify people with undiagnosed TB, thus reducing treatment delays and onward transmission. It is also key to preventing TB by improving access to TPT for child, adolescent and adult contacts.

2.2.2. Planning and budgeting to implement or strengthen household contact investigation

Contact investigation to identify children, adolescents and other household members with TB disease and to identify those who will benefit from TPT should be a standard component of all national TB programmes. Contact investigation is good public health practice and essential to address and manage several infectious diseases such as coronavirus disease 2019 (COVID-19).

Health ministries should invest in strengthening health system capacity to undertake contact investigation. If mechanisms to undertake contact investigation are already in place to identify young children and people living with HIV with TB disease and TB infection, national programmes can strengthen the same mechanisms to ensure contacts aged 5 years and over are also covered. If such mechanisms are lacking, the health ministry should dedicate the necessary human and financial resources to establish effective mechanisms for contact investigation (15).

Box 2.2 provides information on a budgeting tool for contact investigation that aids health ministries and other organizations considering the establishment or expansion of contact investigation activities.

Box 2.2 Paediatric TB Operational and Sustainability Expertise Exchange budgeting tool for household contact investigation

In 2020, the Paediatric TB Operational and Sustainability Expertise Exchange (POSEE) task force, a time-limited task force of the Child and Adolescent TB Working Group, developed tools to help countries budget for dedicated key paediatric TB interventions, including household contact investigation, development of training materials, implementation of training programmes, TPT (including use of shorter TPT regimens), and sample collection procedures to support bacteriological confirmation. The budgeting tools are available as single tools or embedded within the WHO One Health TB module companion book.

The household contact investigation tool focuses on costs related to the additional health workers required for household contact investigation, training of health workers to perform contact investigation, community sensitization campaigns, linkage of child contacts aged under 5 years to facilities for TPT initiation, and monitoring and evaluation related to household contact investigation. The tool does not include costs related to linkage of contacts aged 5 years and over to facilities for TPT initiation, as recommended by WHO, or costs incurred at the level of general TB programming.

Source: Costing of dedicated key interventions towards ending TB in children. Geneva: Stop TB Partnership; 2020 (http://stoptb.org/wg/dots_expansion/childhoodtb/posee.asp).

Figure 2.2 lists the items to consider for determining appropriate unit costs for budgeting and planning to strengthen contact investigations (15).

Figure 2.2. Costing items to strengthen contact investigation

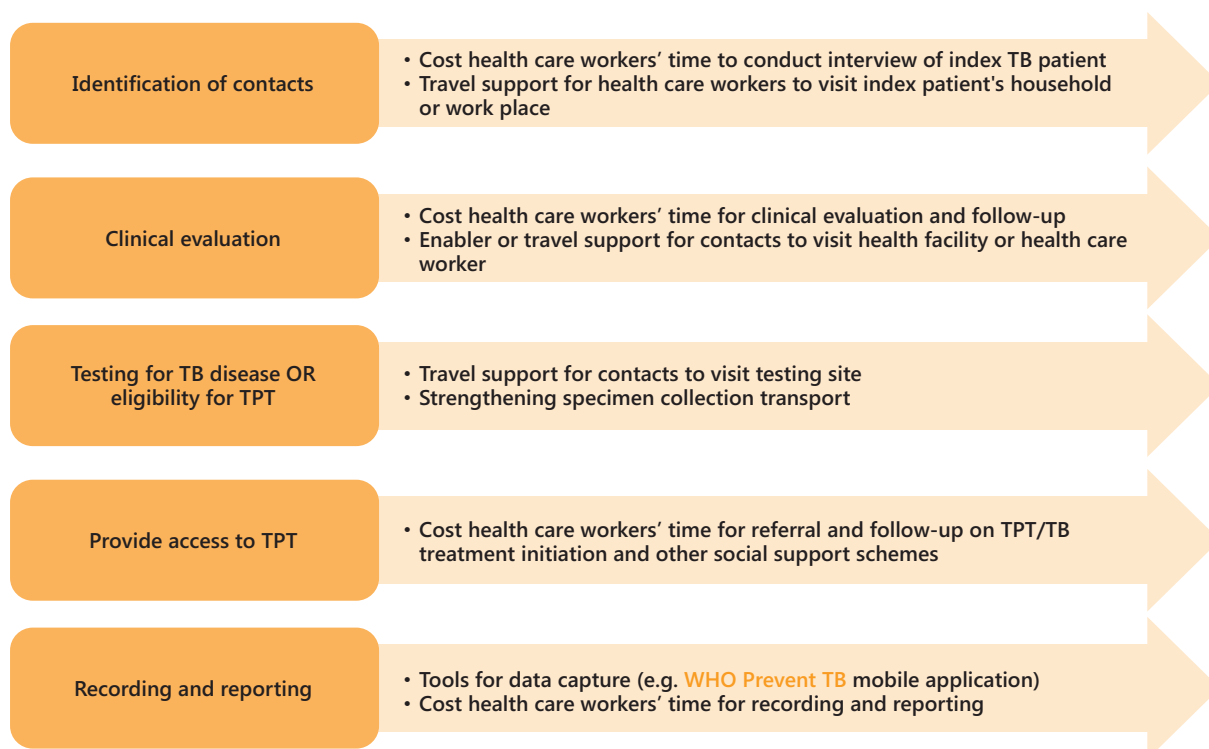

2.2.3. Key implementation steps in contact investigation

In addition to planning and budgeting, NTPs should consider the following key implementation steps in contact investigation:

1. Provide standard guidance and approaches to reach contacts and undertake investigations to ensure uniformity in implementation.
2. Provide national guidance that:
 - defines priority populations for contact investigation (household and beyond);
 - defines the model of care (facility- or community-based);
 - ensures the human rights of index patients, contacts and communities are respected;
 - defines the roles and responsibilities of programme personnel, HCWs and community health workers (CHWs) in reaching contacts, symptom screening and provision of CXR if available, referral for testing and clinical evaluation (e.g. cadre of HCWs responsible for contact investigation and inclusion in respective job descriptions, or HCWs responsible for supervision of personnel conducting contact investigation if community-based model is implemented);
 - defines data elements to be captured with the index patient's record (with or without use of digital tools);
 - includes the necessary tools to identify contacts, to record the outcomes of TB screening, and to refer identified people with presumptive TB for further diagnostic workup if the community-based model is implemented;
 - provides locally tested messages for demand generation and education.
3. Leverage existing human resources and mechanisms across multiple disease programmes (e.g. public health response model and differentiated service delivery (DSD) models for people living with HIV) to implement contact investigation and ensure sustainability and efficiency. TB and HIV screening could be integrated throughout the process.

4. Implement contact investigation as follows:

- The index patient should be interviewed as soon as possible after diagnosis, preferably within a week, to elicit details about household and other close contacts. Health providers should explain clearly and sensitively the urgency of initiating contact investigation to the index patient, considering the increased risk of progression to TB disease with recent exposure. A second interview may be required to elicit additional contacts and to complete any missing information.
- Ideally, the interview should be conducted by a person who speaks the same language as the index patient and is familiar with their social and cultural context.
- Education of the index patient and household members regarding the benefits of taking TPT and the risks of not taking it should be central to the contact investigation process. The overall aim should be to enable informed decision by the individuals to receive a complete course of TPT.
- Appropriate disclosure counselling of the index TB patient is important to secure their support and to reach all relevant contacts for investigation.
- Contact investigation can be implemented in the community or at the health facility. Where the community-based model is implemented, it is desirable to seek approval from the index patient for a home visit. In addition to counselling of the index patient, arrangements should be made to counsel contacts before starting TPT.
- Preferably, the health provider (trained CHW or professional health provider) conducting the contact investigation should visit the home or workplace of the index patient; conduct interviews and underscore the importance of identifying and evaluating contacts; perform symptom screening and documentation; gather more accurate information about the likely intensity and duration of exposure; and ensure all symptomatic contacts are referred for further evaluation and treatment decision and all asymptomatic contacts are assessed for TPT eligibility (see Box 2.3) (20). Home visits may need to be done outside working hours since contacts may be at work or school during these times.
- Home visits by health providers provide the opportunity to identify needs for social support, nutritional support and information on infection control measures. The health provider may refer the index patient and contacts to relevant social and nutritional support programmes.
- During the home visit, the health provider should provide counselling and education to family members on TB symptoms and infection control (see [Annex 1](#) for a list of resources, including counselling and education materials). If required, prompt medical attention and referrals should be made, especially for child contacts and people living with HIV, in whom TB could progress rapidly. HIV testing and counselling should be offered as part of this process, including to biological children of any adults living with HIV.
- If the home or workplace cannot be visited, the index patient may be interviewed at a health facility and their contacts listed. The index patient's full address should be obtained and modality for future communication mutually agreed with them (e.g. telephone, email, contact of an intermediary or treatment provider). Health workers should systematically follow up with the index patient, intermediary and treatment providers and mobilize all relevant contacts to the health facility for symptom screening and CXR where relevant, testing for TB and TB infection when indicated and available, and evaluation for eligibility for TPT. Transport vouchers may be needed if this is done at a clinic.
- The focus of the contact investigation should be on household members, but contacts at workplaces, residential care facilities, residential schools, long-term care facilities, prisons, correctional facilities and acute medical care facilities should also be considered as per national guidelines for evaluation, especially when exposure is likely to have been prolonged and the index case is likely to be highly infectious (prolonged cough, medium or high semiquantitative results via rapid molecular testing, or extensive cavities on CXR).
- Maintaining confidentiality during contact investigation is a challenge because of the social connections between index patients and their contacts. All people should be treated with respect, and confidentiality should be maintained as much as possible. National programme guidelines on data protection, confidentiality, privacy and informed consent should be adhered

to. Contact screening is generally experienced in a positive light if the community appreciates this is done to keep vulnerable people and the whole community safe (21).

- When the index patient is reluctant to give information regarding household and social contacts, counselling efforts should continue over time to gain the patient's trust. The index patient should not be coerced, and their TB treatment should not be linked with the success of the contact investigation.
- Information from the interview should be recorded in the patient's medical notes or file (22).
- If not already done, contact investigation is also important among family members and close contacts of a person who has died from TB.

5. Provide guidance on monitoring and evaluation:

- Use standard recording and reporting tools and a protocol for data collection during contact investigation, data entry and analysis.
- Monitor the yield of contact investigations and the number and proportion of people with TB disease and TB infection detected to inform programme adjustments. Information should be recorded on the number of contacts identified and those who complete the contact investigation process.

Key point: respecting privacy and human rights

People with TB should not be compelled to disclose contacts or help ensure completion of contact investigation. Due diligence is necessary to safeguard the privacy, confidentiality and human rights of all people involved in contact investigation and to avoid stigma and discrimination.

Box 2.3 Key steps in contact investigation

The following steps in contact investigation are important (not necessarily in the order listed):

- ➔ Review available information on the index patient.
- ➔ Assess the duration and degree of infectiousness of the index patient to identify contacts.
- ➔ Counsel the index patient and enumerate household and close contacts.
- ➔ Develop a plan for contact investigation in consultation with the index patient or their parent or guardian.
- ➔ Consider other contacts for investigation.
- ➔ Conduct home visits or invite contacts to the health centre for screening for TB infection or TB disease.
- ➔ Conduct a clinical assessment of contacts and refer for testing for TB infection or TB disease, and for HIV testing as appropriate.
- ➔ Provide treatment for TB disease or TPT as per eligibility, and provide ongoing support until treatment completion.
- ➔ Review the completeness of the contact investigation and attempt to follow up on missing contacts and complete missing information.
- ➔ Ensure systematic recording and reporting of the whole contact investigation process.

2.2.4. Examples of facility- and community-based approaches for TB contact investigation

TB contact investigation can be implemented at the health care facility or at the community level, or as a combination. This section contains some examples of approaches to contact investigation, including lessons learnt.

Box 2.4 The Catalyzing Pediatric Tuberculosis Innovation project

In nine countries of sub-Saharan Africa (Cameroon, Côte d'Ivoire, Democratic Republic of the Congo, Kenya, Lesotho, Malawi, Uganda, United Republic of Tanzania, Zimbabwe), the Elizabeth Glaser Pediatric AIDS Foundation supported implementation of systematic household contact investigation within the framework of the Unitaids-supported Catalyzing Pediatric Tuberculosis Innovation (CaP-TB) project between 2017 and 2021.

The project targeted children and adolescents aged under 15 years identified as contacts of index TB cases. TB index cases were defined according to national guidelines. WHO is now recommending TPT for all eligible household contacts, but the target population for TPT in the project followed the national guidelines in place and therefore included child contacts aged under 5 years irrespective of HIV status and contacts living with HIV aged 5–14 years. To assess the effectiveness of project interventions, a pre- and post-intervention evaluation was performed.

Household contact investigation was conducted using facility- or community-based approaches, depending on the country and the context. In facility-based models, index TB cases were asked to bring their household child contacts to the facility to perform TB screening, assess eligibility for TPT for asymptomatic children, and evaluate those with symptoms for TB disease.

In the community-based model, the TB nurse or TB focal person provided CHWs with regularly updated lists of index TB cases who declared having children in the household. CHWs conducted household visits and provided TB screening and initial TPT eligibility assessment at the community level using a project-specific form that included a child-adapted screening tool. The symptom screen included cough for more than 2 weeks; fever for more than 10 days; weight and/or appetite loss or failure to thrive during the past 3 months; fatigue, manifested as reduced playfulness, or lethargy; night sweats for more than 2 weeks (for children aged over 10 years); and neck swelling. In addition, history of close TB contact during the past 12 months was explicitly asked. Asymptomatic children aged 0–4 years irrespective of HIV status and children and young adolescents living with HIV aged 5–14 years were referred to the facility to confirm TPT eligibility and to start TPT. Symptomatic children of all ages were referred to the facility for further clinical assessment and diagnosis.

Key components of the intervention included provision or strengthening of human resources dedicated to TB contact investigation; initial and refresher training on contact investigation to CHWs and HCWs; on-site coaching and supervision by project staff or staff from the health ministry; reimbursement of costs related to transport and food to CHWs and (in some countries) vouchers or reimbursement for transport for the child's caregiver to visit a facility; introduction, development or validation of national tools for recording and monitoring contact investigation activities; patient education and sensitization on the importance of contact investigation and TPT; and provision of shorter TPT regimens (3 months of isoniazid and rifampicin daily, 3HR) if authorized by national health authorities. [Table 2.1](#) summarizes some of the key implementation challenges faced and mitigation actions implemented by the project.

Table 2.1 Challenges and mitigation actions

Challenges	Mitigation actions
Lack of financial resources for contact investigation activities	Provision of dedicated resources through the project Advocacy targeting national authorities and major bilateral donors to mobilize and ensure sufficient funding to support contact investigation interventions Development of contact investigation budgeting tool led by the Pediatric TB Operational and Sustainability Expertise Exchange (POSEE) Taskforce to support adequate estimation of resources needed
Lack of dedicated human resources for contact investigation	Hiring of additional CHWs through project funding Establishment of strong collaborations with civil society organizations to support contact investigation activities (volunteers were assigned to facilities to perform community-based contact investigation under the coordination of the TB focal point) Prioritization of contact investigation activities by district leadership
Transportation costs for caregivers and children to reach facilities, including long distances to travel to a facility, and inaccessibility due to road conditions in certain contexts (particularly in the facility-based model)	Implementation of a mixed model for contact investigation: targeted community-based contact investigation for TB index patients who did not bring their child contacts to the facility for further assessment
Child contacts not always declared by index cases	Retraining of TB focal points to enhance capacity for communication with TB index cases on the importance of identifying and screening for TB of all contacts The community-based model was found to be the best approach to minimize the number of child contacts missed
Parents and caregivers do not always agree to start children on TPT when they do not feel their children are sick	Development of information, education and communication material for parents to explain and emphasize the importance of initiating and adhering to TPT Retraining of TB focal points to enhance capacity for communication with parents and caregivers on importance of initiating and adhering to TPT
Travelling time and distances for CHWs, which had an impact on the time and human resources needed to conduct community-based contact investigation	Provision of food and transport reimbursements to CHWs Revision of number of CHWs assigned to health facilities based on distance and travelling times to communities in the facility catchment area
Consultation fees (for further investigation or TPT initiation of child contacts at facility level)	Advocacy towards national authorities and district leadership to remove fees for the paediatric population Removal of fees was achieved in some of the countries where this had emerged as a challenge for proper access to TB care

A number of lessons were identified during implementation of the project:

- Dedicated human resources are key to the success of contact investigation. Integration with community-based initiatives for other diseases is feasible only if human resource needs are adequately assessed and planned for.
- The choice of facility- or community-based model needs to be adapted to the context. Community-based models should generally be prioritized because they are more patient-centred, but a mixed model can be considered if resources are limited or when communities are not comfortable with household visits.
- Effective planning and coordination of contact investigation are crucial – particularly between TB nurses, TB focal persons and CHWs – and a clear role for stakeholders must be defined.
- Initial and refresher training on contact investigation and TPT for CHWs is necessary. CHWs who were previously treated for TB can play an important role in implementation.
- Regular on-site coaching of contact investigators, especially at the initial stage, is crucial and requires the involvement of the TB nurse or TB focal person.
- Sharing of experiences among CHWs helps to improve the performance of contact investigation.
- Establishment of facility-based targets for contact investigation, in consultation with facility staff, may help to keep frontline HCWs engaged and improve the performance of contact investigation.
- Introduction and use of specific monitoring tools such as contact tracing registers supports implementation of contact investigation by enabling accurate listing of contacts and monitoring and supervision of the contact investigation cascade of care.
- Transport arrangements or reimbursement for CHWs is key to the success of contact investigation, especially to reach contacts in remote locations.
- Community sensitization on the importance of contact investigation is helpful to facilitate the work of CHWs at the community level.

Source: Child contact investigation of index TB cases and TB preventive treatment: CaP-TB experiences in sub-Saharan African countries (unpublished data).

Box 2.5 Vikela Ekhaya: a novel community-based TB contact management programme in a high TB burden setting

In 2019, Baylor College of Medicine implemented Vikela Ekhaya, a novel community-based TB contact management programme in Eswatini designed to reduce barriers to accessing TPT. The programme offered differentiated TB and HIV testing for household contacts of people with TB by using mobile contact management teams to screen contacts, assess their TPT eligibility, and initiate and monitor TPT adherence in participants' homes. In total, 945 contacts from 244 households were screened for TB symptoms, 72 contacts (8%) reported TB symptoms, and 5 contacts (0.5%) were diagnosed with TB.

A total of 322 of 330 eligible asymptomatic household contacts (98%) initiated TPT. Of these 322 contacts, 248 children initiated 3 months of isoniazid and rifampicin, and 74 children and adults living with HIV initiated 6 months of isoniazid. A total of 298 (93%) completed TPT. Unknown HIV status (adjusted odds ratio (aOR) 5.7, $P = 0.023$), HIV-positive status (aOR 21.1, $P = 0.001$), living in an urban setting (aOR 5.6, $P = 0.006$) and low income (aOR 5.9, $P = 0.001$) predicted loss from the cascade of care among contacts eligible for TPT.

Vikela Ekhaya demonstrated that community-based TB household contact management is a feasible, acceptable and successful strategy for TB screening and TPT delivery. The results of the study support the development of locally adapted, novel, differentiated, community-based interventions for TB prevention and care.

Source: Kay AW, Sandoval M, Mtetwa G, et al. Vikela Ekhaya: a novel, community-based, tuberculosis contact management program in a high burden setting. *Clin Infect Dis.* 2021 (21).

Box 2.6 The Community Intervention for Tuberculosis Active Contact Tracing and Preventive Therapy study

The Unitaid-funded CaP-TB project Community Intervention for Tuberculosis Active Contact Tracing and Preventive Therapy (CONTACT) study is a cluster-randomized control study implemented by the Elizabeth Glaser Pediatric AIDS Foundation in Cameroon and Uganda in October 2019–June 2022. The community-based intervention for contact investigation was developed based on interviews with health care providers, community leaders and focus group discussions. These interviews revealed barriers to health facility contact screening and provision of TPT, including transport costs, distance of travel, competing priorities, prevention not always being considered by parents or caregivers to be a priority for children in good health, and fear of disclosure. Health providers also identified communication with patients as a barrier to child contact screening due mainly to a high workload and lack of education in informing people newly diagnosed with TB.

The following prerequisites for implementation of a community-based model for child contact investigations were identified:

- training for CHWs in conduct and motivation;
- checklists for symptoms, adherence and tolerability of TPT;
- secure transport for CHWs;
- dispensing of medicines at health facilities;
- use of TPT cards;
- good communication between TB focal persons and CHWs;
- good communication with index TB cases.

Strengths in implementing the community-based model of contact investigation included:

- flexible organization of household and home visits;
- opportunity to screen the whole household at the same time;
- opportunity to attend to other health issues at the same time as TB contact investigation;
- possibility of integrated care for contacts and index cases;
- time and financial savings for households.

Challenges to implementing the community-based model of contact investigation included:

- difficulties with accurate weight measurement to determine or adjust TPT dosage (need to carry weighing scales);
- difficulties in reaching households during the rainy season in remote locations;
- risk of delayed TB investigations for referrals, requiring careful recording and follow-up of symptomatic children;
- refusal to participate due to fear of stigma (e.g. index patient not willing to disclose their TB status);
- need for extra human resources and financial support;
- importance of establishing good monitoring and reporting systems.

Source: Community intervention for child contact investigation. CONTACT cluster randomized control study in Uganda and Cameroon within the Unitaid-funded CaP-TB project October 2019–June 2022 (unpublished data).

2.3. TB screening approaches in children and adolescents

Screening serves to identify children and adolescents who may have TB disease (presumptive TB) and who need further evaluation to make or confirm a TB diagnosis (see [Chapter 4](#)). It also helps to identify children and adolescents who are eligible for and could benefit from TPT. A screening test is not intended to be a diagnostic tool. People with positive results on a screening test should undergo further diagnostic evaluation.

Children and adolescents living with HIV should be systematically screened for TB disease at each visit to a health facility. Child and adolescent household contacts of people with TB disease should be systematically screened for TB disease during contact investigation or during follow-up of the index patient's course of treatment.

Among people aged 15 years and over in populations in which TB screening is recommended, systematic screening for TB disease may be conducted using a symptom screen, CXR, molecular WHO-recommended rapid diagnostic tests (mWRDs) or other tests (see [Box 2.7](#)), alone or in combination.

Among people aged under 15 years who are close contacts of a person with TB, systematic screening for TB disease should be conducted using a symptom screen (any one of cough for more than 2 weeks, fever for more than 2 weeks or poor weight gain in past 3 months) or CXR, or both.

Screening children for TB disease is imperative to detect TB earlier, start treatment earlier and increase the likelihood of better treatment outcomes (13, 14). As young children may have EPTB disease with or without pulmonary involvement, HCWs must be aware of symptoms that indicate TB at other sites (e.g. lymphatic, abdominal, meningeal or osteoarticular TB). The symptoms of TB are often underrecognized in children because they are less specific and overlap with those of common childhood diseases, often leading to delayed diagnosis. Certain forms of TB, especially TB of the central nervous system (CNS), carry a high risk of death or permanent disability when detected late, even if they are treated. TBM, disseminated TB and spinal TB are medical emergencies that must be recognized quickly with immediate referral to the appropriate level of care. TB may also present with other features of severity (e.g. severe pneumonia, severe malnutrition or severe anaemia) that require inpatient care.

The risks of severe disease and death from TB can be reduced by BCG vaccination (23, 24). Protection is incomplete, however, and the considerations for screening discussed in this section apply regardless of BCG immunization status. Children who should be targeted for screening are those at particularly high risk of TB disease, especially those in close contact with a person with TB, and children aged 0–9 years living with HIV. For adolescents aged 10–19 years living with HIV, a wider range of tools and tests are available for screening (see [Box 2.7](#)).

Box 2.7 WHO recommendations on TB screening that apply to children and adolescents

The WHO TB screening guidelines use an age cut-off of 15 years for most recommendations applicable to children (14).

Screening for TB in targeted populations

People living with HIV should be systematically screened for TB disease at each visit to a health facility (*strong recommendation, very low certainty of evidence*).

Household contacts and other close contacts of individuals with TB disease should be systematically screened for TB disease (*strong recommendation, moderate certainty of evidence*).

Systematic screening for TB disease may be conducted among subpopulations with structural risk factors for TB. These include urban poor communities, homeless communities, communities in remote or isolated areas, indigenous populations, migrants, refugees, internally displaced persons and other vulnerable or marginalized groups with limited access to health care (*existing recommendation: conditional recommendation, very low certainty of evidence*).

Tools for screening for TB

Among individuals aged 15 years and older in populations in which TB screening is recommended, systematic screening for TB disease may be conducted using a symptom screen, chest X-ray or molecular WHO-recommended rapid diagnostic tests, alone or in combination (*conditional recommendation, very low certainty of evidence for test accuracy*).

Among individuals aged 15 years and older in populations in which TB screening is recommended, computer-aided detection software programmes may be used in place of human readers for interpreting digital chest X-rays for screening and triage for TB disease (*conditional recommendation, low certainty of evidence*).

Among adults and adolescents living with HIV, systematic screening for TB disease should be conducted using the WHO-recommended four-symptom screen, and those who report any one of the symptoms of current cough, fever, weight loss or night sweats may have TB and should be evaluated for TB and other diseases (*strong recommendation, moderate certainty of evidence*).

Among adults and adolescents living with HIV, C-reactive protein using a cut-off of >5 mg/L may be used to screen for TB disease (*conditional recommendation, low certainty of evidence for test accuracy*).

Among adults and adolescents living with HIV, chest X-ray may be used to screen for TB disease (*conditional recommendation, moderate certainty of evidence for test accuracy*).

Among adults and adolescents living with HIV, molecular WHO-recommended rapid diagnostic tests may be used to screen for TB disease (*conditional recommendation, moderate certainty of evidence for test accuracy*).

Adult and adolescent inpatients with HIV in medical wards where the TB prevalence is over 10% should be tested systematically for TB disease with a molecular WHO-recommended rapid diagnostic test (*strong recommendation, moderate certainty of evidence for test accuracy*).

Among individuals younger than 15 years who are close contacts of someone with TB, systematic screening for TB disease should be conducted using a symptom screen including any one of cough, fever or poor weight gain, or chest X-ray; or both (*strong recommendation, moderate to low certainty of evidence for test accuracy*).

Among children younger than 10 years living with HIV, systematic screening for TB disease should be conducted using a symptom screen including any one of current cough, fever, poor weight gain or close contact with a TB patient (*strong recommendation, low certainty of evidence for test accuracy*).

Source: WHO operational handbook on tuberculosis. Module 2: screening – systematic screening for tuberculosis disease. Geneva: World Health Organization; 2021 (<http://apps.who.int/iris/handle/10665/340256>).

Countries are encouraged to monitor and evaluate the yield of TB screening approaches among children and adolescents to be screened, including child close or household contacts and children living with HIV, disaggregated by screening tools and algorithms, to broaden the evidence base on the yield, costs, safety and clinical outcomes of different screening strategies.

2.3.1. Screening child contacts of people with bacteriologically confirmed TB

2.3.1.1. Symptom screening

Any child aged under 10 years who has had close contact with a person with TB disease should be screened for TB with a symptom screen or CXR as part of contact investigation. Symptoms used to screen for TB are cough for more than 2 weeks, fever for more than 2 weeks, and poor weight gain or weight loss in the past 3 months. In young children, reduced playfulness or lethargy should also be included, since prolonged cough may be absent in children with disseminated disease.

Screening is carried out using all questions as part of a symptom screen. If any one or more of the symptoms is present, the child is regarded as having a positive screen and should be managed as having presumptive TB (Figure 2.3). It is useful to examine growth charts regularly to determine whether a child has been losing weight or their weight has plateaued. Weight loss or a plateau in weight gain (failure to thrive) should be a warning sign for possible TB.

Figure 2.3. Algorithm for TB screening in children with symptoms

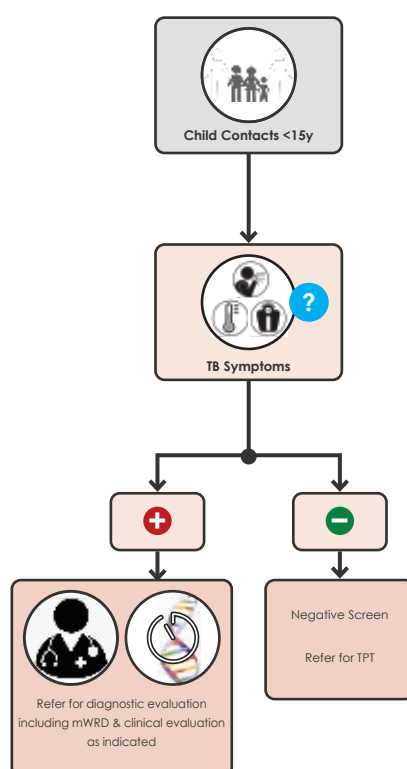

In a systematic review on screening tests for PTB disease in children, a symptom screen in which a child has any of the symptoms of cough, fever or poor weight gain had a sensitivity of 89% and a specificity of 69% for TB disease (against a composite reference standard) (25).

The low specificity of a symptom screen alone means that about 30% of children may undergo unnecessary diagnostic tests or even treatment for TB. The risk of a false-positive diagnosis of TB after a false-positive symptom screen may be higher among children than adults because such a diagnosis is frequently made solely on clinical grounds. Because of the high rates of mortality and morbidity among children with TB and the fact that TB treatment is generally very well tolerated, the risk of a missed diagnosis is generally judged to outweigh the risk of a false diagnosis and unnecessary TB treatment, especially because children generally tolerate TB treatment and TPT well (see [Chapter 4](#)). HCWs should nonetheless remain vigilant to possible false-positive TB diagnoses among children, monitor responses to treatment carefully, and consider alternative diagnoses, especially if a child is not improving on treatment. If a plausible alternative diagnosis is confirmed, providers may consider stopping TB treatment while remaining mindful that TB may coexist with other diseases. TB treatment should never be used as a “trial of treatment” (see [Chapter 5](#)).

2.3.1.2. Chest X-ray

Sensitivity for TB of “any abnormality” as reported on CXR in close contacts aged under 15 years is 84%, and specificity is 91% (25). It is thus more specific than symptom screening alone. Estimates of the accuracy of CXR are not disaggregated by age group, and significant differences in CXR findings between younger and older children may lead to important differences in sensitivity and specificity by age group.

Abnormalities caused by TB seen on CXR in children may differ widely from those in adults. Older children may have adult-type disease presentation, such as lung cavities, but changes on CXR associated with TB disease in younger children may be subtle and hard to see if the quality is not optimal. When using CXR for TB screening in children, ideally both posteroanterior and lateral views

should be done. Common abnormalities in children include enlarged hilar and paratracheal lymph nodes, sometimes with evidence of lymph nodes compressing the airways, alveolar consolidation without visible cavities, miliary lesions (as a sign of disseminated disease) and pleural effusions. It may be difficult to distinguish abnormally enlarged paratracheal and hilar lymph nodes from normal vascular structures. These subtle findings on CXR in younger children may affect the sensitivity and specificity of CXR. The assistance of a practitioner experienced in interpreting paediatric CXR may be sought to resolve questions about interpretation. Computer-aided detection software for interpreting CXR for TB is recommended by WHO as an alternative to human reading (see Chapter 4 in the *WHO operational handbook on tuberculosis. Module 2: screening – systematic screening for tuberculosis disease (13)*). This recommendation is currently limited to people aged 15 years and older, and more data should be collected to validate the performance of computer-aided detection software for TB in children.

CXR can be used in combination with symptom screening to screen for TB disease. CXR is not readily available in many locations, and travel to another location for CXR may not be feasible for caregivers, who may be unable to make time or to afford direct or indirect costs for travel, time, support or radiography services. Mobile CXR units may be used to reach populations with poor access, but these require training and financial and logistical support.

Newer digital X-ray machines emit a small amount of radiation, but the radiation risk to the patient is very low. Chapter 3 in the *WHO operational handbook on tuberculosis. Module 2: screening – systematic screening for tuberculosis disease (13)* outlines additional considerations for implementing CXR, including the benefits and drawbacks of serial and parallel screening when combined with symptom screening.

Figures 2.4–2.7 provide algorithms for TB screening in children and young adolescents, using CXR, symptoms and CXR, sequential positive and negative serial TB screening with symptoms and chest X-ray, respectively.

Figure 2.4. Algorithm for TB screening of children with chest-X-ray

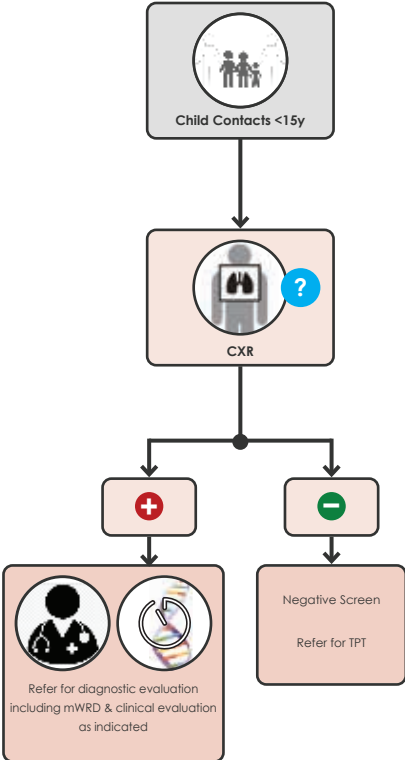

Figure 2.5. Algorithm for parallel TB screening of children with symptoms and chest X-ray

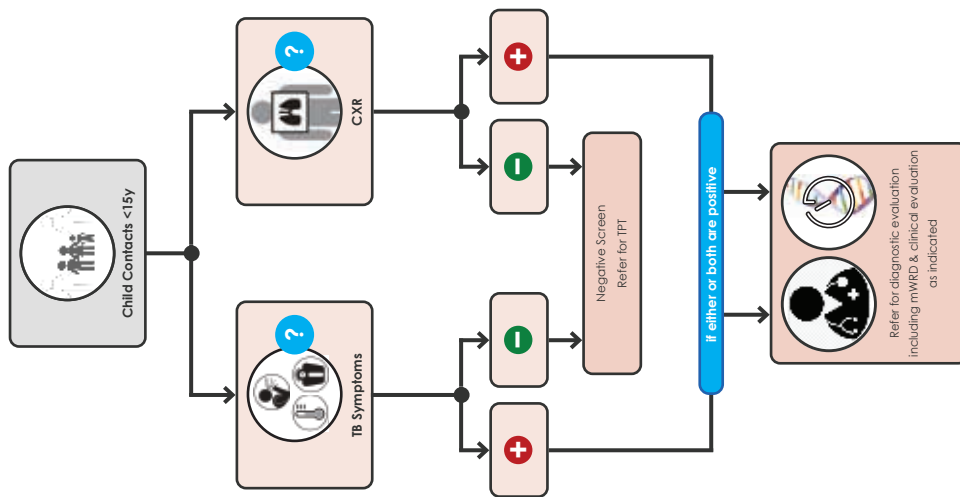

Figure 2.6. Algorithm for sequential positive serial TB screening in children with symptoms and chest X-ray

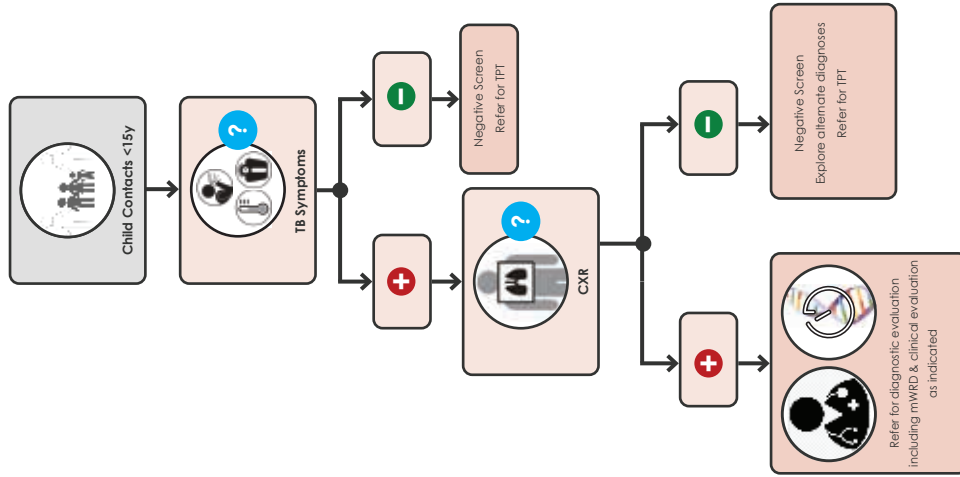
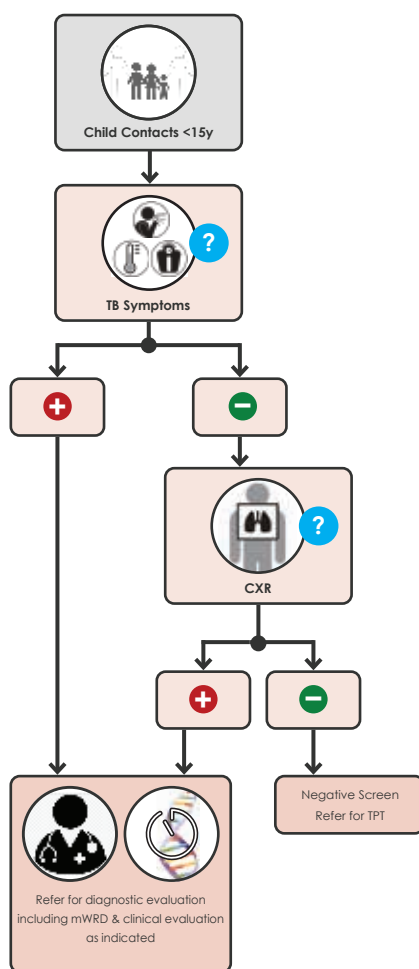

Figure 2.7. Algorithm for sequential negative serial TB screening in children with symptoms and chest X-ray



2.3.1.3. Molecular WHO-recommended rapid diagnostic tests

mWRDs are not currently recommended for screening for TB disease in children and young adolescents aged under 15 years, but they should be used to diagnose TB in children who screen positive using a symptom screen or CXR (see [Chapter 4](#)).

2.3.1.4. Tests for TB infection

As in adults, TST and IGRA should not be used to screen for TB disease in children (26, 27), as these tests cannot distinguish TB infection from TB disease and cannot predict who will progress to TB disease. Both tests provide a marker of TB infection but may be influenced by mechanisms unrelated to TB infection and give false-negative or false-positive results. The role of these tests in decision-making for TPT and in the diagnostic evaluation of children with presumptive TB is discussed in [Chapters 3 and 4](#) (15, 28).

2.3.2. Considerations for implementation of screening of child close contacts

Once the contacts of a person with TB have been identified, the contacts should be screened for TB symptoms and/or undergo CXR, followed by appropriate diagnostic evaluation (15, 28). Contact

investigation can be expensive and time-consuming for HCWs. Additionally, TB is a highly stigmatized disease in some settings, and the visit of a health worker to a person’s home may risk discrimination against the household. HCWs can ask people with TB to bring their contacts, including children, to a health facility for TB screening; however, parents and caregivers may not be able to take children for evaluation, for a variety of reasons, including financial and time constraints, lack of appreciation of the importance of screening, and distrust of health care services (4). These issues should be considered carefully when determining the best local approach. Health care providers, health care managers and health programmes should consider the preferences and concerns of parents and caregivers when deciding how to implement screening.

Children and adolescents exposed to a person with TB but found not to have TB disease should be assessed for TB infection and eligibility for TPT as per national guidelines and aligned to WHO recommendations (15, 28). Asymptomatic close contacts aged 5 years and over should undergo CXR if available, and must complete a detailed evaluation for TB if CXR is abnormal. CXR is not a requirement before starting TPT in asymptomatic close contacts aged under 5 years. If CXR is not available, a child can be started on TPT if TB disease is ruled out based on a negative symptom screen.

2.4. Screening children and adolescents living with HIV

Children living with HIV have a high risk of rapid progression to severe disease and death if a diagnosis of TB is missed. A child living with HIV is 3.5 times more likely to progress to TB disease than a child who is HIV-negative (29). The risk, although greatly reduced, remains elevated in children on antiretroviral therapy (ART). An estimated 10% of paediatric deaths from TB are among children living with HIV, with 21 000 deaths annually (7). It is for this reason that WHO strongly recommends that children living with HIV are screened for TB.

2.4.1. Screening for symptoms and contact

Figure 2.8. Algorithm for TB screening of children living with HIV with symptoms

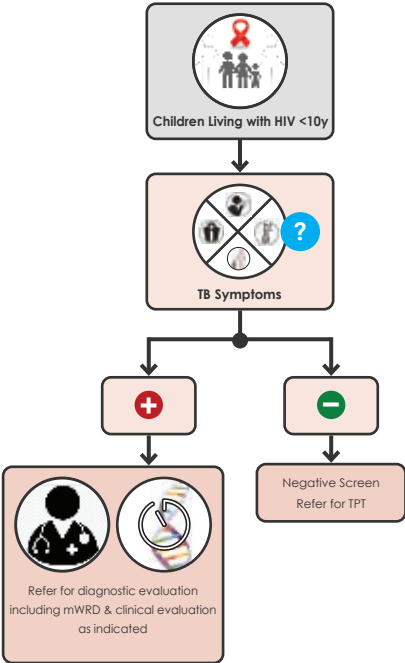

Children living with HIV aged under 10 years should be screened for TB at every encounter with a HCW for current cough, fever, poor weight gain or close contact with a person with TB (see [Figure 2.8](#)). The systematic review conducted for the 2021 WHO screening guidelines showed that presence of any one of these conditions has a sensitivity of 61% and a specificity of 94%. Children who are positive on this screen should undergo further diagnostic evaluation for TB disease (25). Adolescents aged 10–19 years should be screened in the same way as adults.

Screening for TB can be difficult in a child living with HIV. Even older children, who may otherwise be expected to have more typical adult-type TB disease if they are living with HIV, frequently have extrapulmonary disease and atypical symptoms (30). HCWs should maintain a strong clinical suspicion of TB in any child living with HIV, even in the absence of classic symptoms of TB, especially in high TB burden areas.

2.4.2. Other screening tests

There are currently inadequate data to extrapolate use of CXR, point-of-care C-reactive protein (CRP)-based TB screening or mWRDs as screening tests in adults to children aged under 10 years living with HIV. CXR can be used for screening children living with HIV who are close contacts of people with infectious TB (see [Section 2.3.1](#)). Tests for TB infection such as IGRA are not useful for TB screening.

2.4.3. Considerations for implementation

Children living with HIV should be followed up closely in the health care system. Those living in high TB incidence settings should be screened for TB at every contact with the health care system. Given the high risk of progression to TB disease and the high mortality rate, combined symptom screening should also be done at every contact with the health care system, including events such as vaccination days, maternal health appointments, nutritional screening and food support programme visits. The combined symptom screen has low specificity, which may lead to a large number of false-positive screens and further diagnostic testing. Nevertheless, given the high mortality due to untreated TB among children living with HIV, the risk of over-investigation and treatment is generally outweighed by the benefits of TB treatment. HCWs should closely monitor TPT or TB treatment and remain vigilant to the possibility of alternative diagnoses.

It may be difficult to determine whether a child has had close contact with a person with TB. It is important to take a careful history of the known exposures of the parent or caregiver and child. Household contacts are often considered, but, particularly in areas with a high TB incidence, close contact can occur in a variety of community settings, including school, daycare and religious settings. A study in South Africa indicated that only half of children with TB had a known household contact with a person with TB, and even young children had a high risk of being infected in the community outside the household (30). A high index of suspicion of TB in young children should be maintained, especially for children living with HIV or of unknown HIV status in settings with a high TB incidence. Children living with HIV who are found not to have TB disease should receive TPT as per WHO guidelines (75, 28).

2.4.4. Screening of adolescents living with HIV

As highlighted in [Box 2.7](#), systematic screening for TB disease should be conducted among adolescents living with HIV using the WHO-recommended four-symptom screen (W4SS). Those who report any one of the symptoms of current cough, fever, weight loss or night sweats may have TB and should be evaluated for TB and other diseases. Adolescents living with HIV may also be screened using CRP (using a cut-off of >5 mg/L), CXR or mWRDs. Similar to adults, adolescents living with HIV who are inpatients in medical wards where TB prevalence is high (over 10%) should be tested systematically for TB disease with mWRDs (73). See [Section 7.1](#) for more information on TB/HIV coinfection.

Key messages

- After exposure to a person with infectious TB, children and adolescents have a high risk of developing TB disease.
- Contact investigation is important to identify children who have been exposed to TB and to screen them for TB disease:
 - Contact investigation needs dedicated human and financial resources.
 - Contact investigation is most efficient if conducted in an active manner at the community or household level.
- Screening approaches differ slightly for children who are close contacts of a person with TB and children living with HIV:
 - For close contacts of a person with TB:
 - screening tools – symptom screen and/or CXR;
 - symptom screen – cough for more than 2 weeks, fever for more than 2 weeks and poor weight gain (or weight loss) in the past 3 months;
 - timing of screening – during contact investigation and follow-up activities.
 - For children living with HIV:
 - screening tool – symptom screen;
 - symptom screen – current cough, fever, poor weight gain in the past 3 months, or close contact with a person who has TB;
 - timing of screening – every encounter with a HCW.
- Tools for screening for children include symptom screening (which can be used in all settings, including during contact investigation in households and communities) and CXR (at health care facilities or using mobile X-ray facilities).
- Children who screen positive on a TB symptom screen (e.g. any one of cough for more than 2 weeks, fever for more than 2 weeks or poor weight gain in the past 3 months) and/or have an abnormal CXR should be identified as having presumptive TB and evaluated for TB disease.
- Children who do not have TB symptoms (and a normal CXR, if available) on TB screening should be offered TPT if they do not have contraindications.
- Screening activities should be monitored and evaluated.
- See [Chapter 6](#) for more details on integration of screening approaches in various child health entry points.

3. Prevention of TB in children and adolescents

3.1. Introduction

This chapter describes strategies for the prevention of TB in children and adolescents. It covers BCG vaccination, TPT and TB infection prevention and control. This chapter relates to the section of the pathway highlighted in blue in Figure 3.1.

Figure 3.1. Pathway through exposure, infection and disease covered in Chapter 3

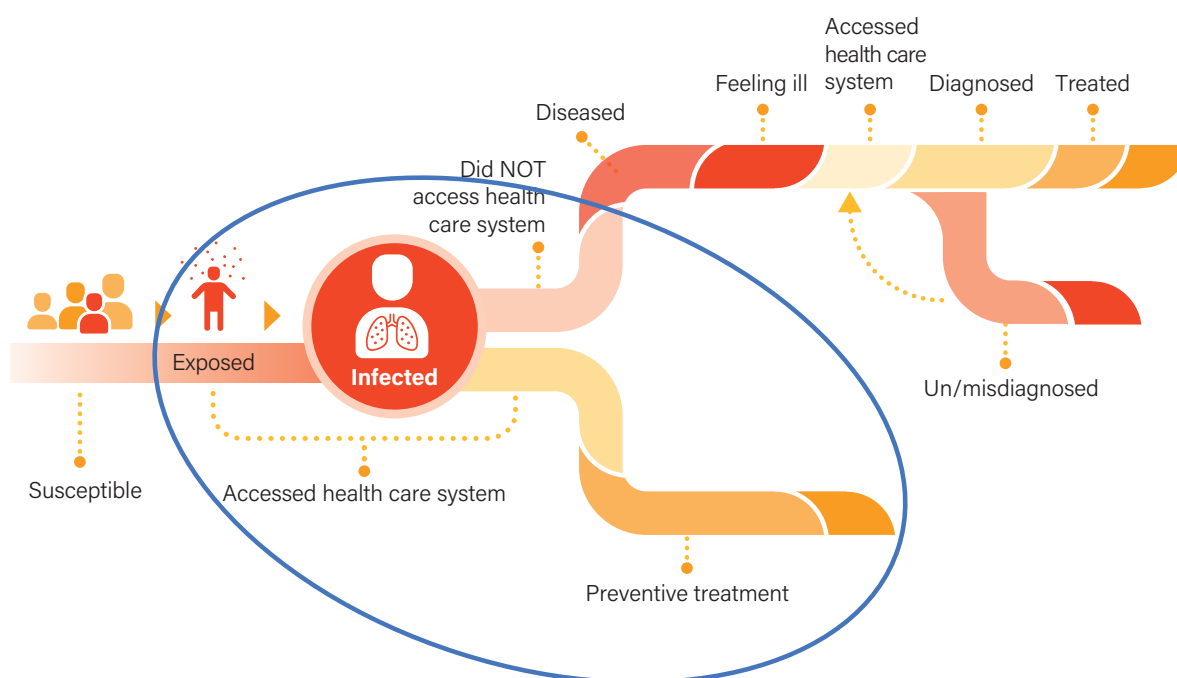

Source: Roadmap towards ending TB in children and adolescents. Geneva: World Health Organization; 2018 (<https://apps.who.int/iris/handle/10665/275422>).

3.2. BCG vaccination

BCG is a live attenuated bacterial vaccine derived from *Mycobacterium bovis* that was originally isolated in 1902 from a tuberculous cow. BCG has demonstrated significant effectiveness, but protection has not been consistent against all forms of TB in all age groups. BCG has also shown effectiveness in preventing leprosy (caused by *Mycobacterium leprae*) and Buruli ulcer (caused by *Mycobacterium ulcerans*) (31).

BCG provides good (up to 90%) protection against severe forms of TB, including TBM and miliary TB, if given during the neonatal period. Although neonatal vaccination also provides protection against

PTB in children, it mainly prevents progression to disseminated forms of TB. A systematic review found that BCG-vaccinated children exposed to people with infectious TB had 19% less TB infection than unvaccinated children (95% confidence interval (CI) 8–29%), suggesting that BCG has a modest protective effect against *M. tuberculosis* infection. BCG may also have nonspecific beneficial effects on all-cause mortality (31). A randomized controlled trial comparing BCG at birth versus age 6 weeks found that vaccination was protective against non-tuberculous infectious disease during the neonatal period, in addition to having TB-specific effects (32).

BCG vaccination is recommended in countries or settings with a high incidence of TB¹³ or leprosy and areas where Buruli ulcer occurs. A single dose should be given to all healthy neonates at birth. If BCG vaccine cannot be given at birth, it should be administered as soon as possible thereafter. Countries with a low incidence of TB or leprosy may choose to selectively vaccinate high-risk neonates. In countries where TB incidence rates are steadily declining, the epidemiology of TB should be evaluated, and switching to vaccination of people in selected risk groups may be considered (31).

High-risk neonates in low TB incidence countries include those:

- living in a household with a person from a high TB incidence country;
- going to visit or live in a high TB incidence country;
- with current close contact with a person known to have TB.

Studies have not consistently shown additional benefit of repeat BCG vaccination against the development of TB or leprosy. Revaccination is not recommended even if TST or IGRA is negative. The only older age groups for whom BCG vaccination is currently recommended are unvaccinated TST-negative or IGRA-negative schoolchildren coming from or moving to high TB incidence or high TB burden settings, and other TST-negative or IGRA-negative people at risk through occupational exposure, such as HCWs working in high TB incidence settings (31).

3.2.1. Recommendations from the WHO BCG position paper

3.2.1.1. Children living with HIV and neonates

BCG in children living with HIV

Children known to be living with HIV should not receive BCG vaccination because they are at increased risk of developing disseminated BCG disease. However, if they are receiving ART, are clinically well and immunologically stable they should be vaccinated. Immunologically stable children have a CD4% over 25% (children aged under 5 years) or a CD4 count of 200/mm³ or higher (children aged over 5 years). In settings without access to CD4 testing, immunological stability may be assessed clinically, based on the absence of new opportunistic infections and any other symptoms. If viral load testing is available, an undetectable viral load in combination with the child being clinically well without new opportunistic infections satisfies this requirement (31).

BCG in neonates

Neonates born to women with unknown HIV status should receive BCG vaccination. Neonates with unknown HIV status born to women living with HIV should be vaccinated, provided they have no clinical evidence suggestive of HIV infection, irrespective of the mother's ART status. All mothers living with HIV should be offered treatment to reduce the risk of vertical HIV transmission.

¹³ More than 100 TB cases per 100 000 population.

Neonates diagnosed with HIV infection, as confirmed by early virological testing, should not receive BCG at birth. Vaccination should be delayed until ART has been started and the infant is confirmed to be immunologically stable (CD4% over 25% in children aged under 5 years; CD4 count of 200/mm³ or higher in children aged over 5 years).

Neonates born to women with bacteriologically confirmed PTB who do not have TB symptoms should receive TPT after exclusion of TB disease. The infant should be regularly followed up and monitored for the development of symptoms and signs suggestive of TB. If the infant remains asymptomatic and is HIV-negative, BCG vaccination should be provided using a normal infant dose 2 weeks after completion of the full course of TPT (31). See Section 7.2 on management of neonates exposed to mothers with infectious TB.

3.2.1.2. Administering BCG

Training of health care providers to administer BCG vaccination is important to ensure the correct technique is used. The standard dose of BCG vaccine is an intradermal injection of 0.05 mL of the reconstituted vaccine for infants aged under 1 year, and 0.1 mL for infants aged over 1 year. BCG vaccine can safely be given together with other routine childhood vaccines, including the hepatitis B birth dose. Although efforts should be made to use all doses in BCG multidose vials, children should be vaccinated even if this means part of the vial is wasted. Appropriate infection control techniques should be in place for multidose vials.

Figure 3.2. Injection techniques

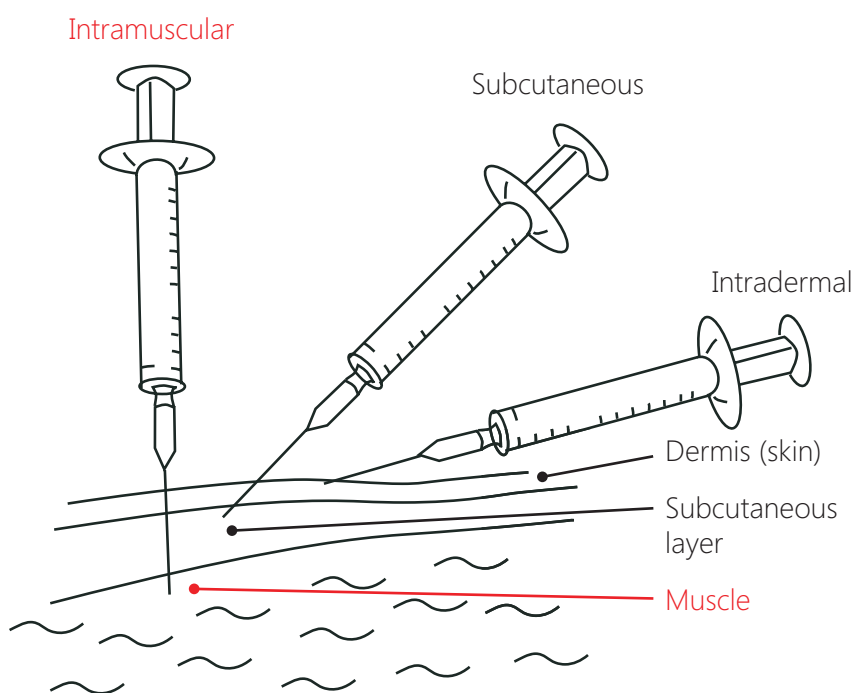

Source: Vaccine safety basics. Geneva: World Health Organization (e-<https://vaccine-safety-training.org/route-of-administration.html>).

Intradermal injection administers the vaccine in the topmost layer of the skin (Figures 3.2 and 3.3). BCG is the only vaccine with this route of administration. It has been reported to be the most difficult vaccine to administer due to the small size of newborn arms and the technical nature of intradermal injection.

Figure 3.3. Administering BCG injection



Source: <https://i.ytimg.com/vi/F2cvT7zbLLw/maxresdefault.jpg>.

To administer the BCG vaccine:

- a short narrow needle (15 mm, 26 gauge) is used;
- the needle should be introduced just under the skin over the left deltoid area;
- the syringe should be held at a 5- to 15-degree angle from the site;
- the needle should be placed almost flat against the patient's skin, bevel side up;
- the needle should be partially inserted into the skin until the entire bevel is covered by skin;
- when injecting the solution, there should be some resistance and a small weal or bleb should appear, indicating the fluid is in the dermis.

3.2.1.3. Contraindications for BCG

Despite its safety, BCG is an attenuated live vaccine (*M. bovis* BCG). Contraindications include:

- pregnancy;
- people living with HIV but not on ART, or on ART but not immunologically stable;
- people with other forms of immunosuppression (e.g. candidates for organ transplants, people on immunosuppressive therapy).

3.2.1.4. Adverse reactions

BCG vaccine is used extensively worldwide, with about 100 million newborns vaccinated each year. Severe adverse events are reported only occasionally. For some adverse events (e.g. disseminated BCG disease), the diagnosis may depend on the culturing of *M. bovis* BCG to distinguish it from other forms of mycobacterial disease (33). It is important to recognize that *M. bovis* BCG has a positive result when tested with Xpert[®] MTB/RIF (Cepheid, Sunnyvale, United States of America) or Ultra (see Chapter 4). It should be considered as the likely cause of a hilar lymph node mass (which is positive on Xpert) on the same side as the BCG vaccination in a child who has recently received BCG and is otherwise clinically well.

Mild adverse events

After BCG vaccination, almost all children experience an injection site reaction characterized by a papule, which may be red, tender and indurated. The papule commences 2 weeks or more after vaccination and may progress to an ulcer that heals after 2–5 months, leaving a superficial scar. Swelling of the regional lymph nodes on the same site as the injection (usually axillary but also cervical

and/or supraclavicular nodes) may also occur. Affected lymph nodes remain small (under 1.5 cm) and do not adhere to overlying skin. Ulcers should be left to heal on their own and not manipulated.

Mild local reactions may happen despite correct intradermal administration. The extent of the reaction depends on a number of factors, including the strain used in the vaccine, the number of viable bacilli in the batch, and variation in injection technique. No treatment is required for mild injection site reactions with or without mild regional lymphadenopathy. If required, analgesics such as paracetamol can be provided.

Severe adverse events

Severe adverse events can occur after BCG vaccination, but they are rare.

Severe local adverse events include:

- injection site reactions, such as local subcutaneous abscess and keloids (thickened scar tissue);
- skin lesions distinct from the vaccination site – multiple cutaneous lesions may be a sign of disseminated BCG disease in an immunocompromised host;
- BCG lymphadenitis – in severe forms, lymph nodes may become adherent to overlying skin with or without suppuration (fluctuation on palpation or pus on aspiration, a sinus, or a large lymph node adherent to the skin with caseous lesions on excision). This usually affects ipsilateral axillary lymph nodes, but supraclavicular or cervical nodes may also be involved. Lymph node aspirates may be positive on Xpert MTB/RIF or Ultra.

Severe systemic adverse events include systemic or disseminated BCG disease in which *M. bovis* BCG is confirmed in one or more anatomical sites far from the site of injection and regional lymph nodes (34). Disseminated BCG disease or systemic BCG-itis is associated with a case fatality rate of over 70% in infants living with HIV. It may clinically present very similarly to TB and can be confirmed only through positive mycobacterial culture with species identification. Symptoms include wasting or failure to thrive, anaemia, hepatosplenomegaly, lymphadenitis (axillary, cervical), osteomyelitis and CXR infiltrates.

Immune reconstitution inflammatory syndrome (IRIS) is a BCG vaccine-related adverse event seen in immunocompromised people living with HIV who are started on ART. It usually develops within 3 months of immune recovery and presents as local abscesses or regional lymphadenitis, usually without dissemination. Early initiation of ART before immunological and/or clinical HIV progression has been shown to substantially reduce the risk of BCG IRIS regional adenitis.

Other rare events include osteitis, osteomyelitis, sarcoidosis, ocular lesions (conjunctivitis, choroiditis, optic neuritis), erythema nodosum and meningitis (exceptionally rarely).

Management of severe adverse events

In many cases, local and regional adverse events resolve without intervention, but treatment can include oral antibiotics (BCG is resistant to pyrazinamide, and some strains are partially resistant to isoniazid), needle aspiration of fluctuant masses, and surgical removal of affected lymph nodes, along with analgesics such as paracetamol. A systematic review conducted in 2013 found no evidence of any benefit of using oral antibiotics to treat local or regional BCG-induced disease. In people with abscess-forming lymphadenopathy, needle aspiration of abscesses provides pain relief (35).

Children with systemic adverse events require referral to specialized care. There are no clear guidelines on treatment of disseminated BCG disease, but management usually includes isoniazid, rifampicin and ethambutol (with or without a fluoroquinolone such as levofloxacin) (36). Surgical intervention may be needed, depending on localization (37).

Box 3.1 COVID-19 and BCG

In addition to its specific effect against TB, the BCG vaccine has beneficial nonspecific (off-target) effects on the immune system. These are not well understood, but the vaccine may protect against a wide range of other infections, and it is used routinely to treat bladder cancer in adults. This has led to the suggestion that BCG vaccination may have a role in protecting HCWs and other vulnerable people against severe coronavirus disease 2019 (COVID-19), but this has not been confirmed and studies are ongoing (38, 39).

Neonatal BCG vaccination protects infants and young children against severe disseminated forms of TB, including TBM and miliary TB (31). Global BCG supply shortages between 2014 and 2017 highlighted the importance of sustaining neonatal BCG vaccination, especially in settings with high TB and high HIV burdens (40, 41). The risk associated with low vaccination coverage in association with BCG stockouts has been highlighted by the dramatic increase in the incidence of TBM in young children reported in South Africa (42). Manufacturer and supply chain issues have been largely resolved, although BCG supplies remain fragile (43, 44). The main factors affecting the BCG market include limited demand flexibility and supply concentration. Over half of the 125 countries reporting BCG in their routine vaccination schedules have only one product registered and require full registration. As a result, these countries may be at risk of shortages if a production issue occurs to the product of current choice. In addition, only two manufacturers produce around 45% of the global vaccine supply (43).

WHO issued a scientific brief in April 2020 stating that in the absence of evidence, WHO does not recommend BCG vaccination for the prevention of COVID-19 and that WHO continues to recommend neonatal BCG vaccination in countries or settings with a high TB incidence (45).

3.3. TB preventive treatment

3.3.1. Introduction

TB infection (previously called latent TB infection) is defined as a “state of persistent immune response to stimulation by *M. tuberculosis* antigens without evidence of TB disease” (15). The number of people worldwide estimated to have *M. tuberculosis* infection is 1.7 billion. Further, 7.5 million children aged under 15 years are estimated to be infected with TB every year (11). By 2014, a cumulative 67 million children aged under 15 years were infected with TB, including 2 million with MDR-TB and 100 000 with XDR-TB strains (12). People with TB infection have no signs or symptoms of TB disease and are not infectious, although they are at risk of developing TB disease in the future.

On average, 5–10% of people with TB infection develop TB disease over the course of their lives, usually within the first 5 years after initial infection. The risk for TB disease after infection is particularly increased among young children and in people with immunocompromising conditions such as HIV infection, in whom disease progression is also more rapid, usually within 12 months of infection.

Providing treatment for TB infection to prevent TB disease is a critical component of Pillar 1 of the WHO End TB Strategy (7). The efficacy of currently available TPT regimens ranges from 60% to 90% (28). The potential benefit of TPT needs to be balanced against the risk for drug-related adverse events. For people with TB infection in population groups with a high risk for progression to TB disease, the benefits of TPT are greater than the potential harms. Provision of TPT involves a comprehensive package of interventions: identification and testing in populations with high TB risk (including contacts of people with TB), delivering effective and safe preventive treatment, and monitoring and evaluation of the cascade of care (15).

3.3.2. Target groups for TB preventive treatment

The WHO consolidated guidelines on tuberculosis (28) and the WHO operational handbook on tuberculosis (15) identify two broad at-risk child and adolescent populations that need systematic assessment for eligibility for TPT:

- children and adolescents with elevated risk of progression from TB infection to TB disease, including children and adolescents living with HIV and adolescents with specific comorbidities or on specific treatment (e.g. anti-tumour necrosis factor treatment, dialysis, preparing for organ or haematological transplantation);
- children and adolescents with increased likelihood of exposure to TB, including household contacts of people with bacteriologically confirmed TB and those living or working in institutional or crowded settings (e.g. recent immigrants from high TB burden countries, homeless people, people who use drugs).

Box 3.2 WHO recommendations on target groups for TB preventive treatment

The following target groups should be considered for TPT among children and adolescents (28):

→ Infants, children and adolescents living with HIV:

- Adults and adolescents living with HIV who are unlikely to have TB disease should receive TPT as part of a comprehensive package of HIV care. Treatment should also be given to people on ART, pregnant women and people who have previously been treated for TB, irrespective of the degree of immunosuppression and even if TB infection testing is unavailable (*strong recommendation, high certainty in the estimates of effect*).
- Infants aged under 12 months living with HIV who are in contact with a person with TB and who are unlikely to have TB disease on an appropriate clinical evaluation or according to national guidelines should receive TPT (*strong recommendation, moderate certainty in the estimates of effect*).
- Children aged 12 months and over living with HIV who are considered unlikely to have TB disease on an appropriate clinical evaluation or according to national guidelines should be offered TPT as part of a comprehensive package of HIV prevention and care if they live in a setting with high TB transmission, regardless of contact with TB (*strong recommendation, low certainty in the estimates of effect*).
- All children living with HIV who have successfully completed treatment for TB disease may receive TPT (*conditional recommendation, low certainty in the estimates of effect*).

→ Household contacts (regardless of HIV status):

- Children aged under 5 years who are household contacts of people with bacteriologically confirmed PTB and who are found not to have TB disease on an appropriate clinical evaluation or according to national guidelines should be given TPT, even if TB infection testing is unavailable (*strong recommendation, high certainty in the estimates of effect*).
- Children aged 5 years and over and adolescents who are household contacts of people with bacteriologically confirmed PTB who are found not to have TB disease by an appropriate clinical evaluation or according to national guidelines may be given TPT (*conditional recommendation, low certainty in the estimates of effect*).
- In selected high-risk household contacts of people with MDR-TB, TPT may be considered based on individualized risk assessment and a sound clinical justification (*conditional recommendation, very low certainty in the estimates of effect*).

→ Other children and adolescents at risk:

- People (including children and adolescents) initiating anti-tumour necrosis factor treatment, receiving dialysis, preparing for an organ or haematological transplant or with silicosis should be systematically tested and treated for TB infection (*strong recommendation, low to very low certainty in the estimates of effect*).
- Systematic TB infection testing and treatment may be considered for (child or adolescent) prisoners, (child or adolescent) immigrants from high TB burden countries, homeless people (including children and adolescents), and people who use drugs (*conditional recommendation, low to very low certainty in the estimates of effect*).

3.3.2.1. Children and adolescents living with HIV

Children and adolescents living with HIV are 8–20 times more likely to develop TB disease than those without HIV infection and should be prioritized for systematic evaluation and TPT in all settings (15, 46). Despite major progress in access to and effectiveness of ART, TB is the most frequent cause of acquired immunodeficiency syndrome (AIDS)-related deaths worldwide (47). It was estimated that in 2020, TB caused over 21 000 deaths among children and adolescents aged under 15 years living with HIV, and about 10% of all HIV-related TB deaths in this group (7). Evidence shows that TPT increases the survival of people living with HIV even when they are on ART (48). TPT also provides additional protection when given immediately after the successful completion of treatment for TB disease among people living with HIV (48–50). Box 3.2 presents relevant recommendations from the 2020 WHO guideline on TPT (28).

TPT should be considered in infants aged under 12 months living with HIV who have a history of close contact with a person with infectious TB. Children living with HIV aged 12 months and over should be considered for TPT, irrespective of contact with a person with TB. TPT is recommended for children living with HIV, regardless of whether they are on ART or not. The evidence for additive benefit of TPT among children living with HIV on ART is limited, but it is plausible given the efficacy observed among adults with HIV receiving ART plus TPT. Similarly, the effect of TPT in children living with HIV after successful completion of TB treatment is largely extrapolated from benefits observed in adults exposed to reinfection and recurrence of TB.

Similar to infants aged under 12 months who are living with HIV, infants born to women living with HIV are vulnerable to early TB infection due to the mother's risk of contracting TB disease (51, 52). Given the poor outcomes of TB disease in infancy, it is important to consider TPT for such infants who show no signs of TB disease. Programmes for prevention of mother-to-child transmission of HIV offer an important platform to screen infants exposed to HIV for TB disease and provide TPT for those without TB disease. A strong linkage should therefore be established between mother-to-child prevention services and NTPs (53).

WHO recommends provision of TPT among children living with HIV who have successfully completed treatment for TB disease. People living with HIV face higher risk of recurrence of TB disease compared with HIV-negative people. A complete course of TB treatment with a four-medicine regimen is shown to have a very high treatment success rate and very low incidence (2–3%) of recurrence. In people living with HIV, the risk is several times higher, possibly due to treatment failure, emergence of drug resistance during treatment, or reinfection with a new strain of *M. tuberculosis* (54–57). In a study among people living with HIV whose initial episode of TB was deemed cured, 14% experienced a recurrence of TB, of which close to 90% were due to reinfection with a different strain of *M. tuberculosis* (58). Key interventions to minimize recurrence of TB include ensuring completion of the initial course of TB treatment, effective infection control measures in clinical and community settings frequented by people living with HIV, and TPT after completion of a course of TB treatment (59, 60).

3.3.2.2. Child and adolescent household contacts

Children aged under 5 years who are household contacts of people with bacteriologically confirmed TB have a significantly higher risk of acquiring TB infection and progressing rapidly to TB disease. Children aged under 2 years are also at particularly high risk for severe and disseminated forms of TB with very high risk of morbidity and mortality. TPT is strongly recommended in all TB household contacts aged under 5 years once TB disease is ruled out. Other household contacts are also at increased risk of acquiring TB infection compared with the general population and should be considered for the programmatic management of TPT.

WHO recommends consideration of TPT for selected household contacts of people with MDR-TB, including children, people receiving immunosuppressive therapy and people living with HIV, because the evidence shows more benefits than harm (28). The decision to treat MDR-TB contacts should be taken on an individual basis, with respect to the selection of the person to treat and the TPT regimen. WHO does not currently recommend a specific preventive treatment regimen for contacts of MDR-TB due to limited evidence. Studies that informed this recommendation, however, used levofloxacin with or without ethambutol or ethionamide daily for 6 months. TPT should be considered only after TB disease has been ruled out by a clinical evaluation or according to national guidelines and after a careful risk assessment, including intensity of exposure, certainty of the source of disease, reliable information on the drug resistance pattern of the source case, and potential adverse drug reactions.

Confirmation of TB infection by TST or IGRA is desirable before the start of TPT. This maximizes the likelihood of TPT not being given unnecessarily to prevent MDR-TB. There is less evidence on the balance of benefits and harms for the medicines used to prevent MDR-TB than for drug-susceptible TB, and therefore the decision to provide TPT needs to carefully consider any potential risks. If a fluoroquinolone is used for prevention of MDR-TB, it is important to exclude TB disease to limit the risk of emergence of resistance to this class of medicines (e.g. levofloxacin is a key medicine in second-line treatment regimens; moxifloxacin is recommended for the treatment of drug-susceptible TB as a component of the 4-month regimen in adolescents and adults aged 12 years and over) if the person requires treatment for TB or MDR-TB disease in the future. Strict clinical observation for signs of TB disease for at least 2 years after exposure should be ensured, regardless of whether TPT for MDR-TB is given or not.

Implementation considerations on reaching household contacts are described in [Chapter 2](#).

3.3.3. Ruling out TB disease before starting TB preventive treatment

It is important to exclude TB disease before initiating TPT. A clinical algorithm based on screening for symptoms of TB, history of contact with a person with TB, HIV status, age, TB infection test results and abnormal findings on CXR is recommended (15). Figure 3.4 shows an algorithm applicable to children aged under 5 years with and without HIV, and children and adolescents aged 5 years and over.

Box 3.3 WHO recommendations on ruling out TB disease before starting TB preventive treatment

Adults and adolescents living with HIV should be screened for TB according to a clinical algorithm. Those who do not report any of the symptoms of current cough, fever, weight loss or night sweats are unlikely to have TB disease and should be offered preventive treatment, regardless of their antiretroviral therapy status (14) (*strong recommendation, moderate certainty in the estimates of effect*).

Adults and adolescents living with HIV who are screened for TB according to a clinical algorithm and who report any of the symptoms of current cough, fever, weight loss or night sweats may have TB disease and should be evaluated for TB and other diseases and offered preventive treatment if TB disease is excluded (*strong recommendation, moderate certainty in the estimates of effect*).

Chest X-ray may be offered to people living with HIV and on antiretroviral therapy and preventive treatment given to those with no abnormal radiographic findings (*conditional recommendation, low certainty in the estimates of effect*).

Infants and children living with HIV who have poor weight gain, fever or current cough or who have a history of contact with a person with TB should be evaluated for TB disease and other diseases that cause such symptoms. If TB disease is excluded after an appropriate clinical evaluation or according to national guidelines, these children should be offered preventive treatment, regardless of their age (*strong recommendation, low certainty in the estimates of effect*).

The absence of any symptoms of TB and the absence of abnormal CXR findings may be used to rule out TB disease among HIV-negative household contacts aged 5 years and over and other at-risk groups before preventive treatment (*conditional recommendation, very low certainty in the estimates of effect*).

Source: WHO consolidated guidelines on tuberculosis. Module 1: prevention – tuberculosis preventive treatment. Geneva: World Health Organization; 2020 (<https://apps.who.int/iris/handle/10665/331170>) (28).

3.3.3.1. HIV-negative household and close contacts of a person with pulmonary TB: infants and children aged under 5 years

Children aged under 5 years who are household contacts of a person with bacteriologically confirmed PTB are usually identified through contact investigation or visits to health care facilities. They should be screened for TB symptoms (current cough, fever, not eating well or anorexia, weight loss or failure to thrive, fatigue, reduced playfulness, decreased activity). Those with any one of the symptoms should be evaluated for TB disease, while those who are asymptomatic should be offered TPT. For asymptomatic household contacts aged under 5 years, testing for TB infection by TST or IGRA or CXR is not required before initiating TPT.

3.3.3.2. HIV-negative household and close contacts of a person with pulmonary TB: children and adolescents aged 5 years and over

Target groups for TPT were expanded from the 2018 WHO updated and consolidated guidelines for programmatic management (61) and later versions to include HIV-negative household contacts aged 5 years and over. In this target group, confirmation of TB infection using TST or IGRA, absence of any symptoms of TB, and absence of abnormal findings on CXR may be used to rule out TB disease before starting TPT (28).

3.3.3.3. Children and adolescents living with HIV

Children and adolescents living with HIV should be screened for TB disease at every visit to a health facility or interaction with a health worker, using standard screening questions, as part of routine clinical care (see [Chapter 2](#)). Those who do not have any of the symptoms in the questionnaire are unlikely to have TB disease and should be offered TPT, regardless of their ART status. CXR may be offered to adolescents living with HIV and on ART; if there are no abnormal radiographic findings, they may be given TPT. Lack of availability of CXR should not pose a barrier to providing TPT to adolescents living with HIV.

TB infection testing is not a requirement for initiating TPT but may be used where available to determine TPT eligibility in adolescents living with HIV. Infants aged under 12 months who are living with HIV and who do not have TB symptoms should be given TPT only if they have a history of contact with a person with TB, and TB disease has been excluded. Infants, children and adolescents living with HIV who report any of the symptoms listed may have TB disease and should be evaluated for TB and other diseases (see [Chapter 4](#)). If TB disease is excluded after an appropriate clinical evaluation or according to national guidelines, TPT should be offered.

The treatment decision algorithms described in Chapter 4 are distinct from the algorithm for TB infection testing and TPT in [Figure 3.4](#), as treatment decision algorithms are used in children identified as having presumptive TB.

Figure 3.4. Algorithm for TB infection testing and TB preventive treatment in children and adolescents

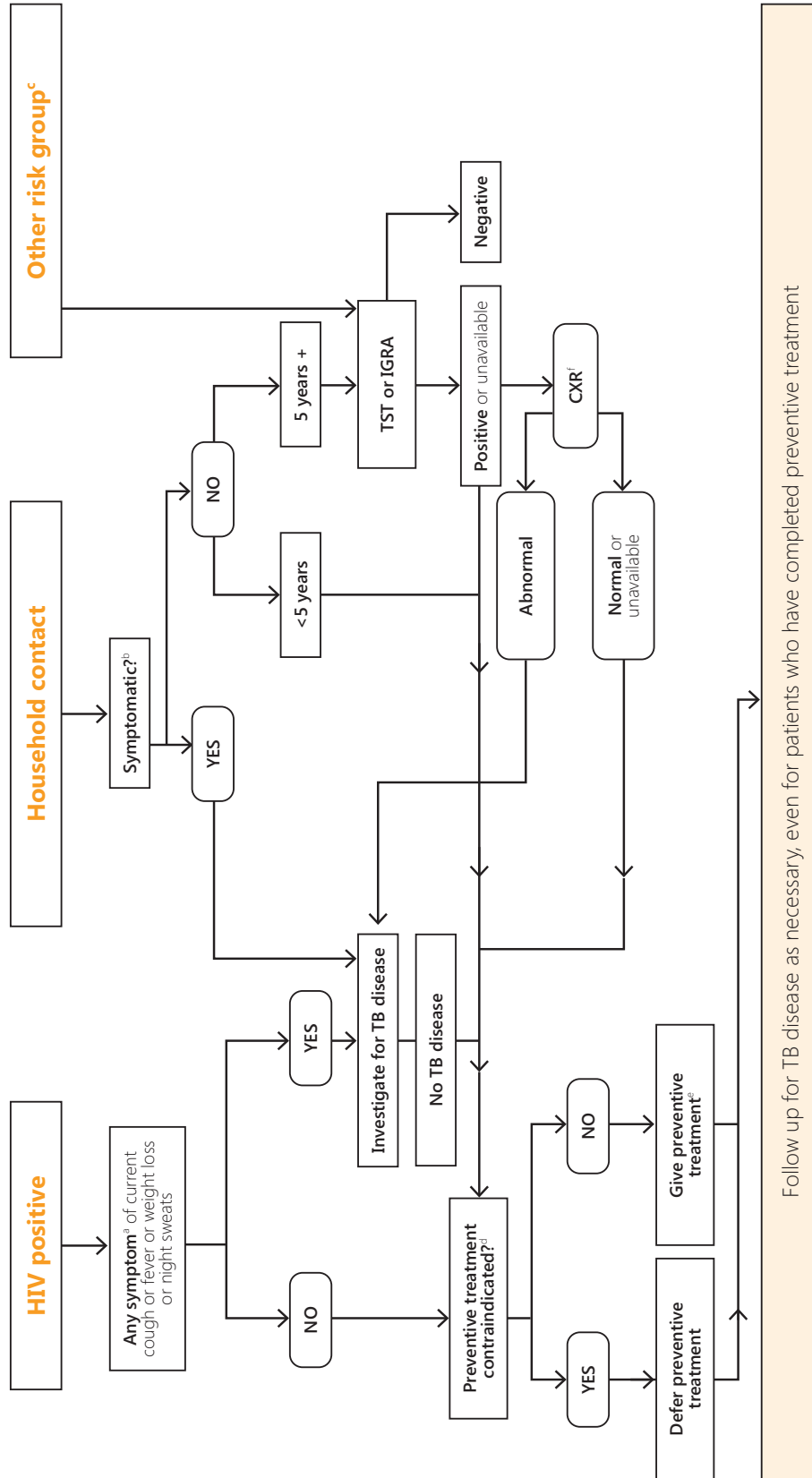

^a If aged under 10 years; any one of current cough, fever, history of contact with TB, reported or confirmed weight loss of more than 5% since last visit, growth curve flattening, or weight-for-age below -2 Z-scores. Asymptomatic infants aged under 1 year living with HIV are treated for TB infection only if they are household contacts of a person with TB. TST or IGRA may identify people living with HIV who will benefit most from TPT. CXR may be used in people living with HIV on antiretroviral therapy before starting TPT.

^b Any one of cough, fever, night sweats; haemoptysis, weight loss, chest pain, shortness of breath or fatigue. Children aged under 5 years should also be free of anorexia, failure to thrive, not eating well, and decreased activity or playfulness to be considered asymptomatic.

^c Including silicosis, dialysis, anti-tumour necrosis factor treatment, preparation for transplantation and other risks in national guidelines. People in this category should also have TB disease ruled out if they have suggestive clinical manifestations.

^d Including acute or chronic hepatitis; peripheral neuropathy (if isoniazid is used) and regular heavy alcohol consumption. Pregnancy and previous history of TB are not contraindications.

^e Regimen chosen based on considerations of age, strain (drug-susceptible or otherwise), risk of toxicity, availability and preferences.

^f CXR may have been carried out earlier as part of intensified case-finding.

3.3.4. Testing for TB infection

TST or IGRA can be used to test for TB infection. People living with HIV who are on ART (including adolescents and children) benefit from TPT regardless of whether they test positive or negative for TB infection. People living with HIV who are not on ART and who test positive for TB infection are shown to benefit more from TPT than those who test negative (49). WHO recommends that testing for TB infection should not be a requirement for initiating TPT among people living with HIV and child contacts aged under 5 years, particularly in countries with a high TB incidence, given that the benefits of TPT (even without testing) clearly outweigh the risks (15). For older contacts, TB infection testing may be used to determine eligibility for TPT if it is available. Non-availability of TB infection testing and CXR should not pose a barrier to TPT. The algorithm in Figure 3.4 caters for situations where these investigations are unavailable.

3.3.4.1. Tuberculin skin testing

TST is a method to detect TB infection that involves intradermal injection of tuberculin purified protein derivative (PPD). Previous exposure results in a local delayed-type hypersensitivity reaction within 24–72 hours (6). The reaction is identified as palpable induration at the site of injection. It only indicates hypersensitivity to proteins of the TB bacillus as a result of infection with *M. tuberculosis* or induced by BCG vaccination. A positive TST does not indicate the presence or extent of TB disease. A TST reaction after previous BCG vaccination is usually weaker than a reaction to natural infection and will remain positive for several years thereafter. Various clinical conditions, including HIV, may suppress a TST reaction. A negative result does not rule out TB infection or TB disease. In children living with HIV, or those with severe malnutrition or another severe illness, an induration of 5 mm or more is considered positive. For children without these conditions (irrespective of previous BCG vaccination), an induration of 10 mm or more indicates a positive result (6). Annex 2 provides detailed information on administering, reading and interpreting TST.

3.3.4.2. Interferon-gamma release assay

IGRA is a whole-blood test that can help to diagnose *M. tuberculosis* infection. Like TST, it does not differentiate between TB infection and TB disease. IGRA measures the cell-mediated immune response of people with TB infection. T-cells of infected people are sensitized to TB and respond to stimulation with peptides simulating those expressed by TB bacteria by secreting a cytokine called interferon-gamma. IGRA uses peptides from proteins made almost exclusively by *M. tuberculosis* and other mycobacteria from the *M. tuberculosis* complex. These proteins are absent from BCG vaccines and from most non-tuberculous mycobacteria. Special blood collection tubes coated with peptides from the TB antigenic proteins are used to collect and incubate the blood. Interferon-gamma is released when the blood from infected individuals is incubated with the antigens; this is not the case for people without TB infection. An enzyme-linked immunosorbent assay test is used to detect and quantify the amount of interferon-gamma released.

The advantages of IGRA include that the test requires only a single visit, results are available within 24 hours, and prior BCG vaccination does not cause a false-positive result. Disadvantages include that the test is more expensive, it requires phlebotomy, the blood sample must be processed quickly, laboratory facilities are required, and (as for TST) accuracy may be limited in people living with HIV (62).

In practice, the availability and affordability of tests will determine the choice by clinicians and programme managers. TST may require significantly fewer resources than IGRA, and may be more familiar to practitioners in resource-constrained settings, but recurrent global shortages and stockouts of tuberculin PPD have reduced its use in scaling up the programmatic management of TPT. See also Table 4.1 in the *WHO operational handbook on tuberculosis. Module 1: prevention – tuberculosis preventive treatment* (15). Novel skin tests will be reviewed by WHO in 2022.

3.3.5. Options for TB preventive treatment regimens: drug-susceptible TB

The following options for TPT are recommended by WHO for use in children and adolescents:

- 6 months or 9 months of isoniazid daily (6H or 9H) (all ages); or
- 3 months of isoniazid plus rifapentine weekly (3HP) (age 2 years and over); or
- 3 months of isoniazid plus rifampicin daily (3HR) (all ages).

1 month of daily isoniazid plus rifapentine (1HP) (aged 13 years and over) or 4 months of daily rifampicin (4R) (all ages) may be offered as alternative regimens.

When 6H was the main regimen used for TB preventive treatment, the term “isoniazid preventive therapy” (IPT) was often used to refer to TB preventive treatment in general. Since many alternative regimens to IPT are now recommended, the term “TB preventive treatment” is preferred.

3.3.5.1. Implementation considerations

The choice of TPT regimen depends on the age of the child, the HIV and ART status, and the availability and affordability of suitable (child-friendly) formulations.¹⁴ Rifampicin- and rifapentine-containing regimens should be prescribed with caution in children and adolescents living with HIV and on ART because of potential drug–drug interactions (see Section 7.1 and Tables 7.2 and 7.3). Table 3.1 summarizes the options for different target and age groups. Note that although 4R is an option, there is no suitable paediatric formulation and therefore this regimen is not included.

Table 3.1. TB preventive treatment options

Target group	Preferred regimen	Alternative regimen(s)	Notes
HIV-negative children aged ≤2 years	3HR if paediatric fixed-dose combination (FDC) ^a available	If paediatric FDC not available, use 6H (preferably dispersible tablets)	There is a lack of data on appropriate doses of rifapentine to allow use of 3HP in children aged <2 years There are no data for neonates; an expert should be consulted for advice on suitable TPT regimens
HIV-negative children aged ≥2 years and ≤25 kg body weight	3HR if paediatric FDC ^a available	If paediatric FDC not available, use 3HP or 6H	A paediatric formulation of rifapentine is not available A rifapentine 150 mg scored and dispersible formulation has been prioritized for development ^{b,c} A paediatric FDC for rifapentine and isoniazid is not planned for development

¹⁴ For available formulations and costs, see the Stop TB Partnership Global Drug Facility Medicines Catalog (<http://www.stoptb.org/assets/documents/gdf/drugsupply/GDFMedicinesCatalog.pdf>).

Target group	Preferred regimen	Alternative regimen(s)	Notes
HIV-negative children >25 kg body weight	3HP using adult formulations	3HR using adult FDC 1HP using adult formulation (age ≥13 years)	An adult isoniazid 300 mg/ rifapentine 300 mg scored FDC and an adult rifapentine 150 mg tablet are available
Children living with HIV	6H (preferably using dispersible tablets)	3HR for children on EFV-based ART 3HP for older children on EFV ART (and able to swallow tablets)	For more details on TPT regimens to use with ART, see Section 7.1 Data on 3HP in children on DTG are not yet available
Adolescents living with HIV	3HP if on TDF, EFV, DTG or RAL-based ART	1HP (age ≥13 years) if on TDF, EFV, DTG or RAL-based ART 6H	For more details on TPT regimens to use with ART, see Section 7.1 (including dose adjustments for 1HP with DTG or RAL)

1HP: 1 month of isoniazid and rifapentine daily; 3HP: 3 months of isoniazid and rifapentine weekly; 3HR: 3 months of isoniazid and rifampicin daily; 6H: 6 months of isoniazid daily; DTG: dolutegravir; EFV: efavirenz; FDC: fixed-dose combination; RAL: raltegravir; TDF: tenofovir disoproxil fumarate.

^a Dispersible FDC, isoniazid 50 mg/rifampicin 75 mg.

^b Report of the meeting to review the Paediatric Antituberculosis Drug Optimization priority list. Geneva: World Health Organization; 2021 (<https://www.who.int/publications/i/item/9789240022157>).

^c Rifapentine 150 mg tablet (scored and dispersible) is included in the 21st Invitation to Manufacturers of Antituberculosis Medicines to Submit an Expression of Interest (EOI) for Product Evaluation to the WHO Prequalification Unit (https://extranet.who.int/pqweb/sites/default/files/documents/EOI_TB_v21_29June2021.pdf).

Infants and young children aged under 5 years are particularly vulnerable due to an increased risk of progressing to TB disease and developing severe forms of TB such as TBM or disseminated TB. In addition, it is often difficult to confirm a diagnosis of TB disease given its paucibacillary nature (63, 64). Averting paediatric TB by delivering TPT is therefore important.

For TPT among children, the 3HR regimen provides a better-tolerated, shorter, more child-friendly option than 6H or 9H, since dispersible FDC formulations are available for young children. A study in four African countries among child contacts starting 3HR demonstrated high uptake and completion rates, and low rates of mild adverse events (65).

As data on an appropriate rifapentine dosage for younger children are lacking, in the short term national programmes could consider scaling up 3HR for TPT among children of all ages (66). Those weighing under 25 kg, including children aged under 2 years, may receive the same formulation used for the continuation phase of TB treatment (2 FDC isoniazid 50 mg/rifampicin 75 mg). Children weighing over 25 kg may receive 3HP (if it is rolled out for adults) or 3HR using adult FDCs of rifampicin and isoniazid. The child-friendly FDC of rifampicin and isoniazid has the added benefit of already being in the national supply chain for the continuation phase of TB treatment for children weighing under 25 kg.

For children living with HIV on lopinavir/ritonavir (LPV/r), dolutegravir (DTG) or nevirapine (NVP) ART, the 6-month isoniazid regimen (6H) is still the most suitable option, as pharmacokinetics and safety studies on rifapentine-based TPT regimens in this population are ongoing. Because of likely drug–drug interactions, due vigilance for signs of isoniazid-induced hepatitis is necessary.

Over the medium to long term, 3HP (or 1HP) may become the preferred regimen across all ages, irrespective of HIV status, provided evidence on an appropriate dose for children aged under 2 years, safety and tolerability is established, and once a dispersible formulation of rifapentine becomes available.

The once-weekly administration, shorter duration of treatment and higher rates of treatment completion with 3HP will likely make it more cost-effective in the long term.

The Paediatric Antituberculosis Drug Optimization Expert Group prioritized a standalone rifapentine formulation that is scored and dispersible, as this will offer the best flexibility for the use of rifapentine for both TPT and possible future first-line TB treatment (66).

Key point: preferred TB preventive treatment options

3HR is a preferred TPT option among HIV-negative children since child-friendly dispersible FDCs are widely available and already used for TB treatment, while awaiting data on dosages across all age groups and child-friendly formulations for rifapentine-based regimens. For children living with HIV, 6H remains the preferred option until further data are available.

3.3.5.2. Dosages

The WHO task force on pharmacokinetics and pharmacodynamics analysed available evidence from clinical trials of rifapentine and suggested a simplified dose for various weight bands for 3HP and 1HP for the 2020 *WHO consolidated guidelines on tuberculosis. Module 1: prevention – tuberculosis preventive treatment* (28). Table 3.2 presents standard dosing for the recommended TPT regimens by age and body weight.

Table 3.2. Dosing for recommended TB preventive treatment regimens

TPT regimen	Dose by age and weight band ^a					
3HR	Isoniazid:					
	• Age <10 years: 10 mg/kg/day (range 7–15 mg)					
	• Age ≥10 years: 5 mg/kg/day					
3HR	Rifampicin:					
	• Age <10 years: 15 mg/kg/day (range 10–20 mg)					
	• Age ≥10 years: 10 mg/kg/day					
	Weight band ^b	4–<8 kg	8–<12 kg	12–<16 kg	16–<25 kg	≥25 kg
	Isoniazid 50 mg/ rifampicin 75 mg (FDC)	1	2	3	4	Use adult formulations

TPT regimen	Dose by age and weight band ^a					
3HP	Age 2–14 years ^{c,d}					
	Medicine, formulation	10–<16 kg	16–<24 kg	24–<31 kg	31–<34 kg	≥34 kg
	Isoniazid 100 mg ^e	3	5	6	7	7
	Rifapentine 150 mg	2	3	4	5	5
	Age >14 years					
	Medicine, formulation	30–<36 kg	36–<46 kg	46–<56 kg	56–<70 kg	≥70 kg
	Isoniazid 300 mg	3	3	3	3	3
	Rifapentine 150 mg	6	6	6	6	6
	Isoniazid 300 mg + rifapentine 300 mg FDC	3	3	3	3	3
	1HP	Age ≥13 years (regardless of weight band):				
	• Isoniazid 300 mg/day					
	• Rifapentine 600 mg/day					
6H or 9H ^f	Age <10 years: 10 mg/kg/day (range 7–15 mg)					
	Age ≥10 years: 5 mg/kg/day					
	Weight band	4–<8 kg	8–<12 kg	12–<16 kg	16–<25 kg	≥25 kg
100 mg (dispersible) tablet	0.5	1	1.5	2	3 (or use 1 300 mg tablet)	
4R	Age <10 years: 15 mg/kg/day (range 10–20 mg)					
	Age ≥10 years: 10 mg/kg/day					

1HP: 1 month of daily isoniazid and rifapentine (28 doses); 3HP: 3 months of weekly isoniazid and rifapentine (12 doses); 3HR: 3 months of daily isoniazid and rifampicin; 4R: 4 months of daily rifampicin; 6H: 6 months of daily isoniazid; 9H: 9 months of daily isoniazid.

^a Presentation of weight bands has been updated – for example, the 4–7 kg weight band is now written as 4–<8 kg. There is no change to the weight range represented in the weight band.

^b For infants weighing less than 4 kg, consult a paediatric TB specialist.

^c Dosage may differ among adults and children in overlapping weight bands.

^d For children aged 2 years and over but weighing less than 10 kg, consult a paediatric TB specialist before using 3HP.

^e A 300 mg formulation can be used to reduce the pill burden.

^f A triple pill combination containing isoniazid 300 mg + pyridoxine 25 mg + sulfamethoxazole 800 mg + trimethoprim 160 mg (co-trimoxazole) (scored) is the preferred alternative regimen for people living with HIV being considered for isoniazid monotherapy (1 tablet daily for adults, 0.5 tablet daily for children aged over 5 years, 0.25 tablet daily for children aged under 5 years).

A side-effect of long-term treatment with high-dose isoniazid is peripheral neuropathy, which develops secondary to a deficiency of vitamin B6 (pyridoxine) during treatment. People at risk for peripheral neuropathy, such as those with malnutrition, HIV, renal failure or diabetes, or who are pregnant or breastfeeding, should receive vitamin B6 supplements when taking an isoniazid-containing regimen. Additionally, exclusively breastfed infants should receive vitamin B6 while taking isoniazid (75). In children living with HIV and malnourished children, daily pyridoxine supplementation may be added for the duration of TPT containing isoniazid (5–10 mg daily in children aged under 5 years; 25 mg daily in children aged over 5 years) (6).

3.3.6. Options for TB preventive treatment regimens: drug-resistant TB

Household contacts of people with MDR-TB or isoniazid mono-resistance are at higher risk of TB infection than contacts exposed to people with drug-susceptible TB. The risk of progression to TB disease does not differ among contacts in either group (67). Studies have reported approximately 90% reduction in MDR-TB incidence with TPT after known exposure (68). WHO recommends using TPT for contacts exposed to people with MDR-TB following consideration of the intensity of exposure, confirming the source patient and their drug resistance pattern (i.e. MDR-TB confirmed bacteriologically and susceptibility to a fluoroquinolone established), and confirming TB infection using IGRA or TST where possible.

WHO suggests the use of levofloxacin for 6 months (paediatric formulation for child contacts) along with other TB medicines such as ethambutol (or ethionamide if tolerated). Regardless of whether treatment is given or not, clinical follow-up should be carried out for 2 years. Any emergent signs and symptoms suggestive of TB should be actively investigated and a treatment regimen started as needed. Table 3.3 provides dosing recommendations for the use of levofloxacin as TPT for contacts of DR-TB.

Table 3.3. Dosing recommendations for use of levofloxacin as TB preventive treatment for drug-resistant TB

TPT regimen	Dose by age and weight band
6 months of levofloxacin daily (preventive treatment of MDR-TB)	<p>Age <15 years (approximate range 15–20 mg/kg/day), by body weight (use levofloxacin 100 mg dispersible tablets for children):</p> <ul style="list-style-type: none"> • 5–<10 kg: 150 mg/day • 10–<16 kg: 200–300 mg/day • 16–<24 kg: 300–400 mg/day • 24–<35 kg: 500–750 mg/day <p>Age >14 years, by body weight:</p> <ul style="list-style-type: none"> • <46 kg: 750 mg/day • >45 kg: 1 g/day

Contacts of people with rifampicin-resistant TB (RR-TB) may be treated similarly to contacts of people with MDR-TB. If isoniazid susceptibility is confirmed in the index patient, contacts may be given 6H or 9H. Among contacts of people with known isoniazid-resistant rifampicin-susceptible TB, little evidence on the choice of TPT regimens exists. 4R may be an option for TPT in these situations.

3.3.7. Follow-up of children and adolescents on TB preventive treatment

Children and adolescents on TPT should be reviewed every month for those on a 3-month regimen (e.g. 3HR or 3HP), or every 2 months for those on a 6-month regimen (e.g. 6H) or DR-TB TPT, ideally at a health care facility or by treatment supporters (see Section 6.4) or by using digital tools such as video-supported treatment (69). If possible and feasible, aligning visits with care for the index patient is an important consideration, especially when the child or adolescent contact and the index patient are from the same family.

It may be challenging for families to understand why a child who is well should take medicine every day or every week for 3–6 months to protect them from developing TB disease, and it is important to explain the reasons clearly. The importance of adherence should be reinforced at every visit. Children can also be reviewed at home with the provision of monthly TPT supplies. In some settings, this can be coordinated with home treatment support of adult index or source patients.

Follow-up visits should include the following (a “TPT passport” or similar TPT record may help with the consistent achievement of these aims – see [Annex 1](#) for available resources):

- Monitor for TB symptoms (e.g. cough, fever, fatigue, poor weight gain, reduced playfulness):
 - evaluation for TB disease if symptoms or signs suggestive of TB develop;
 - management of breakthrough TB (TB disease that develops while on TPT) – in this case, it is recommended to stop TPT and initiate TB treatment, and to send specimens for Xpert MTB/RIF or Ultra, line probe assay (LPA) or DST as appropriate and feasible.
- Monitor weight to check appropriate TPT dosage (to adjust if crossing weight bands) and for evidence of TB disease.
- Monitor for and manage adverse events as relevant to the prescribed TPT regimen – see Chapter 6 in the *WHO operational handbook on tuberculosis. Module 1: prevention – tuberculosis preventive treatment (15)*.
- Monitor for adherence to treatment and conduct pill counts. If adherence to treatment is poor or there is an interruption to TPT, the HCW should enquire about the possible reasons and discuss options with the child’s parent or guardian, taking the opportunity to express support for the family and to address any issues that may require referral or treatment. Counselling should be offered in a way that makes the family feel empowered in their choice to continue with TPT (see [Section 3.3.8](#)).
- Ensure recording and reporting – all children and adolescents on TPT should be registered to collect information about monitoring the uptake of, adherence to and outcome of TPT (including breakthrough TB), and requirements for procurement to avoid stockouts of medicines. Data can be recorded in contact investigation registers or in separate TPT registers. Refer to the *WHO operational handbook on tuberculosis. Module 1: prevention – tuberculosis preventive treatment* for a minimum set of indicators for monitoring programmatic management of TPT, focused on assessment of contacts of people with TB, assessment of people living with HIV and other at-risk groups, and initiation and completion of TPT.
 - The PREVENT-TB tool, an application which allows monitoring throughout the cascade of preventive care, is available at <https://www.who.int/activities/preventing-tb#app>. Indicators for TB screening and TPT are available on the TB Knowledge Sharing Platform (see <https://tbksp.org/en/node/628> and Figure 2.5 at <https://tbksp.org/en/node/1401>).

3.3.8. Adherence to TB preventive treatment

Adherence to any course of treatment is a complex behaviour influenced by many factors, such as personal motivation, beliefs about health, perceived risks and benefits of treatment, comorbidities, competing demands that conflict with taking medicines, the family environment, complexity of the treatment regimen, toxicity of medicines, and trust and relationship with providers. Effective person-centred strategies to promote adherence to TPT may include the following (15):

- Ensure confidentiality when seeking a person’s commitment to complete the TPT course before initiating TPT.
- Ensure the person understands the role of TPT options and the duration required for completion. Provide information materials in the primary language and at the literacy level of the person or family concerned.
- Include family members and caregivers in health education when possible. Children often move between households and health facilities, and it may be helpful to include additional family members and caregivers in health education activities.
- Reinforce supportive educational messages at each visit.

- Give clear information regarding side-effects and triggers on when to stop treatment and contact the HCW or provider, including the use of digital tools for support.
- Invite the person to ask questions, and provide clear and simple answers. Provide a telephone number to contact health services for advice.
- Develop a personal adherence plan with the support of the family, caregivers and health worker as per the treatment regimen.

3.3.8.1. Special considerations for adherence in children

Infants and children are dependent on caregivers to administer medicines. Barriers faced by adult caregivers can contribute to children missing doses. Considerations for adherence in adolescents are covered in [Section 7.4](#).

Potential barriers for children include the following:

- Absence of child-friendly formulations – this makes medicines more difficult to administer and increases the chances that the child will refuse treatment with crushed pills.
- Lack of conviction among the caregiver or HCW about the importance of TPT – the child’s adherence will be ensured only if the caregiver and the HCW are invested in the successful completion of TPT.
- Family factors:
 - not having one or more appropriate caregivers – given that young children may move around different homes within the family, the involvement of multiple caregivers may be necessary;
 - caregivers’ lack of knowledge;
 - age and developmental stage at which children can be more responsible for taking their own medicines while still being supervised by an adult;
 - changes in routine for the family or child (e.g. school holidays) that disrupt administration schedules;
 - issues related to stigma.

Strategies for managing and enhancing adherence among children include the following (see also resources on counselling in [Annex 1](#)):

- Explain and emphasize to the caregiver and child why they must take the full course of treatment.
- For dispersible child-friendly FDCs, ensure the HCW can explain and provide clear instructions to caregivers on how to dissolve the medicine in water.
- Provide a child- and family-friendly schedule for appointments for medicine refills – for example, on the same day as other family members who are on TB treatment or TPT.
- Take note of risk factors for poor adherence and attempt to address them, such as distance to the facility, transport costs, death of a parent (especially the mother), past adverse reactions to medicines, illness in the primary caregiver, and being unwell. Address stigma through education and plain labelling of medicines.
- Provide adolescents with education and adherence support directly, especially if they are living with HIV.
- For young children refusing to take medicines:
 - if taken with food, change the food type to better mask the taste, or place crushed tablets in solid food that is easy to swallow instead of mixing with water;
 - provide a treat for taking the medicine completely;
 - if the child vomits within 30 minutes of a dose, ensure a new dose is given. Try giving the medicine at a different time of day. Families should be given a few extra doses every month, and the programme should estimate the extent of such losses and reflect this in procurement plans. Continued vomiting requires a consultation at a health care facility.
- Prepare an adherence plan with the caregiver and ask that it be shared with other caregivers. For an example of an adherence plan, see Chapter 7 in the *WHO operational handbook on tuberculosis. Module 1: prevention – tuberculosis preventive treatment (15)*.
- Review the adherence plan at each encounter, especially if there is a new caregiver present.
- Review knowledge and barriers at each visit. Examples of questions to ask include:

- Who is the primary caregiver?
- Does the child sometimes sleep in another family member's home?
- Is the caregiver aware that the treatment is daily (3HR) or weekly (3HP) for 3 months?
- Is the caregiver aware of dose and pill number at each time?
- Is the caregiver being counselled regarding the need for adherence, adverse reactions, when to seek advice from a HCW, and what to do if the child vomits after taking the medicine?

Table 3.4 summarizes all recommended regimens and suggested criteria to assess their completion. Shorter regimens are associated with better adherence and higher treatment completion, based on 80 or 90% of recommended doses taken within 133% of planned TPT duration. Table 3.5 summarizes the suggested management of interruptions in TPT.

Table 3.4. TB preventive treatment completion criteria

Regimen	Total duration (months)	Expected number of doses	80% of recommended doses	Extended time for treatment completion (days): original treatment duration + 33% additional time
6H (daily)	6	182	146	239
3HR (daily)	3	84	68	120
3HP (weekly)	3	12	11 ^a	120
1HP (daily)	1	28	23	38
4R (daily)	4	120	96	160

1HP: 1 month of daily isoniazid and rifapentine; 3HP: 3 months of weekly isoniazid and rifapentine; 3HR: 3 months of daily isoniazid and rifampicin; 4R: 4 months of daily rifampicin; 6H: 6 months of daily isoniazid.

^a 90% of recommended number of doses for 3HP.

Table 3.5. Management of interruptions in TB preventive treatment

TPT regimen	Duration of treatment interruption	Next step	Suggested actions
3HR, 4R, 6H	Less than 2 weeks	<p>Resume preventive treatment immediately upon return and add the number of days of missed doses to the total treatment duration.</p> <p>Do not change the scheduled date of the next follow-up visit but the last follow-up visit will be postponed by the number of extra days to compensate for missed doses (e.g. If a child on 3HR missed 3 days of treatment, continue preventive treatment for a total duration of 3 months + 3 days from the date of start).</p>	<p>Address the reason for interruption</p> <p>Counsel the person on TPT and the caregiver on the importance of adherence to preventive treatment</p> <p>Review and agree with the person on TPT and the caregiver about the best ways to improve adherence</p>
	More than 2 weeks	<p>If treatment interruption occurred after more than 80% of doses expected in the regimen were taken, no action is required. Continue and complete the remaining treatment as per original plan.</p> <p>If less than 80% of doses expected in the regimen were taken, and the treatment course can still be completed within the expected time for completion, i.e. treatment duration + 33% additional time, no action is required. Continue and complete the remaining treatment as per original plan.</p> <p>If less than 80% of doses expected in the regimen were taken, and the treatment course cannot be completed within the expected time for completion, consider restarting the full TPT course.</p>	

TPT regimen	Duration of treatment interruption	Next step	Suggested actions
3HP	Weekly schedule of one dose missed	<p>If the missed dose is remembered within the next 2 days, the person can take the dose immediately. Continue the schedule as originally planned (i.e. continue to take remaining doses following the same schedule).</p> <p>If the missed dose is remembered more than 2 days later, the person can take the missed dose immediately and change the schedule for weekly intake to the day the missed dose was taken until treatment completion. This will avoid 2 weekly doses being taken less than 4 days apart.</p>	
	More than 1 weekly doses of 3HP missed	<p>If between 1–3 weekly doses are missed, treatment is continued until all 12 doses are taken, thus prolonging the treatment duration to a maximum of 16 weeks.</p> <p>If, however, 4 or more weekly doses are missed, consider restarting the full TPT course.</p> <p>If adherence to a weekly routine is not possible, consider discontinuing 3HP and offering an alternative (daily) regimen.</p>	
1HP	Less than 1 week	<p>If more than 80% (23) of doses expected in the regimen were taken no action is required, just complete the remaining doses.</p> <p>If less than 80% (23) of doses expected in the regimen were taken, resume treatment immediately upon return and add the missed doses to the total treatment duration to complete the course within a maximum of 6 weeks.</p>	
	More than 1 week	<p>If more than 7 consecutive doses were missed, consider restarting the complete course of 1HP regimen.</p> <p>If more than 7 doses were missed intermittently, resume preventive treatment immediately upon return and add the missed doses to the total treatment duration to complete the course within a maximum of 8 weeks.</p> <p>If adherence to 1HP is not possible, consider discontinuing it and offering an alternative daily regimen or 3HP.</p>	

3.3.9. Other issues related to TB preventive treatment in children and adolescents

The management of babies born to women with TB is covered in [Section 7.2](#). The main implications of TPT for the choice of ART in children and adolescents living with HIV are covered in [Section 7.1](#).

For other issues related to TPT in children and adolescents, including management of adverse events, drug–drug interactions, provision of TPT in special populations and situations, and monitoring and evaluation, see the *WHO operational handbook on tuberculosis. Module 1: prevention – tuberculosis preventive treatment (15)*.

3.4. TB infection prevention and control

The End TB Strategy emphasizes the need for prevention across all efforts to end the TB epidemic, including infection prevention and control in health care services and other high-transmission settings (7). Infection prevention and control practices are critical to reduce the risk of *M. tuberculosis* transmission, by reducing the concentration of infectious droplet nuclei in the air and the exposure of susceptible people to such aerosols. Although the recommendations in the *WHO guidelines on tuberculosis infection prevention and control: 2019 update* do not specifically mention children or adolescents, the principles of infection control outlined remain relevant (70). Specifically, adolescents aged 10–19 years pose the same transmission risk as adults with TB, given similar disease profiles. Children aged under 10 years are unlikely to transmit disease, but the same principles apply to health care facilities where children and their families seek care. In addition, poor infection prevention and control practices that facilitate transmission invariably affect children when an adult or adolescent transmits TB to a child.

The COVID-19 pandemic has resulted in routine mask-wearing in many settings, which may have reduced the stigma related to the use of masks by people with TB. This may facilitate implementation of cough etiquette by people attending health care facilities and respiratory protection by HCWs.

Box 3.4 WHO recommendations on TB infection prevention and control

To reduce *M. tuberculosis* transmission to health workers, persons attending health care facilities or other persons in settings with a high risk of transmission, the following measures are recommended:

- Administrative controls:
 - triage of people with TB signs and symptoms, or with TB disease;
 - respiratory separation or isolation of people with presumed or demonstrated infectious TB;
 - prompt initiation of effective TB treatment of people with TB disease;
 - respiratory hygiene (including cough etiquette) in people with presumed or confirmed TB.
- Environmental controls:
 - upper-room germicidal ultraviolet systems;
 - ventilation systems (including natural, mixed-mode, mechanical ventilation and recirculated air through high-efficiency particulate air filters).
- Respiratory protection:
 - particulate respirators, within the framework of a respiratory protection programme.

Source: WHO guidelines on tuberculosis infection prevention and control: 2019 update. Geneva: World Health Organization; 2019 (<https://apps.who.int/iris/bitstream/handle/10665/311259/9789241550512-eng.pdf>).

In high TB prevalence settings, children and adolescents who attend health facilities are at risk of TB transmission, and adolescents are likely to pose a transmission risk themselves. The risk of developing TB after infection is especially high for infants and young children, and for all children and adolescents living with HIV who visit health facilities. People with (presumptive) TB should not share a waiting area with infants attending for immunizations or well-baby checks, or children and adolescents at HIV clinics. All children (rare) and adolescents (common) with cavitary or sputum smear-positive TB disease should be isolated. The risk of exposure is particularly high in facilities caring for adults with TB and/or HIV. TB is the most common opportunistic infection in adults living with HIV and of childbearing or parenting age.

Children with TB are often considered not to be infectious and therefore not likely to transmit TB, but adolescents and sometimes younger children do transmit TB. Infection control is therefore important in health facilities and areas dedicated solely to the management of children. The greatest risk occurs in areas where young and vulnerable children mix with adults and adolescents with presumptive TB who are not on treatment. In addition, there is a high risk of unsuspected and untreated TB disease among adults accompanying or visiting such children. The clinical presentation of TB in children is variable and often overlaps with that of pneumonia, HIV and malnutrition, and therefore infection control measures are relevant to all outpatient and inpatient areas where children attend (6).

Specific high-risk areas include:

- newborn care settings – neonates are highly vulnerable for acute onset or development of disseminated severe disease, and adults with cough should not be allowed to visit;
- health facilities that care for adults and adolescents with presumptive TB, who are often infectious (especially before being diagnosed and started on treatment);
- antenatal care settings and prevention of mother-to-child transmission sites;
- HIV clinics;
- facilities that care for children with severe malnutrition;
- other congregate settings, including childcare facilities, orphanages, prisons and schools – school-aged children with bacteriologically confirmed TB should not attend school until they are no longer infectious (usually 2 weeks after starting effective TB treatment for drug-susceptible TB); it is important, however, that children and adolescents with TB return to school as soon as possible, if they are well enough to do so after at least 2 weeks of treatment, to minimize disruption of education; school management must be informed accordingly, including that mask-wearing is not needed for children and adolescents who are not infectious (both for the child with TB and for other children in the class);
- children in displaced and mobile populations, including migrant labour camps, informal and crowded refugee camps, and temporary shelters.

Key messages

- TB prevention is a critical component of global TB control efforts.
- BCG vaccination is recommended for neonates in high-incidence settings and in high-risk neonates in low-incidence settings.
- There are important implementation considerations for timing of BCG administration in infants exposed to HIV, infants living with HIV, and neonates exposed to mothers with infectious TB.
- WHO recommends TPT to decrease the risk of progression from TB infection to TB disease.
- Target groups for TPT include those with an increased risk of progression to TB disease after TB infection and those with an increased likelihood of TB exposure or infection.
- Shorter child-friendly TPT regimens are recommended for children. Recommendations for adolescents are similar to those for adults.
- The choice of TPT regimens in children and adolescents depends on the age, HIV and ART status, and availability of suitable (child-friendly) formulations.
- TB infection prevention and control is especially important in health care facilities and consists of administrative and environmental controls (most important) and respiratory protection.

4. TB diagnostic approaches for children and adolescents

4.1. Introduction

Diagnostic evaluation is the step in the care cascade after screening. Children and adolescents who screen positive during contact investigation or at health facility-based screening, and those who present to a health care facility with signs and symptoms of TB and who are identified as having presumptive TB must be evaluated further for TB disease.

The diagnosis of TB disease is usually made based on careful clinical assessment, supported by relevant tests and investigations. Most young children with TB have paucibacillary disease, meaning they harbour relatively few TB bacilli. Consequently, diagnostic tests that detect TB bacilli are not as sensitive in young children as in older adolescents and adults with TB. Young children cannot easily produce sputum samples, and the use of alternative sample types that can be collected in a less invasive way is important for obtaining bacteriological confirmation.

This chapter describes TB diagnostic approaches for children and adolescents, including children with drug-susceptible TB, DR-TB, PTB and EPTB. PTB is the most common type of TB in children and adolescents. In children usually involves disease in the intrathoracic lymph nodes, but in adolescents it more commonly resembles adult-type disease with cavitary lesions (4, 6). This chapter relates to the section of the pathway highlighted in blue in Figure 4.1.

Figure 4.1. Pathway through exposure, infection and disease covered in Chapter 4

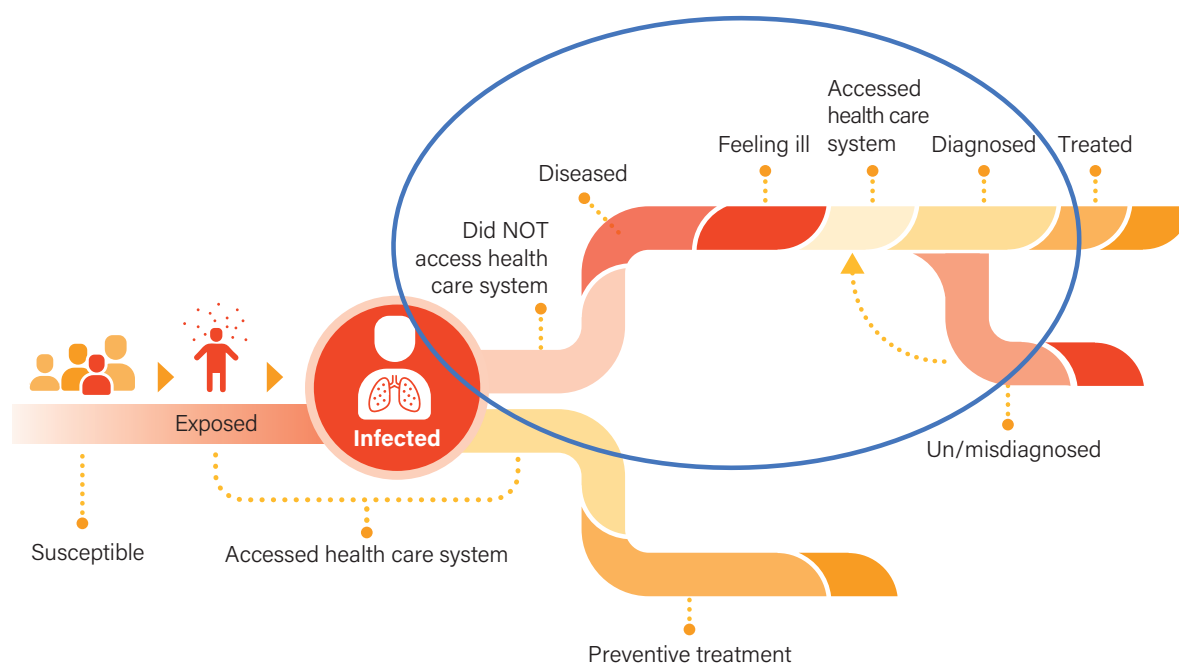

Source: Roadmap towards ending TB in children and adolescents. Geneva: World Health Organization; 2018 (<https://apps.who.int/iris/handle/10665/275422>).

4.2. Diagnosing TB in children and adolescents

Young children have a higher risk of developing TB compared with other age groups (4). Risk of TB disease is more pronounced among children and adolescents who:

- are a household or other close contact with a person with PTB, especially if bacteriologically confirmed;
- are aged under 5 years;
- are living with HIV, especially if poorly controlled;
- have severe acute malnutrition (SAM), especially if not responding to nutritional rehabilitation;
- are hospitalized with pneumonia, especially if not responding to antibiotic treatment.

Diagnosing TB in children and adolescents relies on a combination of (6):

- careful history, including any TB contact (especially in the past 12 months), previous TB treatment, and signs and symptoms consistent with TB;
- clinical examination, including growth assessment;
- HIV testing if status unknown;
- bacteriological testing (if available);
- CXR (preferably anteroposterior and lateral in children aged under 5 years and posteroanterior in older children and adolescents);
- TB infection testing (TST or IGRA);
- investigations relevant for presumed EPTB.

A decision to start TB treatment based on clinical parameters should not be delayed if the necessary investigations are not available, particularly for children at higher risk of developing severe disease, such as those aged under 2 years, living with HIV, with SAM, or hospitalized with pneumonia (not responding to first-line treatment for pneumonia). A trial of treatment with TB medicines is not recommended as a method of diagnosing TB in children.

4.3. Diagnostic approaches: pulmonary TB

PTB refers to any bacteriologically confirmed or clinically diagnosed case of TB involving the lung parenchyma or tracheobronchial tree. Tuberculous mediastinal and/or hilar intrathoracic lymphadenopathy is also classified as PTB, following an expert consultation convened by WHO in September 2021.¹⁵ Miliary TB is classified as PTB because there are lesions in the lungs. Tuberculous pleural effusion without radiographic abnormalities in the lungs constitutes EPTB. A person with both PTB and EPTB should be classified as having PTB (71).

4.3.1. Typical symptoms of pulmonary TB

In most cases, children with TB disease develop chronic unremitting symptoms that persist for more than 2 weeks without sustained improvement or resolution following treatment for alternative diagnoses (e.g. antibiotics for pneumonia, antimalarials for fever, nutritional rehabilitation for failure to thrive or malnutrition). The most common clinical presentation of PTB in children is persistent cough and poor weight gain. Figure 4.2 illustrates different cough patterns, which may be useful to visualize how a persistent, non-remitting cough presents. In high-risk groups such as children living with HIV and infants, PTB may present as acute pneumonia. The approach to diagnosis of TB in children living with HIV is similar to that for children without HIV infection (6, 72), but there should be an increased risk perception. Box 4.1 summarizes the most common symptoms of TB in children.

¹⁵ In children aged under 10 years; further updates to the classification relevant for other age groups are expected in 2022.

Figure 4.2. Differentiated cough patterns

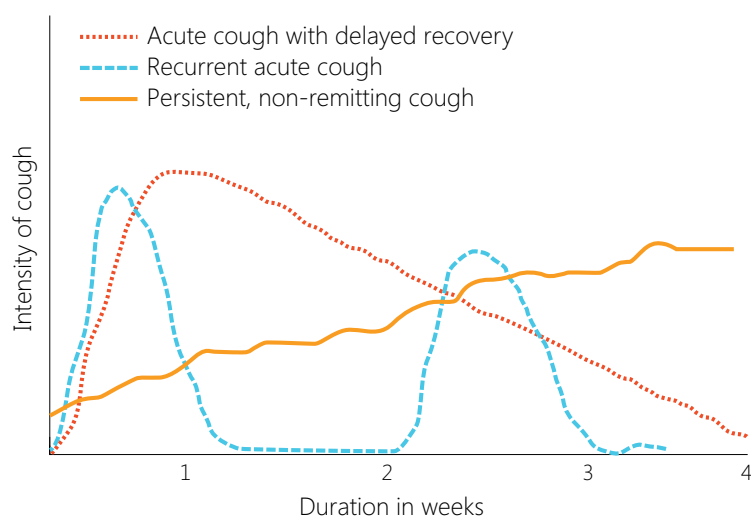

Research has shown that identification of symptoms with a persistent, non-remitting character is possible at PHC level, even in resource-limited settings. A persistent, non-remitting cough was uncommon in this study but was almost exclusively (88.9%) associated with TB.

Source: Marais BJ, Gie RP, Obihara CC, et al. Well defined symptoms are of value in the diagnosis of childhood pulmonary tuberculosis. *Arch Dis Child.* 2005;90(11):1162–1165.

Box 4.1 Symptoms of TB in children

The most common symptoms of TB in children are (6, 72):

- ➔ cough, especially if persistent and not resolving;
- ➔ prolonged fever with or without night sweats;
- ➔ not eating well or anorexia;
- ➔ weight loss or failure to thrive (see Figure 4.3 for examples of abnormal growth curves suggestive of TB);
- ➔ unusual fatigue, reduced playfulness or decreased activity.

4.3.2. History of TB contact

The index patient is the initially identified person of any age with new or recurrent TB in a specific household or other comparable setting to which others may have been exposed. An index case is the person on whom a contact investigation is centred but is not necessarily the source case (28).

Close contact with a source case with TB often involves sharing a living, learning or working space with them. Contact may also occur with a source case from outside the household (e.g. a neighbour, caregiver or relative) with whom the child has had frequent contact. In older children and adolescents, the contact with a source case is often outside the household, such as at school, on public transport or at a club. It is important to determine the resistance pattern (or the treatment regimen if DST is not available) of the source case and their response to treatment to assess the risk of DR-TB. If no source case is identified, it is important to ask about anyone in the household with a chronic cough. That person must then be evaluated for possible TB disease. Children usually develop TB within 2 years after exposure, and most (90%) within the first year following exposure and infection (6, 16, 28, 72).

TB screening and contact investigation and TPT are covered in [Chapters 2 and 3](#). During contact investigation, the following considerations are important to support early and accurate TB diagnosis in children (6, 15):

- All children and adolescents who have been in close contact with a TB case and are symptomatic must be evaluated for TB disease.
- Children and adolescents of all ages living with HIV who have been in close contact with a TB case must complete an evaluation for TB.
- When a child or adolescent is diagnosed with TB, or a decision to start TB treatment has been made, efforts should be made to detect the source case (if not already identified), any other people with undiagnosed TB in the household, and any people eligible for TPT. If resources allow, contact investigation may extend beyond the household.

4.3.3. Clinical examination

Although there are no findings on clinical examination that can confirm TB, some clinical signs are highly suggestive. In addition, a variety of nonspecific signs should raise clinical suspicion and prompt an evaluation for TB disease. The following clinical features can alert care providers that the child may have TB (6, 72):

- Poor weight gain – check and record weight and compare with previous weight in the past 3 months. Look for weight loss and check for growth faltering or failure to thrive (flattening of the curve). See [Figure 4.3](#) for examples of abnormal growth curves suggestive of TB.
- Vital signs – check for elevated temperature (fever) and increased respiratory rate (see [Box 4.8](#)).
- Signs of respiratory distress:
 - specific integrated management of childhood illness (IMCI) signs to monitor in children aged under 5 years are chest indrawing, stridor and oxygen saturation below 90%; these are usually not due to TB but are important to guide clinical management;
 - auscultation and percussion are usually normal but may reveal lung disease (e.g. crackles, bronchial breathing, fixed area of wheezing due to airway narrowing from enlarged lymph nodes) or pleural effusion (dullness, reduced breath sounds).
- Other physical signs suggestive of PTB include:
 - SAM, especially if not responding to therapeutic nutritional treatment;
 - acute pneumonia not responding to adequate course of antibiotics;
 - persistent wheeze not responding to bronchodilators (especially if fixed and non-symmetrical).
- Other physical signs suggestive of EPTB (see [Table 4.6](#)) include:
 - non-tender enlarged cervical lymph node mass (especially if more than 2 × 2 cm) with or without fistula formation – TB lymphadenopathy;
 - presence of narrow angle spinal kyphosis (angular swelling), especially if recent onset (“gibbus”) – spinal TB;
 - signs of non-acute meningitis (onset over more than 5 days), especially if not responding to antibiotic treatment and/or with raised intracranial pressure – TBM;
 - pleural effusion, especially one-sided dullness with pleuritic pain in a child who is not acutely ill – pleural TB;
 - pericardial effusion, distant or muffled heart sounds or signs of new-onset heart failure – pericardial TB;
 - non-acute distended abdomen with or without ascites – abdominal TB;
 - non-tender swollen joints with painful or abnormal gait – osteoarticular TB.

Weight loss or failure to thrive

It is important to check the child's weight, record it and compare with previous weights. Poor weight gain can be defined in any of the following ways:

- reported noticeable weight loss;
- very low weight (weight-for-age (WFA) below -3 Z-score);
- underweight (WFA below -2 Z-score);
- confirmed weight loss (more than 5%) since last visit;
- flattening of growth curve.

Other causes of chronic lung disease

Clinical features that suggest other causes of chronic lung disease include:

- generalized lymphadenopathy, oral thrush and parotid enlargement – HIV infection;
- finger clubbing – lymphoid interstitial pneumonitis or bronchiectasis;
- recurrent cough or wheeze responsive to bronchodilators – asthma.

Figure 4.3. Examples of abnormal growth curves

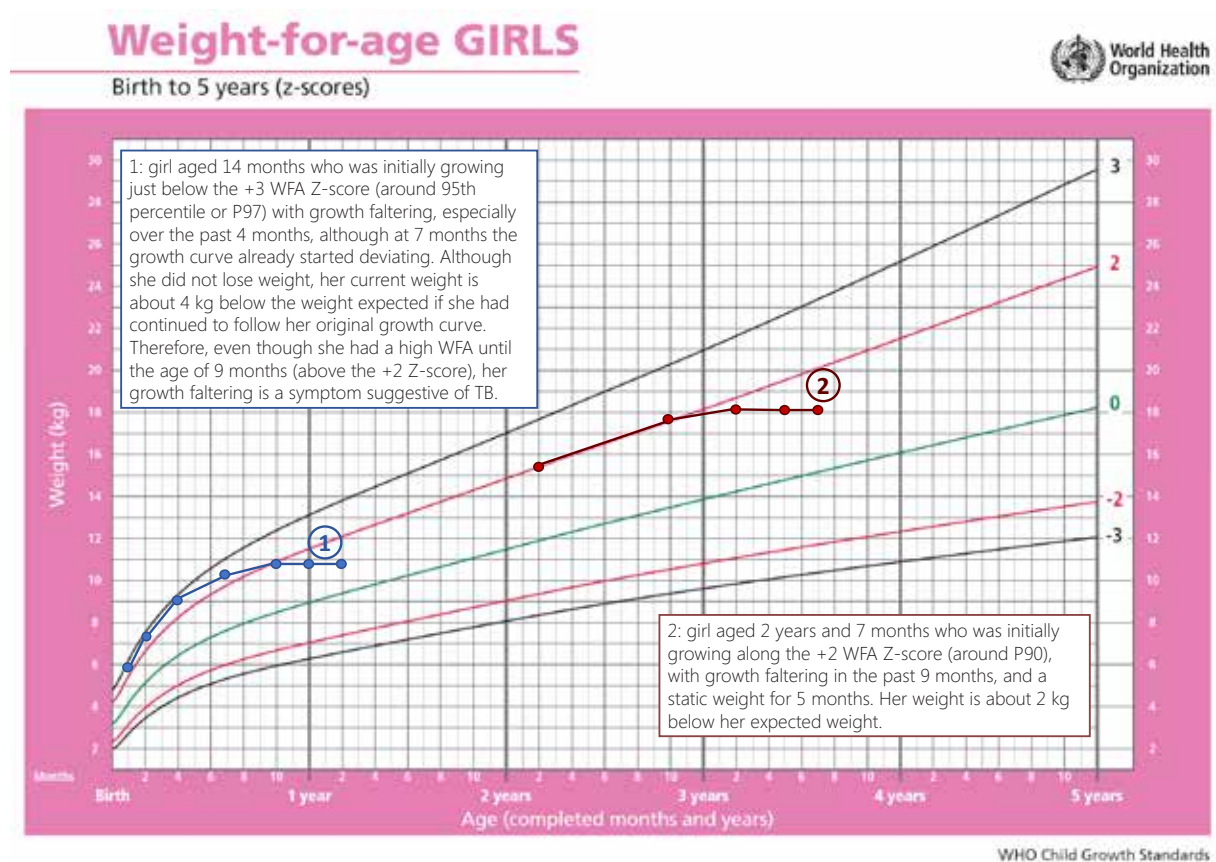

Weight-for-age BOYS

Birth to 5 years (z-scores)

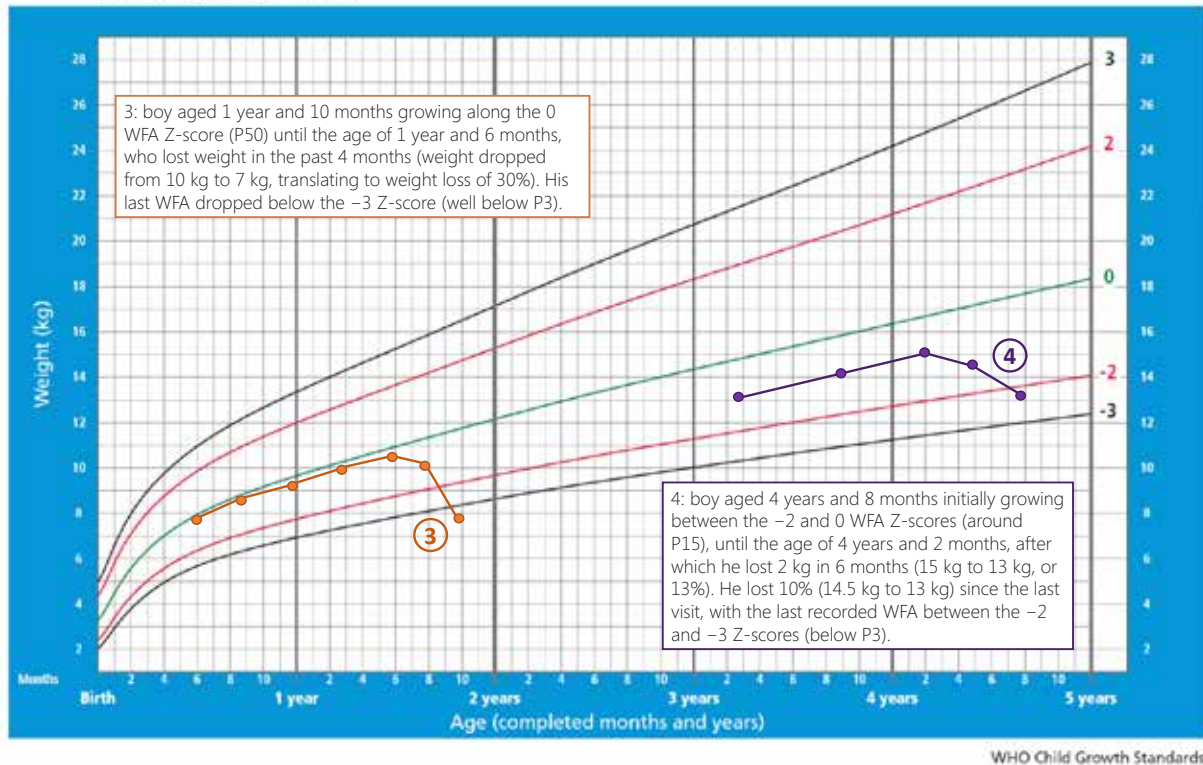

The trajectory in the past 3 months is the most important feature. A child growing along the same centile line over many years is not a concern for TB disease, even if this is more than 2 standard deviations below "normal".

Z-score -2: underweight for age; Z-score -3: very low WFA.

Source: Weight-for-age. Geneva: World Health Organization (<https://www.who.int/tools/child-growth-standards/standards/weight-for-age>).

4.3.4. Atypical clinical presentations of children with pulmonary TB

TB may present in atypical ways, such as acute severe pneumonia (more common in children aged under 2 years and children living with HIV) or fixed airway wheezing (more common in young children aged under 5 years) (72).

Signs of severe pneumonia include:

- peripheral oxygen saturation below 90% or central cyanosis;
- severe respiratory distress (e.g. grunting, nasal flaring, very severe chest indrawing);
- signs of pneumonia, defined as cough or difficulty in breathing with fast breathing (tachypnoea) or chest indrawing, with any of the following danger signs:
 - inability to breastfeed or drink;
 - persistent vomiting;
 - lethargy or reduced level of consciousness;
 - convulsions;
 - stridor in a calm child;
 - severe malnutrition.

PTB should be suspected if there is a poor response to antibiotics, and especially if there is a positive TB contact history. In children living with HIV, other HIV-related lung disease such as *Pneumocystis jirovecii* pneumonia (formerly known as *Pneumocystis carinii* pneumonia or PCP) should also be suspected.

Asymmetrical and persistent wheezing can be caused by airway compression due to enlarged intrathoracic TB lymph nodes. PTB should be suspected when a wheeze is asymmetrical, persistent and monophonic, not responsive to bronchodilator therapy, and associated with other typical features of TB (e.g. poor weight gain, persistent fever).

Weight loss or failure to thrive

Wheezing due to asthma is usually recurrent and variable rather than persistent, responsive to inhaled bronchodilators, and not associated with other typical features of TB.

4.3.5. Bacteriological confirmation

Despite challenges with bacteriological confirmation of paucibacillary TB in young children, every effort should be made to establish bacteriological confirmation. In adolescents, who usually have adult-type disease, bacteriological confirmation is common.

Bacteriological confirmation is even more important for children and adolescents who:

- have presumed DR-TB;
- are living with HIV;
- have complicated (e.g. airway obstruction, pneumothorax, empyema) or severe TB disease;
- have an uncertain diagnosis;
- have been treated previously.

4.3.5.1. Sample types

WHO-recommended clinical samples for the diagnosis of PTB in children and adolescents using Xpert MTB/RIF or Ultra include sputum (expectorated or induced), gastric or nasopharyngeal aspirates, and stool. Other mWRDs using respiratory samples have only been validated on sputum samples. Each of these specimen types has distinct advantages and disadvantages (Table 4.1). Annex 3 summarizes the types of respiratory and non-respiratory specimens. Standard operating procedures for the most common sample collection methods are given in Annex 4.

Older children and adolescents often have adult-type disease (which includes cavitation on CXR) that is positive on bacteriological testing. Sputum collection by spontaneous expectoration is possible in these age groups, usually from the age of about age 8 years but sometimes in younger children (6, 72).

The choice of specimen type depends on:

- acceptability for the child, parents, HCWs and other stakeholders;
- feasibility of collecting and preparing specimens in the local context;
- local test availability.

Table 4.1. WHO-approved respiratory samples for diagnosis of pulmonary TB

Sample type	Advantages	Disadvantages	Caregiver acceptability
Expectorated sputum	Low cost Non-invasive	Not feasible in young children	High
Induced sputum	Non-invasive (if followed by spontaneous expectoration)	Requires several pieces of equipment, electricity, hypertonic saline and trained personnel May require additional nasopharyngeal aspiration in young children Aerosolized transmission risk to HCWs and others	Moderate
Gastric aspirate	Feasible in young children	Invasive High level of discomfort Requires fasting Requires consumables and trained personnel	Low
Nasopharyngeal aspirate	Feasible in young children Less invasive than gastric aspirate	Invasive Requires equipment and trained personnel Aerosolized transmission risk to HCWs and others (lower than for induced sputum)	Moderate
Stool	Non-invasive	Requires additional laboratory processing, depending on processing method Must wait for bowel movement	High

Stool

Stool is a newly recommended specimen for the diagnosis of PTB in children using Xpert MTB/RIF or Ultra (3, 26). It can be used as an alternative specimen, especially in situations when it is challenging to obtain adequate respiratory specimens for the diagnosis of PTB, such as in younger children. Testing stool may be more acceptable and feasible in certain settings, as it is less invasive than gastric or nasopharyngeal aspiration (NPA).

Children with TB swallow sputum containing TB bacilli originating from the lungs, which then pass through the digestive tract, where they can be detected in stool samples. Stool is, therefore, regarded as a respiratory specimen for the diagnosis of TB.

Evidence suggests that sputum (induced or expectorated) and gastric aspirates provide the highest detection yield, but Xpert MTB/RIF (73) and Ultra (web Annex 4) testing of stool specimens yield similar diagnostic accuracy to testing of other respiratory specimens in children (Table 4.2), while having the

important advantage of being non-invasive. When using stool specimens, a pre-processing step is needed before inserting the specimen into the Xpert cartridge. Different stool processing methods such as optimized sucrose floatation and the Simple One-step (SOS) stool processing method have been developed for Xpert MTB/RIF and Ultra testing (see [Table 4.3](#)).

Table 4.2. Diagnostic accuracy of Xpert MTB/RIF and Ultra in paediatric specimen types against a microbiological reference standard^a

Specimen type (population)	Sensitivity	Specificity	Certainty of evidence
Xpert MTB/RIF			
Sputum	0.65	0.99	Moderate
Gastric aspirate	0.73	0.98	Very low (se) to low (sp)
NPA	0.46	1.00	Moderate (se) to high (sp)
Stool	0.61	0.98	Low (se) to moderate (sp)
Stool (HIV-positive)	0.70	0.98	Low (se) to high (sp)
Xpert Ultra			
Sputum	0.73	0.97	Low (se) to high (sp)
Gastric aspirate	0.64	0.95	Moderate
NPA	0.46	0.98	Very low (se) to low (sp)
Stool	0.53	0.98	Moderate

se: sensitivity; sp: specificity.

^a Microbiological reference standard: TB culture on respiratory samples.

Key point

Recommendations for the use of stool as a non-invasive specimen for bacteriological confirmation of PTB and rifampicin resistance in children are an important new development.

Table 4.3. Commonly used stool processing methods to detect TB using a molecular WHO rapid diagnostic test (see [web Annex 4](#))

Optimized sucrose floatation	Simple One-step stool (SOS)
0.5 g stool is emulsified in 10 mL Sheather's solution (56% sucrose in distilled water) using wooden sticks and manual shaking, followed by 30 minutes of sedimentation	0.8–1 g (formed) or 2 mL (liquid) stool is added directly into the Ultra Sample Reagent bottle
The supernatant (0.5 mL) is mixed with the Ultra Sample Reagent	After incubation and sedimentation, the supernatant is used for Xpert testing similar to sputum testing
The procedure has a moderate risk for generating aerosols and should be performed in a biosafety cabinet	The procedure has a low risk for generating aerosols and can be performed using the same precautions as for Xpert MTB/RIF or Ultra on sputum

Although both methods can be used for stool processing, preliminary data suggest that the SOS method is easiest to implement at lower-level laboratories and most cost-effective, while maintaining diagnostic accuracy (74) (see [web annex 4](#)).

The following additional resources on stool processing methods are available:

- Practical manual of processing stool samples for diagnosis of childhood TB (<https://www.who.int/publications/i/item/9789240042650>);
- KNCV SOS Stoolbox (<https://www.kncvtbc.org/en/sos-stoolbox/>);
- TB-Speed tools and resources (<https://www.tb-speed.com/resources/>).

Nasopharyngeal aspirate

NPA is a relatively simple procedure that is less invasive than gastric aspiration and has a lower risk of nosocomial transmission than sputum induction (75). It can be used in children who are unable to expectorate sputum spontaneously in settings where more invasive procedures are not feasible. The child needs to fast for 2 hours before the procedure. NPA involves suctioning the nasopharynx using a sterile catheter inserted in the child's nostril with a mucus trap or a suctioning device while the child is in a supine position.

Additional details and sample collection standard operating procedures can be found in [Annex 4](#).

Box 4.2 Experiences from the TB-Speed Decentralization and Pneumonia studies

Setting and methods The Unitaid-funded TB-Speed Decentralization study is an operational research study using a before and after cross-sectional design to assess the impact of decentralizing an innovative childhood TB diagnostic approach. It is implemented in Cambodia, Cameroon, Côte d'Ivoire, Mozambique, Sierra Leone and Uganda. The intervention is at two levels:

- At the patient care level, an innovative childhood TB diagnostic approach is implemented, including systematic TB screening, clinical evaluation, NPA and stool or sputum testing using Xpert MTB/RIF Ultra (Cepheid), and optimized CXR reading.
- At the health systems level, two distinct decentralization strategies are implemented at the district hospital level and the PHC level.

Two districts with one district hospital and four PHC clinics per participating country were randomly assigned to implement the district hospital or PHC clinic strategies. Feasibility (uptake), safety, tolerability and acceptability of Ultra testing on NPA samples in children with presumptive TB at the district level and in children aged under 5 years hospitalized with severe pneumonia were evaluated.

TB-Speed Pneumonia was a stepped-wedge cluster-randomized trial enrolling children aged under 5 years with WHO-defined severe pneumonia in 15 hospitals from 6 high and very high TB incidence countries (Cambodia, Cameroon, Côte d'Ivoire, Mozambique, Uganda, Zambia) to evaluate the impact on mortality of systematic TB detection. The intervention consisted of systematic Xpert Ultra testing on one NPA and one stool sample at hospital admission. Children were followed up for 12 weeks. The study assessed the feasibility (uptake) and yield of Ultra on stool samples in children with severe pneumonia. Social sciences research assistants conducted semistructured individual interviews with selected parents of children enrolled in the study ($N = 59$) and with all study nurses ($n = 63$) from the 15 hospitals to assess their experiences and perceptions of NPA collection.

Selected findings – feasibility and yield Of 1746 children enrolled in the decentralization study at the district level, 1648 (94.4%) had NPA attempted, including 1653 (94.7%) with successful collection of NPA; 1634 (93.6%) with NPA tested with Ultra; 1582 (90.6%) with a valid Ultra result; and 30 (1.7%) testing positive. Of the 1746 children, 1390 (79.6%) had stool samples collected, 1333 (76.3%) had stool tested with Ultra; 1228 (70.3%) had a valid Ultra result; and 16 (0.9%) tested positive.

There were 39 children with microbiologically diagnosed TB and 230 (13.2%) clinically diagnosed with TB. Yield of Ultra in children with a TB diagnosis was 16/269 (5.9%) for stool samples, 30/269 (11.2%) for NPA samples, and 39/269 (14.5%) for both samples.

Of 1170 children with severe pneumonia, 1148 (98%) children had NPA attempted, including 1141 (97.5%) with successful collection of NPA; 1131 (96.7%) with NPA tested with Ultra; 1120 (95.7%) with a valid Ultra result; and 21 (1.8%) testing positive. No severe adverse events related to NPA were reported. A total of 944 (80.7%) children had a stool sample collected, including 921 (78.7%) with stool tested with Ultra; 905 (77.4%) with a valid Ultra result; and 16 (1.4%) testing positive. Overall, 24 children (2.1%) had a positive Ultra on either NPA or stool samples. Additionally, 58 children (5.0%) were clinically diagnosed. Yield of Ultra in children diagnosed with TB was 24/82 (29.3%) for both samples.

Selected findings – acceptability Most parents across all countries felt that NPA was a painful and fearful procedure for their child with severe pneumonia. Despite this, all participants reported positive attitudes towards NPA, linked to the procedure aiming to improve child health. They trusted the nurses' skills, and that nurses were precise during the procedure and didactic about it. Parents did not always clearly understand the diagnostic role of NPA sample collection for TB diagnosis. Some parents perceived NPA as a procedure that helped to facilitate their child's breathing.

Nurses also perceived NPA as an unpleasant or painful procedure for children, which often required repeated aspiration. Almost all nurses reported that NPA required additional support from another colleague or parent to restrain the child. Overall, nurses were positive about NPA as it contributes to improving child health and probably contributes to reducing mortality. Most of the nurses believed that as the procedure is less invasive and quicker to perform, NPA sample collection could replace other sample collection methods such as gastric aspirate.

Conclusions

- Overall, NPA samples could be collected in 95% of children.
- Combining NPA and stool samples was highly feasible in children with presumptive TB at the district level, and contributed to microbiological confirmation in 14.4% (39/269) of children diagnosed with TB.
- Combined NPA and stool samples was safe, highly feasible in children with severe pneumonia, and contributed to microbiological confirmation in 30% (24/82) of children diagnosed with TB.
- NPA was perceived as unpleasant or painful, but overall perceptions of the acceptability of the procedure were positive.

Source: unpublished data from the TB-Speed project (<https://www.tb-speed.com/>)

Details on other specimen collection methods can be found in [Annex 4](#).

4.3.5.2. WHO-recommended rapid diagnostic tests

Depending on the availability, resources and capacity, appropriate specimens from suspected sites of involvement should be collected for rapid testing using mWRDs or culture, and histopathological examination should be done for children with EPTB whenever possible. WHO recommends that NTPs replace microscopy as the initial diagnostic test for TB with mWRDs, which can be used on various respiratory and non-respiratory specimens ([Table 4.4](#)) (76). [Box 4.3](#) summarizes WHO recommendations on the use of rapid diagnostic tests for TB detection.

Table 4.4. Summary of WHO-recommended rapid diagnostic tests and specimen types that can be used with them for diagnosis of TB in children and adolescents

Test	Acceptable specimen types	Rifampicin resistance detection
Xpert MTB/RIF	Sputum Gastric fluid NPA Stool Cerebrospinal fluid (CSF) Lymph node aspirate or biopsy Pleural fluid Peritoneal fluid Pericardial fluid Synovial fluid Urine Blood ^a	Yes
Xpert Ultra	Sputum Gastric fluid NPA Stool CSF Lymph node aspirate or biopsy	Yes
Truenat MTB and MTB Plus (Molbio Diagnostics, Goa, India)	Sputum	Yes
TB-LAMP	Sputum	No
LF-LAM	Urine ^b	No

^a Use of a blood specimen is recommended for people living with HIV with signs and symptoms of disseminated TB.

^b Use of urine is recommended for children and adolescents living with HIV (see specific recommendations in [Box 4.4](#)).

Box 4.3 WHO recommendations on use of rapid diagnostic tests in adults and children with signs and symptoms of pulmonary TB

Recommendations on Xpert MTB/RIF and Xpert Ultra as initial tests in adults and children with signs and symptoms of pulmonary TB

In children with signs and symptoms of pulmonary TB, Xpert Ultra should be used as the initial diagnostic test for TB and detection of rifampicin resistance on sputum, nasopharyngeal aspirate, gastric aspirate or stool, rather than smear microscopy/culture and phenotypic drug susceptibility testing (DST) (*updated strong recommendation, moderate certainty of evidence for test accuracy in stool and gastric aspirate; low certainty of evidence for test accuracy in sputum; very low certainty of evidence for test accuracy in nasopharyngeal aspirate*).

In children with signs and symptoms of pulmonary TB, Xpert MTB/RIF should be used as an initial diagnostic test for TB and rifampicin-resistance detection in sputum, gastric aspirate, nasopharyngeal aspirate and stool rather than smear microscopy/culture and phenotypic DST (*strong recommendation, moderate certainty for accuracy in sputum; low certainty of evidence for test accuracy in gastric aspirate, nasopharyngeal aspirate and stool*).

In adults ^a with signs and symptoms of pulmonary TB, Xpert MTB/RIF should be used as an initial diagnostic test for TB and rifampicin-resistance detection in sputum rather than smear microscopy/culture and phenotypic DST (*strong recommendation, high certainty of evidence for test accuracy; moderate certainty of evidence for patient-important outcomes*).

In adults ^a with signs and symptoms of pulmonary TB and without a prior history of TB (≤ 5 years) or with a remote history of TB treatment (> 5 years since end of treatment), Xpert Ultra should be used as an initial diagnostic test for TB and for rifampicin-resistance detection in sputum, rather than smear microscopy/culture and phenotypic DST (*strong recommendation, high certainty of evidence for test accuracy*).

In adults ^a with signs and symptoms of pulmonary TB and with a prior history of TB and an end of treatment within the past 5 years, Xpert Ultra may be used as an initial diagnostic test for TB and for rifampicin-resistance detection in sputum, rather than smear microscopy/culture and phenotypic DST (*conditional recommendation, low certainty of evidence for test accuracy*).

Truenat MTB, MTB Plus and Truenat MTB-RIF Dx in adults and children with signs and symptoms of pulmonary TB (specimen type: sputum)

In children and adults ^a with signs and symptoms of pulmonary TB, the Truenat MTB or MTB Plus may be used as an initial diagnostic test for TB rather than smear microscopy/culture (*conditional recommendation, moderate certainty of evidence for test accuracy*).

In children and adults ^a with signs and symptoms of pulmonary TB and a Truenat MTB or MTB Plus positive result, Truenat MTB-RIF Dx may be used as an initial test for rifampicin resistance rather than culture and phenotypic DST (*conditional recommendation, very low certainty of evidence for test accuracy*).

Moderate complexity automated nucleic acid amplification tests (NAATs) for detection of TB and resistance to rifampicin and isoniazid

In people with signs and symptoms of pulmonary TB, moderate complexity automated NAATs may be used on respiratory samples for the detection of pulmonary TB, and of rifampicin and isoniazid resistance, rather than culture and phenotypic DST (*conditional recommendation; moderate certainty of evidence for diagnostic accuracy*).

Loop-mediated isothermal amplification (TB-LAMP)^b

TB-LAMP may be used as a replacement test for sputum-smear microscopy for diagnosing pulmonary TB in adults with signs and symptoms consistent with TB (*conditional recommendation, very low certainty evidence*).

TB-LAMP may be used as a follow-on test to smear microscopy in adults with signs and symptoms consistent with pulmonary TB, especially when further testing of sputum smear-negative specimens is necessary (*conditional recommendation, very low certainty evidence*).

^a In these recommendations, adults include adolescents aged 15 years and over.

^b These recommendations are extrapolated to using TB-LAMP in children, based on the generalization of data from adults, while acknowledging the difficulties of collecting sputum specimens from children.

Source: WHO consolidated guidelines on tuberculosis. Module 3: diagnosis – rapid diagnostics for tuberculosis detection, 2021 update. Geneva: World Health Organization; 2021 (26).

4.3.5.3. Molecular WHO-recommended rapid diagnostic tests for TB

The Xpert MTB/RIF assay is a cartridge-based automated test that uses real-time polymerase chain reaction (PCR) on the GeneXpert® platform to identify *M. tuberculosis* complex and mutations associated with rifampicin resistance directly from sputum specimens in less than 2 hours (76).

The Xpert MTB/RIF Ultra assay uses the same GeneXpert platform and a new enhanced cartridge developed to improve the sensitivity and reliability of detection of *M. tuberculosis* complex and rifampicin resistance (76).

Trace results are common with the use of Xpert Ultra in all paediatric specimen types, reflecting the paucibacillary nature of TB disease in children. For children and people living with HIV being evaluated for PTB, and for people being evaluated for EPTB, the “*M. tuberculosis* complex detected trace” Ultra result is considered bacteriological confirmation of TB (76). This is an important implementation consideration, considering the risk of morbidity and mortality in these populations. Trace results have an indeterminate result for rifampicin resistance, and alternative specimens may need to be collected for Xpert Ultra processing in people with a high likelihood of drug resistance.

The Truenat MTB and MTB Plus assays use chip-based real-time micro-PCR for the semiquantitative detection of *M. tuberculosis* complex directly from sputum specimens and can report results in less than an hour. The assays use automated battery-operated devices to extract, amplify and detect specific genomic DNA loci. The assays are designed to be operated in peripheral laboratories with minimal infrastructure and minimally trained technicians. If the assay result is positive, an aliquot of extracted DNA is run on the Truenat MTB-RIF Dx assay to detect mutations associated with RIF resistance (76).

4.3.5.4. Antigen detection in a lateral flow format (biomarker-based detection)

The urine lateral flow lipoarabinomannan (LF-LAM) assay is an immunocapture assay based on the detection of the mycobacterial lipoarabinomannan antigen in urine. For specific populations, LF-LAM may be used together with other approved TB diagnostics tests and affords a distinct advantage as a point-of-care test. Although the assay lacks sensitivity, it can be used as a fast bedside rule-in test for people living with HIV, especially in urgent cases where a rapid TB diagnosis is critical for the person’s survival. The Alere Determine TB LAM Ag (Abbott, Chicago, United States) is currently the only commercially available urine lipoarabinomannan test endorsed by WHO (76).

Recommendations for the use of LF-LAM distinguish between inpatients and outpatients (see [Box 4.4](#)). The recommendations apply only to the use of Alere Determine TB LAM Ag because newer assays have not been adequately validated or used outside limited research settings.

Box 4.4 WHO recommendations on use of lateral flow lipoarabinomannan assays

In inpatient settings, WHO strongly recommends using LF-LAM to assist in the diagnosis of TB disease in adults (including adolescents) and children living with HIV:

- with signs and symptoms of TB (pulmonary and/or extrapulmonary) (*strong recommendation; moderate certainty in the evidence about the intervention effects*); or
- with advanced HIV disease ^a or who are seriously ill ^b (*strong recommendation; moderate certainty in the evidence about the intervention effects*); or
- irrespective of signs and symptoms of TB and with a CD4 cell count below 200 cells/mm³ (*strong recommendation; moderate certainty in the evidence about the intervention effects*).

In outpatient settings, WHO suggests using LF-LAM to assist in the diagnosis of TB disease in adults (including adolescents) and children living with HIV:

- with signs and symptoms of TB (pulmonary and/or extrapulmonary) or seriously ill ^b (*conditional recommendation; low certainty in the evidence about test accuracy*); or
- irrespective of signs and symptoms of TB and with a CD4 cell count of less than 100 cells/mm³ (*conditional recommendation; very low certainty in the evidence about test accuracy*).

In outpatient settings, WHO recommends **against** using LF-LAM to assist in the diagnosis of TB disease in children and adults (including adolescents) living with HIV:

- without assessing TB symptoms (*strong recommendation; very low certainty in the evidence about test accuracy*);
- without TB symptoms and unknown CD4 cell count, or without TB symptoms and CD4 cell count greater than or equal to 200 cells/mm³ (*strong recommendation; very low certainty in the evidence about test accuracy*); and
- without TB symptoms and with a CD4 cell count of 100–200 cells/mm³ (*conditional recommendation; very low certainty in the evidence about test accuracy*).

^a Advanced HIV disease:

- For adolescents and children aged 5 years or over: CD4 count of less than 200 cells/mm³ or WHO clinical stage 3 or 4 event at presentation for care.
- For children aged under 5 years: all should be considered to have advanced HIV at presentation.

^b "Seriously ill" is defined based on four danger signs: respiratory rate of more than 30/minute, temperature of more than 39 °C, heart rate of more than 120/minute and unable to walk unaided (76). A seriously ill child is defined as having any of the following danger signs: lethargy or unconsciousness; convulsions; unable to drink or breastfeed; and repeated vomiting. Other clinical conditions such as body temperature $\geq 39^{\circ}\text{C}$ and age-defined tachycardia and/or tachypnoea can be considered based on clinical judgement (77).

Source: WHO consolidated guidelines on tuberculosis. Module 3: diagnosis – rapid diagnostics for tuberculosis detection, 2021 update. Geneva: World Health Organization; 2021 (26).

Key points: management of children with negative mWRD results

- A negative mWRD result does not exclude TB in children.
- A child with high clinical suspicion for TB should be treated for TB even if a rapid test result is negative or the test is not available.

4.3.5.5. Repeat testing with molecular WHO-recommended rapid diagnostic tests

In children with signs and symptoms of PTB in settings with a pre-test probability of 5% or higher (prevalence of confirmed TB of 5% or above in this specific population), repeat testing with Xpert MTB/RIF or Ultra may be considered after an initial negative Xpert MTB/RIF or Ultra test if the clinician has a high index of suspicion that the child has TB, using any of the recommended specimen types.

Box 4.5 WHO recommendations on repeat testing with Xpert MTB/RIF and Ultra

In children with signs and symptoms of pulmonary TB in settings with pre-test probability below 5% and an Xpert MTB/RIF negative result on the initial test, repeat testing with Xpert MTB/RIF in sputum, gastric fluid, nasopharyngeal aspirate or stool specimens may not be used (*conditional recommendation, low certainty of evidence for test accuracy for sputum and very low for other specimen types*).

In children with signs and symptoms of pulmonary TB in settings with pre-test probability 5% or more and an Xpert MTB/RIF negative result on the initial test, repeat testing with Xpert MTB/RIF (for total of two tests) in sputum, gastric fluid, nasopharyngeal aspirate and stool specimens may be used (*conditional recommendation, low certainty of evidence for test accuracy for sputum and very low for other specimen types*).

In children with signs and symptoms of pulmonary TB in settings with pre-test probability below 5% and an Xpert Ultra negative result on the initial test, repeat testing with Xpert Ultra in sputum or nasopharyngeal aspirate specimens may not be used (*conditional recommendation, very low certainty of evidence for test accuracy*).

In children with signs and symptoms of pulmonary TB in settings with pre-test probability 5% or more and an Xpert Ultra negative result on the first initial test, one repeat Xpert Ultra test (for a total of two tests) in sputum and nasopharyngeal aspirate specimens may be used (*conditional recommendation, very low certainty of evidence for test accuracy*).

In adults ^a with signs and symptoms of pulmonary TB who have an Xpert Ultra trace positive result on the initial test, repeat testing with Xpert Ultra may not be used (*conditional recommendation, very low certainty of evidence for test accuracy*).

Note that Xpert Ultra trace results in adolescents will require follow-up, including reassessing clinical symptoms and information on prior history of TB. In the case of suspected rifampicin resistance, repeat testing may provide additional benefit for detection and an initial attempt to assess rifampicin resistance. For children and for people living with HIV who are being evaluated for pulmonary TB, and for people being evaluated for extrapulmonary TB, the “MTBC detected trace” Ultra result is considered as bacteriological confirmation of TB.

^a Adults and adolescents aged 15 years and over.

Source: WHO consolidated guidelines on tuberculosis. Module 3: diagnosis – rapid diagnostics for tuberculosis detection, 2021 update. Geneva: World Health Organization; 2021 (26).

4.3.6. Testing for TB infection

Testing for *M. tuberculosis* infection using TST or IGRA is useful to support a diagnosis of TB in children with suggestive clinical features who are sputum smear-negative or who cannot produce sputum. A positive test for TB infection indicates prior or current infection with *M. tuberculosis* and can be particularly useful in the absence of known TB exposure (no positive contact history), as it confirms the child has been infected at some point in time (6, 15).

TST is considered positive (indicating infection with *M. tuberculosis*) if:

- it is 10 mm or more in any child, irrespective of BCG immunization;
- it is 5 mm or more in a child living with HIV or a severely malnourished child.

Note that a positive TST or IGRA does not distinguish between TB infection and TB disease.

More details on testing for *M. tuberculosis* infection are included in Chapter 3 on prevention. [Annex 2](#) provides information on administering, reading and interpreting a TST. Commercial serodiagnostics should not be used in children with presumed pulmonary or EPTB, irrespective of their HIV status (6).

4.3.7. Role of chest X-ray

CXR remains an important tool in the diagnosis of TB in children, especially those with negative bacteriological tests or where bacteriological testing is not available or not feasible. Most children with PTB have radiographic changes suggestive of TB. If possible, anteroposterior and lateral films should be obtained in children aged under 5 years, and posteroanterior films in older children and adolescents.

Abnormalities on CXR suggestive of PTB include:

- enlarged perihilar or paratracheal lymph nodes;
- dense alveolar opacification in a child who is not acutely ill;
- miliary pattern of opacification;
- cavitation (more frequent in adolescents);
- pleural or pericardial effusion in a child or adolescent who is not acutely ill.

Adolescents with TB usually have radiographic changes similar to those seen in adults, with apical infiltrates with or without cavity formation or unilateral large pleural effusions being the most common forms of presentation. They may also develop perihilar lymphadenopathy and other manifestations seen more commonly in children. Good-quality CXRs (including a lateral view when possible) are essential for a thorough clinical evaluation and should be read by someone trained in paediatric CXR interpretation (6, 72). Data on the use of computer-aided detection software for automated CXR reading in children remain limited, and further research is needed to make recommendations.

CXR is an important tool to determine severity of disease in children. This is necessary to determine eligibility for the 4-month treatment regimen recommended for children and adolescents aged 3 months to 16 years with non-severe TB.

Children with a decision to start TB treatment based on the integrated decision algorithms described below who have not had CXR as part of their evaluation should ideally have CXR done if available in the health care facility or nearby. This is important to help rule out alternative diagnoses, assist TB diagnosis and determine TB treatment duration. CXR can also be used to evaluate treatment response and alternative diagnoses in children not responding to TB treatment.

Key points: CXR findings

- CXR findings in children with PTB are often nonspecific. A CXR alone cannot be used to determine the correct treatment for the child.
- CXR is useful to support the clinical diagnosis of PTB when TB is suspected and bacteriological testing is negative.

Resources on interpretation of paediatric chest X-ray

- Palmer M, Seddon JA, Goussard P, Schaaf HS. Diagnostic CXR atlas for tuberculosis in children: a guide to chest X-ray interpretation. Paris: International Union Against Tuberculosis and Lung Disease; 2022 (<https://theunion.org/technical-publications/diagnostic-cxr-atlas-for-tuberculosis-in-children>).
- TB-Speed Chest X-ray training: a simplified child CXR interpretation course developed by International Support for Pulmonology (SPI) and Technical Assistance for Management (TeAM) in collaboration with the Unitaid-funded TB-Speed CXR working group, which is intended for health care providers working at the peripheral level (district hospital and PHC) of high TB burden and resource limited countries (https://www.tb-speed.com/wp-content/uploads/2021/09/Chest_X-Ray_Training_Children_Tuberculosis_TB-Speed.pdf).

See also [Annex 1](#) for further resources.

4.3.8. HIV testing

Routine HIV testing should be offered to all children and adolescents completing evaluation for exposure to TB, with presumptive TB or diagnosed with TB. Early and accurate detection of HIV infection is important to support the integrated management of TB/HIV coinfection. All children and adolescents with HIV-associated TB are eligible for ART and co-trimoxazole prophylaxis (6, 78). The diagnosis of TB in children and adolescents living with HIV is often more challenging than in HIV-negative children, due to overlapping symptoms with HIV-associated infections and conditions (79).

[Section 7.1](#) provides more details on the management of TB/HIV coinfection in children and adolescents.

4.3.9. Integrated treatment decision algorithms for pulmonary TB in children

In children with presumptive PTB attending health care facilities, integrated treatment decision algorithms may be used to diagnose PTB. This is an interim conditional recommendation valid until 2024, after which new evidence will be reviewed (see [Box 4.6](#)).

New integrated treatment decision algorithms for specific populations and settings have been developed and internally validated, and are described in this section. The algorithms cover the diagnosis of PTB in children aged under 10 years, including those with intrathoracic lymphadenopathy. The algorithms are not suitable for the diagnosis of EPTB. The main motivation to develop evidence-based treatment decision algorithms was to decrease the large case detection gap and to improve treatment access for children in high TB incidence settings with limited resources, where TB diagnoses are frequently missed.

NTPs and other health programmes are encouraged to use the evidence-based algorithms presented in [Figures 4.4](#) and [4.5](#) rather than alternative algorithms that have not been evaluated.

Box 4.6 WHO interim recommendation on use of integrated treatment decision algorithms

In children with presumptive pulmonary TB attending health care facilities, integrated treatment decision algorithms may be used to diagnose pulmonary TB (*conditional recommendation, very low certainty of evidence*).

Notes:

- ➔ Presumptive TB refers to a person who presents with symptoms and/or signs suggestive of TB.
- ➔ Bacteriological confirmation should be sought as part of the integrated treatment decision algorithms whenever possible, using WHO-recommended rapid diagnostic tests on appropriate paediatric specimens (including stool, nasopharyngeal aspirate, induced or expectorated sputum or gastric aspirate).
- ➔ This interim recommendation will remain valid for a period of 24 months after the publication of these guidelines, after which new evidence will be reviewed.

New treatment decision algorithms for use in settings with and without CXR were developed based on diagnostic and treatment outcome data in children aged under 10 years presenting for evaluation of pulmonary TB in high TB burden settings. A brief description of the methodology is included in [Annex 5](#). The algorithms are shown in [Figures 4.4](#) and [4.5](#) and are included in Annex 5 as printable job aids.

The algorithms and guidance on their use are included as printable job aids in [Annex 5](#), which also includes information on the methodology for the development and internal validation.

4.3.9.1. Algorithm A (for settings with chest X-ray) and Algorithm B (for settings without chest X-ray)

Figure 4.4. Algorithm A

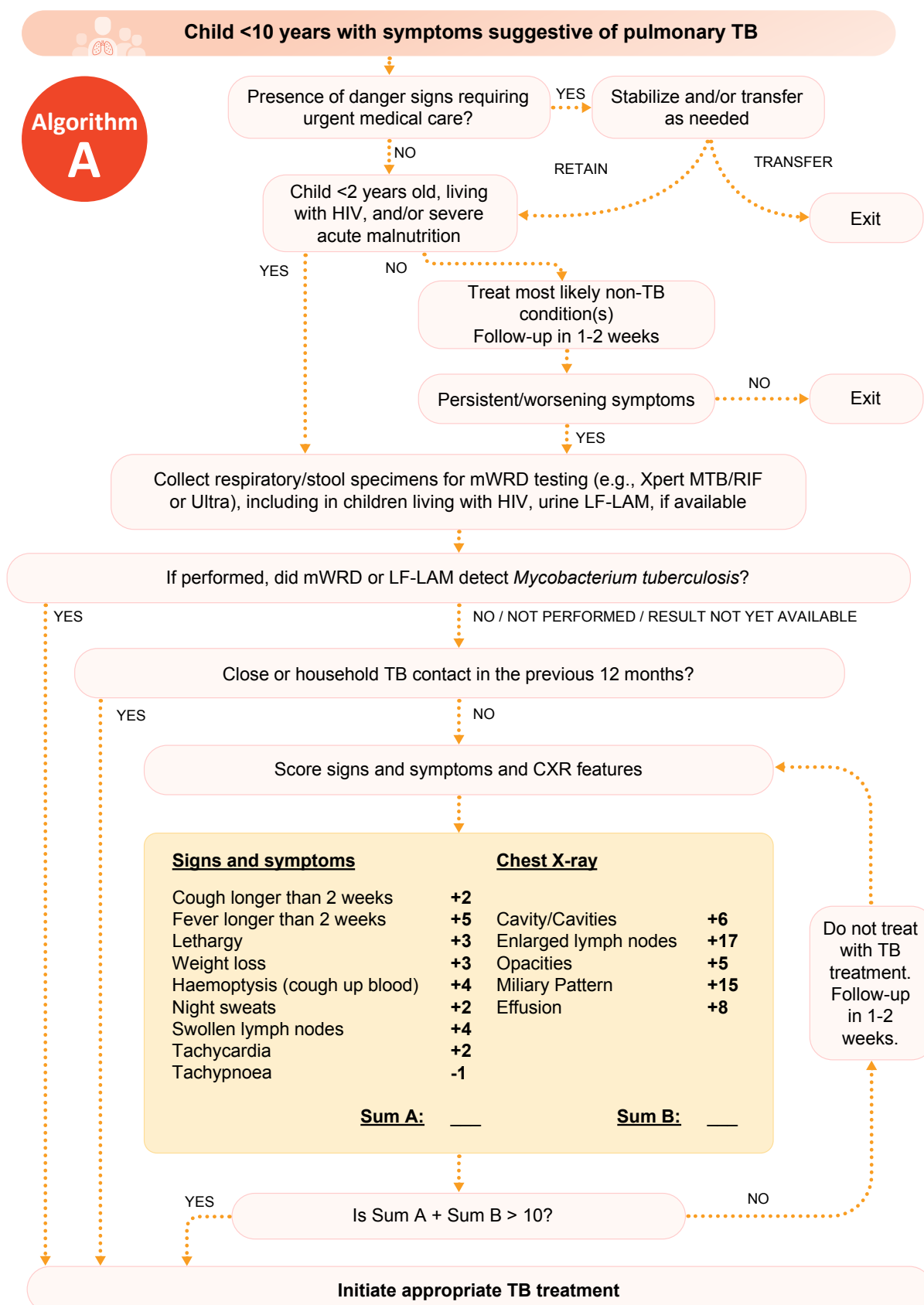
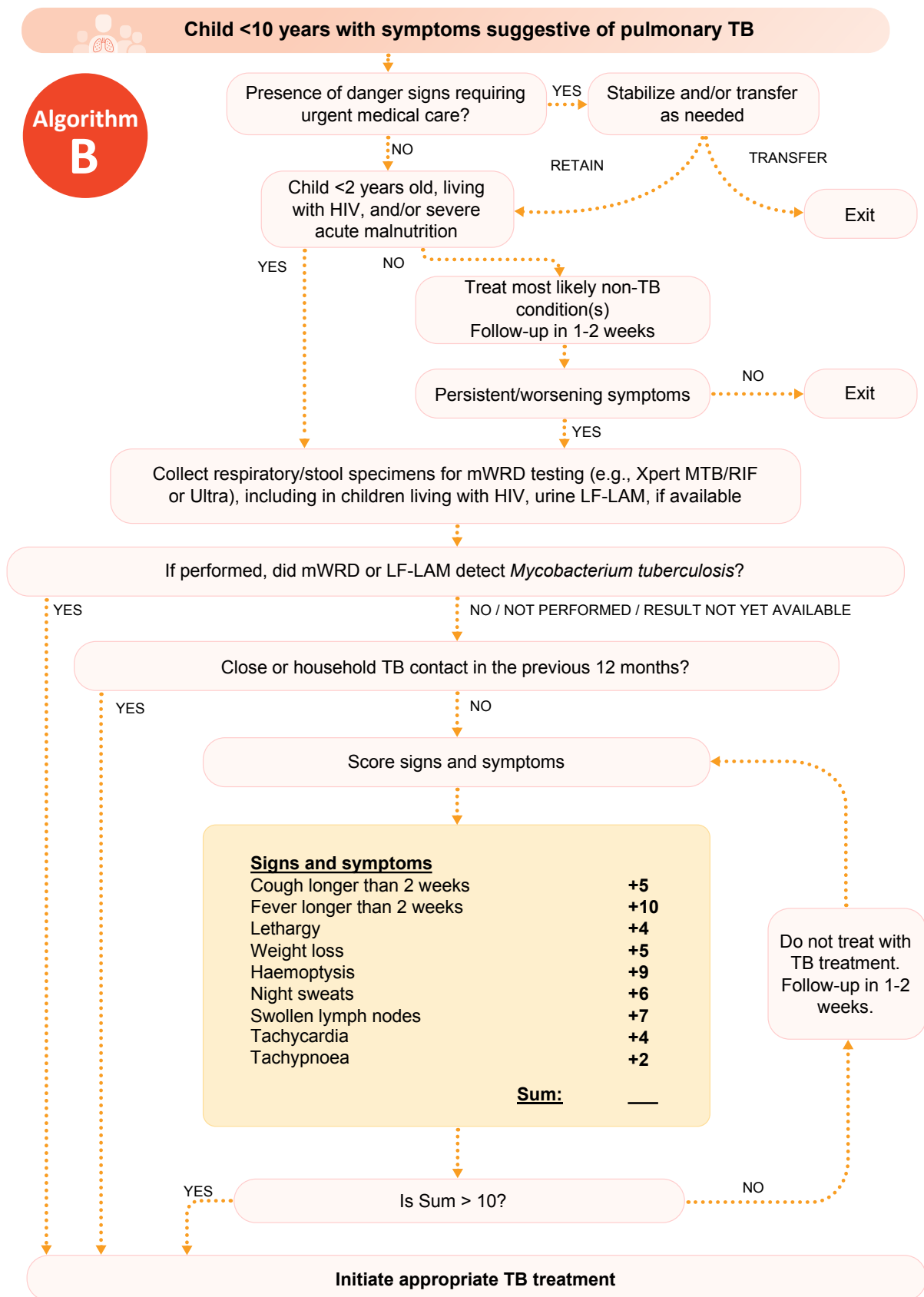

Figure 4.5. Algorithm B



4.3.9.2. Using the integrated treatment decision algorithms

Algorithms A and B have been developed to support health workers in the evaluation of children brought to health services due to parental or caregiver concern about their symptoms, or for child contacts who have screened positive (via symptoms or CXR screening) and been identified by HCWs as having presumptive TB. Children are classified as having presumptive TB if they have unremitting symptoms lasting more than 2 weeks (any one of cough, fever, not eating well or anorexia, weight loss or failure to thrive, fatigue, reduced playfulness or decreased activity). Definitions of symptoms can be found in [Box 4.7](#).

These algorithms are not intended to guide the management of children identified by active case-finding strategies or to evaluate asymptomatic children identified as being at high risk of TB or following exposure to a person with infectious TB (see Chapters 2 and 3 on screening and contact investigation and prevention).

Algorithm A can be used in contexts where CXR is available. Algorithm B can be used in contexts where CXR is not available.

The first step in both algorithms is to determine whether the child has signs and symptoms that indicate an urgent health problem. In children aged under 5 years, these signs and symptoms typically refer to “danger signs”, as defined by the IMCI approach (80). In older children, these signs and symptoms are defined in paediatric emergency triage, assessment and treatment (ETAT) (87). Important danger and priority signs are described in [Table 4.5](#).

Table 4.5. Danger and priority signs of severe illness or health problems in children aged under 10 years

Aged <5 years	Aged 5–9 years	All children aged <10 years
Danger signs (IMCI)	Danger signs (ETAT)	Priority signs
Gastrointestinal/circulatory: <ul style="list-style-type: none"> • Unable to eat or drink • Vomiting up everything • Signs of severe dehydration (sunken eyes, skin pinch returns very slowly) • Severe palmar pallor 	Gastrointestinal/circulatory: <ul style="list-style-type: none"> • Diarrhoea with any two signs of severe dehydration (lethargy, unconsciousness, sunken eyes, very slow return of skin after pinching) • Signs of shock (cold extremities with capillary refill time >3 seconds, weak and fast pulse) 	<ul style="list-style-type: none"> • Any sick child aged <2 months • High fever (>39° C) • Severe pallor • Respiratory distress • Restless, continuously irritable, lethargic • SAM
Respiratory: <ul style="list-style-type: none"> • Stridor • Oxygen saturation <90% 	Respiratory: <ul style="list-style-type: none"> • Obstructed or absent breathing • Severe respiratory distress • Central cyanosis 	
Neurological: <ul style="list-style-type: none"> • Seizures • Profoundly lethargic, unconscious • Neck stiffness or bulging fontanelle 	Neurological: <ul style="list-style-type: none"> • Coma (or seriously reduced level of consciousness) • Seizures 	

If any of these signs is present, the child should be stabilized and referred to a higher level of care as appropriate. Once stabilized, the child with presumptive TB should continue to be evaluated using Algorithm A or B. Children with presumptive TB are then stratified based on their risk of rapid TB disease progression:

- High-risk children include those aged under 2 years, living with HIV or with SAM (defined as weight-for-height Z-score less than -3 standard deviations or mid-upper arm circumference below 115 mm). For these high-risk children, a respiratory sample (expectorated or induced sputum, NPA sample, gastric aspirate or stool) should be collected for testing with mWRD (e.g. Xpert MTB/RIF or Xpert Ultra) if available. For children living with HIV, a urine specimen should be collected and sent for LF-LAM testing if available. If the Xpert or LF-LAM result is positive, TB treatment should be started. If Xpert or LF-LAM is not available, or if the result is negative, or if there will be a delay before receiving the results, high-risk children should enter the next step in either of the algorithms.
- Lower-risk children include those who do not have any of the high-risk characteristics (i.e. an HIV-negative child aged 2 years or older without SAM). These children should first be managed and treated for the most likely diagnosis based on the presenting signs and symptoms (e.g. asthma, pneumonia, pertussis, malaria). This would commonly include a course of broad-spectrum antibiotics and clinical review after 1–2 weeks. If the child has persistent or worsening symptoms when evaluated after 1–2 weeks, they should provide samples for testing with mWRD (e.g. Xpert MTB/RIF or Xpert Ultra). If Xpert is positive, TB treatment should be started. If Xpert is unavailable or negative or there will be a delay before receiving the result, the child should enter the next step in either of the algorithms.
- Children with unknown HIV status should be offered rapid HIV testing accompanied by pre- and post-test counselling in accordance with WHO recommendations for children with presumptive TB or TB exposure. This allows the child to be placed into the appropriate risk group to inform clinical management, as described above.

When evaluating a child using either of the algorithms, the following steps are implemented:

- While taking the clinical history, the health worker or clinician should identify whether the child has been exposed to a person with infectious (Xpert-, smear- or culture-positive) PTB in the past 12 months. This might include household exposure or close exposure to a person outside the home. If the child has been exposed to a person with infectious TB, the child should begin TB treatment immediately.
- If there is no identified TB exposure, the next step is to assess the features in the yellow part of the algorithm using information collected during the clinical history and physical examination of the child and CXR if available. When a feature is present, the corresponding score is noted, and the scores are added up:
 - Algorithm A is used when CXR is available. Scores from the signs and symptoms (left part of the yellow box) and the CXR (right part of the yellow box) are combined. The CXR can be done at any point during the evaluation (in parallel with or after scoring signs and symptoms from the clinical history and physical examination). The scores from the two parts of the yellow box are added. A decision to start treatment is made based on a score over 10. This may be achieved using only the left part of the yellow box (clinical history and physical examination score) while awaiting the CXR result, or with consideration of the CXR result once it is available. It is advisable to do a CXR as part of the evaluation as it is an important tool to determine severity of disease and may also support an alternative diagnosis.
 - Algorithm B is used when CXR is not available. It features only the signs and symptoms section based on clinical history and physical examination (yellow box). (Note that scores in this section are distinct from those in Algorithm A.) A decision to start treatment is made based on a score over 10.

- In either algorithm, if the child's total score is over 10, the child should start TB treatment using a WHO-recommended regimen.
- If the score is 10 or less, the child should not start TB treatment but should return in 1–2 weeks to undergo a repeat clinical history and physical examination.

Box 4.7 Example of scoring via Algorithm A

- If a child has a cough for more than 2 weeks (+2 points), lethargy (+3 points), tachycardia (+2 points) and none of the stated radiological features on CXR (cavities, enlarged lymph nodes, opacities, miliary pattern or effusions), the child is assigned 7 points and should not start TB treatment. The child should be treated for the most likely alternative diagnosis and reassessed in 1–2 weeks.
- If a child has weight loss (+3 points), swollen lymph nodes (+4 points) and opacities on CXR (+5 points), the child is assigned 12 points and should start TB treatment.

Box 4.8 Example of scoring via Algorithm B

- If a child has a cough for more than 2 weeks (+5 points), fever for 5 days (0 points as it is less than 2 weeks) and tachypnoea (+2 points), the child is assigned 7 points and should not start TB treatment. The child should be treated for the most likely alternative diagnosis and reassessed in 1–2 weeks.
- If a child has a cough for more than 2 weeks (+5 points), weight loss (+5 points) and swollen lymph nodes (+7 points), the child is assigned 17 points and should start TB treatment.

When a decision to treat for TB has been made, the HCW must complete two additional evaluations to inform the choice of treatment regimen:

- Assessment for risk factors for the child having DR-TB: DR-TB should be considered when there is:
 1. contact with a confirmed or presumed person with DR;
 2. a poor response to first-line treatment after 2–3 months; or
 3. previous TB treatment in the past 12 months (see [Section 4.6](#)).

Children with risk factors for DR-TB should be referred to the appropriate level of care as needed.

- Determination of whether the child has severe or non-severe disease to inform selection of treatment regimen: non-severe PTB is defined as intrathoracic lymph node TB without airway obstruction; and uncomplicated TB pleural effusion or paucibacillary, non-cavitary disease confined to one lobe of the lungs and without a miliary pattern (additional details regarding determination of severity of disease when CXR and Xpert are not available are included in [Section 5.2.4](#)). Children with non-severe, presumed drug-susceptible TB should receive a 4-month treatment regimen. (See [Chapter 5](#) for information on regimens for the treatment of drug-susceptible TB and DR-TB.)

All children with a decision to start TB treatment should be registered and notified to the NTP.

Box 4.9 Definitions of symptoms suggestive of pulmonary TB included in treatment decision algorithms

- Cough: persistent, unremitting cough for 2 weeks or more.
- Fever: persistent fever for 2 weeks or more (the score in the algorithm is based on the duration of fever as per the history rather than the actual temperature on examination).
- Lethargy: persistent unexplained lethargy or decrease in playfulness or activity reported by the parent or caregiver.
- Weight loss: more than 5% reduction in weight compared with the highest weight recorded in the past 3 months, or failure to thrive (clear deviation from previous growth trajectory, or documented crossing of percentile lines in the preceding 3 months, or WFA Z-score of -2 or less, or weight-for-height Z-score of -2 or less in the absence of information on previous or recent growth trajectory).
- Haemoptysis: expectoration of blood or blood-tinged sputum. This is a very rare symptom in children aged under 10 years and should be distinguished carefully from blood brought up by a child following a nosebleed.
- Night sweats: excessive night-time sweating that soaks the bed or clothes.
- Swollen lymph nodes: non-painful, enlarged cervical, submandibular or axillary lymph nodes.
- Tachycardia:
 - children aged under 2 months: heart rate over 160 beats/minute;
 - children aged 2–12 months: heart rate over 150 beats/minute;
 - children aged 12 months to 5 years: heart rate over 140 beats/minute;
 - children aged over 5 years: heart rate over 120 beats/minute.
- Tachypnoea:
 - children aged under 2 months: respiratory rate over 60/minute;
 - children aged 2–12 months: respiratory rate over 50/minute;
 - children aged 12 months to 5 years: respiratory rate over 40/minute;
 - children aged over 5 years: respiratory rate over 30/minute.

4.4. Diagnostic approaches: extrapulmonary TB

EPTB refers to any bacteriologically confirmed or clinically diagnosed case of TB involving organs other than the lungs (e.g. pleura, peripheral lymph nodes, abdomen, genitourinary tract, skin, joints and bones, meninges) (71). The classification of intrathoracic lymphadenopathy in children was updated following an expert consultation in September 2021 as PTB. EPTB is common in young children and in children and adolescents living with HIV. Since it is more difficult to diagnose, children with presumed EPTB, especially those who are very ill, should be urgently evaluated or referred for further evaluation and diagnostic workup (see [Table 4.6](#)). Symptoms of EPTB vary, depending on the site of disease. They are usually persistent and progressive and may be associated with weight loss, poor weight gain and fever.

Clinical assessment in all presumed cases of EPTB should consider:

- history of TB contact (as above);
- collection of appropriate specimens from an affected site (including CSF, lymph node aspirate, lymph node biopsy, pleural fluid, peritoneal fluid, pericardial fluid, synovial fluid or urine specimens) for confirmatory tests, including mWRDs (and histology where appropriate and available);
- collection of respiratory samples (stool, expectorated or induced sputum, gastric aspirate or NPA sample) to evaluate for PTB (as the child may have both PTB and EPTB);
- CXR and other imaging, depending on the affected site;
- HIV testing.

Box 4.10 WHO recommendations on use of Xpert MTB/RIF and Xpert Ultra as initial tests in adolescents and children with signs and symptoms of extrapulmonary TB

In adults ^a and children with signs and symptoms of TB meningitis, Xpert MTB/RIF or Xpert Ultra should be used in cerebrospinal fluid as an initial diagnostic test for TB meningitis rather than smear microscopy/culture (*strong recommendation, moderate certainty of evidence for test accuracy for Xpert MTB/RIF; low certainty of evidence for test accuracy for Xpert Ultra*). ^b

In adults ^a and children with signs and symptoms of extrapulmonary TB, Xpert MTB/RIF may be used in lymph node aspirate, lymph node biopsy, pleural fluid, peritoneal fluid, pericardial fluid, synovial fluid or urine specimens as the initial diagnostic test for respective form of extrapulmonary TB rather than smear microscopy/culture (*conditional recommendation, moderate certainty of evidence for test accuracy for pleural fluid; low certainty for lymph node aspirate, peritoneal fluid, synovial fluid, urine; very low certainty for pericardial fluid, lymph nodes biopsy*).

In adults ^a and children with signs and symptoms of extrapulmonary TB, Xpert Ultra may be used in lymph node aspirate and lymph node biopsy as the initial diagnostic test for lymph nodes TB rather than smear microscopy/culture (*conditional recommendation, low certainty of evidence*).

In adults ^a and children with signs and symptoms of extrapulmonary TB, Xpert MTB/RIF or Xpert Ultra should be used for rifampicin-resistance detection rather than culture and phenotypic DST (*strong recommendation, high certainty of evidence for test accuracy for Xpert MTB/RIF; low certainty of evidence for Xpert Ultra*).

In adults ^a and children with signs and symptoms of disseminated TB, Xpert MTB/RIF may be used in blood, as an initial diagnostic test for disseminated TB (*conditional recommendation, very low certainty of evidence for test accuracy*).

^a In these recommendations, adults include adolescents aged 15 years and over.

^b This recommendation applies to all people with signs and symptoms of TB meningitis. The recommendation in children with signs and symptoms of TB meningitis is based on very low certainty of evidence for test accuracy for Xpert MTB/RIF. No data were available on the accuracy of Xpert Ultra for TB meningitis in children.

Source: WHO consolidated guidelines on tuberculosis. Module 3: diagnosis – rapid diagnostics for tuberculosis detection, 2021 update. Geneva: World Health Organization; 2021 (26).

Table 4.6. Typical clinical features of extrapulmonary TB and suggested investigations

Site of EPTB	Typical clinical presentation	Investigations
Common forms of EPTB		
TB of lymph nodes (TB lymphadenopathy)	Asymmetrical, painless, non-tender lymph node enlargement (often >2 × 2 cm) for >1 month not responding to other treatment (e.g. antibiotics) With or without discharging sinus Most commonly cervical nodes ^a	CXR Ultrasound (if available) Fine-needle aspiration biopsy or excision biopsy with histology, Xpert MTB/RIF or Ultra, culture (if available) Respiratory specimens for Xpert MTB/RIF or Ultra
Pleural TB	Dullness on percussion and reduced breath sounds with or without pleuritic chest pain No acute illness	CXR Ultrasound (if available) TST/IGRA Pleural tap with biochemical analysis and cell counts, Xpert MTB/RIF or Ultra or culture (if available) ^{b,c} Respiratory specimens for Xpert MTB/RIF or Ultra
Usually children aged <5 years with disseminated disease and severely ill		
TBM	Subacute onset (>5 days) of headache, irritability or abnormal behaviour, vomiting (without diarrhoea), lethargy, reduced level of consciousness, convulsions, neck stiffness, bulging fontanelle, cranial nerve palsies	CXR Lumbar puncture with biochemical analysis and cell counts and Xpert MTB/RIF or Ultra (rather than culture initially) completed on CSF ^b Brain imaging (if available) Respiratory specimens for Xpert MTB/RIF or Ultra TST/IGRA
Miliary TB ^d	Nonspecific symptoms with persistent fever, lethargy and wasting	CXR (typical miliary pattern) Respiratory specimens for Xpert MTB/RIF or Ultra Lumbar puncture with biochemical analysis and cell counts and Xpert MTB/RIF or Ultra on CSF to exclude TBM ^b TST/IGRA

Site of EPTB	Typical clinical presentation	Investigations
Usually children aged ≥5 years		
Abdominal TB	Abdominal swelling with ascites or abdominal masses No acute illness	CXR Abdominal ultrasound Ascitic tap with biochemical analysis and cell counts, Xpert MTB/RIF, Xpert Ultra, or culture (if available) ^b Respiratory specimens for Xpert MTB/RIF or Ultra
Spinal TB	Deformity of spine, narrow-angle kyphosis (gibbus) May have lower-limb weakness, paralysis, or loss of bowel or bladder control	X-ray spine Fine-needle aspiration biopsy or excision biopsy with histology and Xpert MTB/RIF, Ultra or culture (if available)
Pericardial TB	Cardiac failure Distant or muffled heart sounds Apex beat difficult to palpate	CXR Cardiac ultrasound Pericardial tap with Xpert MTB/RIF, Xpert Ultra or culture (if available) ^b Respiratory specimens for Xpert MTB/RIF or Ultra
TB bone and joint	Limitation of movement and abnormal gait Unilateral joint effusion (usually knee or hip) Swelling at end of long bones or small hand bones (dactylitis)	Radiograph of joint or bone Joint tap or synovial biopsy, microscopy, Xpert MTB/RIF, Xpert Ultra or culture (if available) ^b Respiratory specimens for Xpert MTB/RIF or Ultra

^a If axillary node enlargement on same side as BCG vaccination, consider BCG disease.

^b Typical findings suggesting TB on effusions (straw-coloured fluid, exudate with high protein, white blood cells (typically predominance of lymphocytes) on microscopy, positive Xpert MTB/RIF, Xpert Ultra or culture) or CSF (high protein, low glucose, white blood cells (typically predominance of lymphocytes) on microscopy, positive Xpert MTB/RIF, Xpert Ultra or culture).

^c If pus in tap, consider empyema.

^d Miliary TB is classified as PTB but often involves extrapulmonary features that can occur anywhere in the body.

Source: adapted from Guidance for national tuberculosis programmes on the management of tuberculosis in children, second edition. Geneva: World Health Organization; 2014 (<https://apps.who.int/iris/rest/bitstreams/514493/retrieve>) (6); and The Union's desk guide for diagnosis and management of TB in children, third edition. Paris: International Union Against Tuberculosis and Lung Disease; 2016 (https://theunion.org/sites/default/files/2020-08/2016_Desk-guide_Africa_Web.pdf) (72).

4.5. Disease severity

In children and adolescents, severity of TB disease ranges from mild to severe. Children with non-severe, drug-susceptible TB are now eligible to receive a shortened 4-month treatment regimen. For consideration of a 4-month treatment regimen for non-severe, drug-susceptible PTB in children and young adolescents aged 3 months to 16 years, non-severe TB is defined based on the clinical presentation of disease as assessed through physical examination and CXR. All children who have a

decision to treat for PTB based on the treatment decision algorithms should be assessed for disease severity. This assessment should not delay treatment initiation, as disease severity will only impact on the duration of the continuation phase.

Non-severe TB is defined as peripheral lymph node TB; intrathoracic lymph node TB without airway obstruction; uncomplicated TB pleural effusion (without empyema or pneumothorax); or paucibacillary, non-cavitary disease confined to one lobe of the lungs and without a miliary pattern (evaluated on CXR). Severe disease in children and young adolescents is usually defined by the presence of cavities or bilateral disease on CXR (82).

More details regarding determination of severity of disease when CXR or Xpert MTB/RIF or Ultra is not available can be found in [Chapter 5](#) on treatment.

4.6. Diagnostic approaches: drug-resistant TB

The clinical presentation of DR-TB in a child or adolescent is similar to that of other forms of TB in a child or adolescent. When DR-TB is suspected, it is important to collect respiratory samples (stool, expectorated or induced sputum, NPA sample or gastric aspirate) for bacteriological confirmation by Xpert MTB/RIF or Xpert Ultra when possible. Truenat MTB or MTB Plus may also be used for sputum specimens. Xpert and Truenat assays provide rapid information that indicates rifampicin resistance and therefore DR-TB. Culture-based phenotypic DST, rapid, low-complexity automated nucleic acid amplification tests (NAATs) and LPAs allow testing for susceptibility to a wide range of medicines (see [Box 4.11](#)).

More details regarding diagnostic tests for detection of DR-TB are found in the *WHO operational handbook on tuberculosis. Module 3: diagnosis – rapid diagnostics for tuberculosis detection (76)* and *Module 4: treatment – drug-resistant TB treatment (82)*.

If there is known contact with a person with DR-TB, it is important to obtain the resistance pattern of the most likely source case to guide treatment (see [Section 5.3](#)). There is over 80% concordance between DST patterns in children with TB and the likely source case (83). If this information cannot be obtained, treatment should be started based on the most likely drug susceptibility pattern.

Key points:

DR-TB in a child or adolescent should be suspected when:

- there is contact with a person with confirmed DR-TB;
- there is contact with a person with presumed DR-TB (source case did not respond to treatment (failed treatment) or is currently retreated for TB or recently died from TB);
- a child or adolescent with TB is not responding to first-line treatment after 2–3 months despite good adherence (and IRIS is not considered likely in a child or adolescent living with HIV on ART);
- a child or adolescent previously treated for TB (especially within the past 12 months) presents with recurrence of disease (either a true relapse or reinfection).

In all children aged under 10 years in whom a decision to treat for TB has been made based on the treatment decision algorithms, an assessment needs to be made for risk factors of DR-TB.

A high index of suspicion is required in children in close contact with a person with confirmed DR-TB and in children who have not improved clinically after completion of the intensive phase of first-line treatment (no improvement in symptoms, failure to gain weight, or persistently positive smear or culture). If a child is in close contact with a person whose TB treatment has failed, is non-adherent to TB treatment or has died from TB, information regarding confirmation of DR-TB in this person should be obtained (6, 72, 84).

Box 4.11 WHO recommendations for low-complexity NAATs for detection of resistance to isoniazid and second-line TB medicines, first- and second-line LPAs, and high-complexity reverse hybridization-based NAATs for detection of pyrazinamide resistance

In people with bacteriologically confirmed pulmonary TB, low-complexity automated NAATs may be used on sputum for the initial detection of resistance to isoniazid and fluoroquinolones, rather than culture-based phenotypic DST (*conditional recommendation; moderate certainty of evidence for diagnostic accuracy*).

In people with bacteriologically confirmed pulmonary TB and resistance to rifampicin, low-complexity automated NAATs may be used on sputum for the initial detection of resistance to ethionamide, rather than DNA sequencing of the *inhA* promoter (*conditional recommendation; very low certainty of evidence for diagnostic accuracy*).

In people with bacteriologically confirmed pulmonary TB and resistance to rifampicin, low-complexity automated NAATs may be used on sputum for the initial detection of resistance to amikacin, rather than culture-based phenotypic DST (*conditional recommendation; low certainty of evidence for diagnostic accuracy*).

For people with a sputum smear-positive specimen or a cultured isolate of *M. tuberculosis* complex (MTBC), commercial molecular LPAs may be used as the initial test instead of phenotypic culture-based DST to detect resistance to rifampicin and isoniazid (*conditional recommendation, moderate certainty in the evidence for the test's accuracy*).

For people with confirmed MDR/RR-TB, second-line LPAs may be used as the initial test, instead of phenotypic culture-based DST, to detect resistance to fluoroquinolones (*conditional recommendation; moderate certainty in the evidence for test accuracy for direct testing of sputum specimens; low certainty in the evidence for test accuracy for indirect testing of M. tuberculosis cultures*).

For people with confirmed MDR/RR-TB, second-line LPAs may be used as the initial test, instead of phenotypic culture-based DST, to detect resistance to the second-line injectable drugs (*conditional recommendation; low certainty in the evidence for test accuracy for direct testing of sputum specimens; very low certainty in the evidence for test accuracy for indirect testing of M. tuberculosis cultures*).

In people with bacteriologically confirmed TB, high-complexity reverse hybridization-based NAATs may be used on *M. tuberculosis* culture isolates for detection of pyrazinamide resistance rather than culture-based phenotypic DST (*conditional recommendation, very low certainty of evidence for diagnostic accuracy*).

Source: WHO consolidated guidelines on tuberculosis. Module 3: diagnosis – rapid diagnostics for tuberculosis detection, 2021 update. Geneva: World Health Organization; 2021 (26).

Key messages

- NTPs should prioritize bacteriological testing for all children and adolescents presumed to have TB. Confirmation of TB improves diagnostic accuracy, increases clinician awareness and competency, and supports the detection of MDR/RR-TB.
- For young children, PTB is typically a paucibacillary disease. Although every effort should be made to confirm the diagnosis, in children with negative bacteriological tests or if bacteriological testing is not available or cannot be done, the diagnosis will often be based on clinical factors, especially the presence of signs and symptoms, determination of TB exposure and CXR (if available).
- TST and IGRA are tests for TB infection that can be used to confirm a child has been infected with TB. Although these tests do not distinguish between TB infection and TB disease and a negative test does not rule out TB, they may be helpful during diagnostic evaluation.
- Starting TB treatment should not be delayed in children, adolescents and other high-risk groups if bacteriological testing, CXR or TB infection tests are not available and the person has been clinically diagnosed as having TB.
- Important new strategies include the following:
 - recommendations for Xpert (MTB/RIF and Ultra) testing of stool as a respiratory sample in children: use of stool as a sample allows for broader access to bacteriological testing for TB as it is non-invasive for young children who struggle to expectorate. Xpert MTB/RIF and Ultra can be used on a variety of paediatric specimens (expectorated or induced sputum, NPA sample, gastric aspirate, CSF, fine-needle aspiration biopsies). The use of bacteriological testing in children should be encouraged and facilitated. The choice of specimen depends on acceptability by the child and the caregiver and by feasibility of implementation in the local context;
 - use of evidence-based treatment decision algorithms in children aged under 10 years;
 - determining the severity of TB disease in children and young adolescents is important to guide use of the new 4-month treatment regimen for non-severe TB.

5. Treatment of drug-susceptible and drug-resistant pulmonary and extrapulmonary TB in children and adolescents

5.1. Introduction

This chapter summarizes the treatment options available for children and adolescents to treat drug-susceptible TB and DR-TB and pulmonary and extrapulmonary forms of TB (including TBM), and considerations related to post-TB health. It includes operational guidance on various new treatment approaches, including a 4-month treatment regimen, and important implementation considerations such as availability of child-friendly formulations and access to all key medicines for the treatment of DR-TB.

Treatment outcomes for children completing TB treatment are generally excellent. The vast majority of deaths attributable to TB in children occur in those who do not receive treatment (85). The key to stopping the spread of TB in a community, including to children and adolescents, is to start effective TB treatment in people who are infectious as soon as possible and to prevent TB disease in people at high risk of developing TB.

Figure 5.1. Pathway through exposure, infection and disease covered in Chapter 5

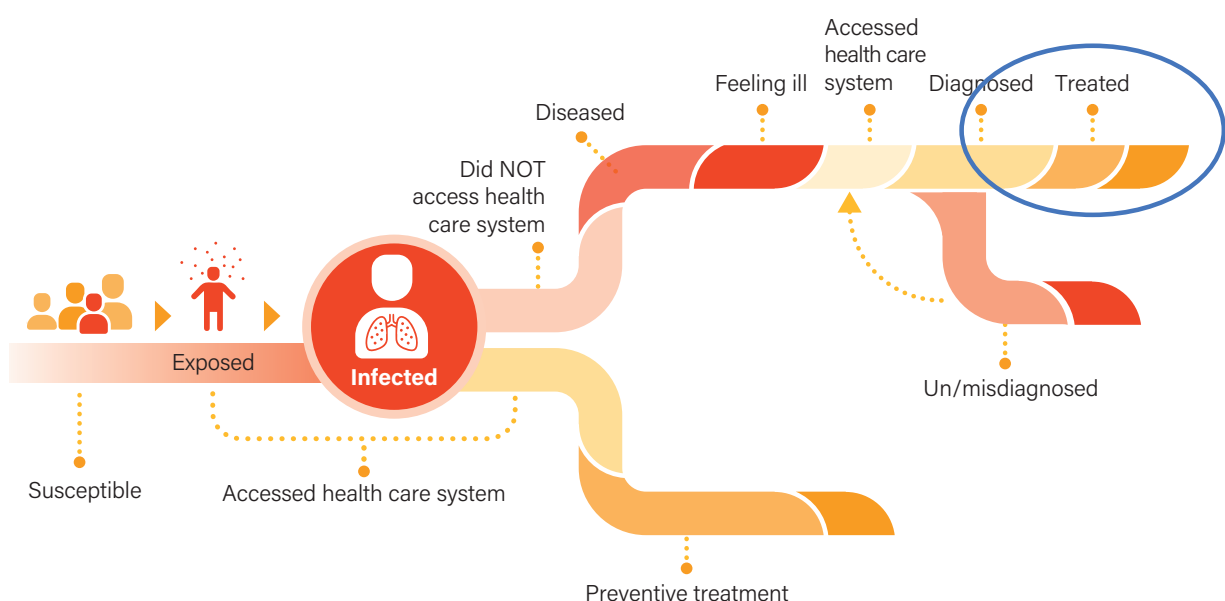

5.2. Treatment of drug-susceptible TB in children and adolescents

5.2.1. Principles of TB management

To achieve the goals of successful TB treatment in children and adolescents, clinical and programmatic management should include the following components and skills:

- management of TB medicines;
- recognizing clinical signs indicating the need for urgent care;
- managing comorbidities, including undernutrition;
- managing adverse events;
- implementing infection control practices;
- educating patients and their families and caregivers;
- providing psychological and socioeconomical support;
- involving family members in decisions regarding treatment;
- supporting treatment adherence;
- (reverse) contact investigation and providing TPT to other eligible family members;
- recording and reporting to monitor notifications and treatment outcomes;

Management of TB in children and adolescents should include contact investigation, considerations of infection control, nutritional evaluations, psychosocial support, and HIV assessment and care (Box 5.1).

Box 5.1 Measures to be taken when a child or adolescent is diagnosed with any form of TB

- Conduct contact or reverse contact (source patient) evaluation (see Chapter 2):
 - Who? Possible source patient(s) (e.g. parents and caregivers for children aged under 5 years; close (household) contacts for older children and adolescents with adult-type TB).
 - What? Evaluate.
 - Why? To find the source of infection for the child and protect other children in the home, or to identify the child's or adolescent's contacts and offer preventive treatment.
 - How? Evaluate by screening for TB symptoms and CXR if available. If screening is positive, evaluate for TB disease. If screening is negative in close contacts of older children, offer TPT.
- Implement infection control measures (see Chapter 3):
 - Who? Parents, caregivers and teachers.
 - What? Provide advice on how to prevent further transmission of infection in the home and at school, including the fact that children on effective treatment can resume school and social activities.
 - Why? To limit the spread of TB.
 - How? Improve natural ventilation, use separate sleeping arrangements for people who are infectious, and offer TPT if indicated.

- Conduct a nutritional assessment (see [Section 7.6](#)):
 - Who? Children and adolescents being evaluated or treated for TB.
 - What? Conduct nutritional assessment of the child or adolescent.
 - Why? Nutritional rehabilitation of children and adolescents who are malnourished because of TB or other comorbidities or undernourishment.
 - How? Provide advice to caregivers on appropriate diet. Provide nutritional supplements if necessary. Note the diagnosis of TB on the child's health card or other tool.
- Provide HIV care (see [Section 7.1](#)):
 - Who? Assess every child and adolescent with TB for HIV.
 - What? Provide appropriate testing or HIV care and treatment (e.g. early ART within 2 weeks of TB treatment initiation unless there are symptoms of TBM; co-trimoxazole prophylaxis).
 - Why? To reduce morbidity and mortality of TB/HIV coinfection in children and adolescents.
 - How? Ensure ART and TB drug interactions are managed.
- Provide social support, including educational, psychosocial and material support, to the child or adolescent and their caregivers.
 - Who? Every child, adolescent and family being treated for TB.
 - What? Provide psychosocial support. If possible, reassure the family that most children and adolescents with TB are successfully cured. Let caregivers know that the health care team is there to answer their questions.
 - Why? TB is associated with stigma and loss of income.
 - How? Provide resources if available for nutritional or financial support. Where possible, help the family avoid missed school and work, if applicable by inclusion in available social protection schemes.

5.2.2. Treatment of pulmonary TB in children and adolescents

Young children with TB usually have paucibacillary TB disease (TB disease forms with a lower burden of *M. tuberculosis* than is typical in adult-type cavitary TB disease) and are at lower risk for transmitting TB to other children or adults (6). School-aged children and adolescents, however, may have bacteriologically confirmed TB, sometimes with cavities on CXR (6).

All children diagnosed with TB disease (irrespective of bacteriological confirmation) should complete treatment with a full course of the appropriate TB regimen. Trials of TB treatment (using response to TB treatment as a diagnostic tool) are discouraged (72). Once initiated, the TB treatment regimen should be continued until completion, unless an alternative diagnosis has been established. High rates of cure and treatment completion can be achieved in children with TB (85).

A trial of treatment with TB medicines is not recommended as a method of diagnosing TB in children.

5.2.3. Recommended regimens for treatment of drug-susceptible pulmonary TB in children

As in adults, TB treatment in children and adolescents includes a 2-month intensive phase followed by a continuation phase of 2–4 months. In the intensive phase, TB bacilli are rapidly killed to prevent disease progression, transmission and development of drug resistance. In the continuation phase, dormant bacilli are eliminated to effect cure and prevent relapse. The choice of TB treatment regimen (including whether to include a fourth medicine – ethambutol – in the intensive phase) depends on the prevalence of HIV and isoniazid resistance in the setting, severity of disease and age.

In children and adolescents aged between 3 months and 16 years with non-severe TB, a 4-month treatment course is recommended. This recommendation is based on the Shorter Treatment for Minimal Tuberculosis in Children (SHINE) trial, a large phase III trial to evaluate duration of TB treatment in children with non-severe drug-susceptible TB. The trial showed that a 4-month treatment regimen (2 months of isoniazid, rifampicin, pyrazinamide with or without ethambutol, followed by 2 months of isoniazid and rifampicin, 2HRZ(E)/2HR) was non-inferior to the standard 6-month regimen (2 months of isoniazid, rifampicin, pyrazinamide with or without ethambutol, followed by 4 months of isoniazid and rifampicin, 2HRZ(E)/4HR) (86).

In adolescents aged 12 years and over, the 4-month isoniazid, rifapentine, pyrazinamide and moxifloxacin (HPZM) regimen may be used in all settings. This regimen (2HPZM/2HPM) met criteria for non-inferiority for cure of TB in bacteriologically confirmed participants when compared with 2HRZ(E)/4HR in a study that included 63 adolescents. Adverse events were similar in both groups (87).

WHO recommendations on the options to treat children for PTB, including intrathoracic lymph node TB, are summarized in [Box 5.2](#).

Box 5.2 Recommendations on treatment regimens for children and adolescents

In children and adolescents aged between 3 months and 16 years with non-severe TB (without suspicion or evidence of MDR/RR-TB), a 4-month treatment regimen (2HRZ(E)/2HR) should be used (*new: strong recommendation, moderate certainty of evidence*).

Remarks:

- ➔ Non-severe TB is defined as peripheral lymph node TB; intrathoracic lymph node TB without airway obstruction; uncomplicated TB pleural effusion or paucibacillary, non-cavitary disease confined to one lobe of the lungs and without a miliary pattern.
- ➔ Children and adolescents who do not meet the criteria for non-severe TB should receive the standard 6-month treatment regimen (2HRZE/4HR) or recommended treatment regimens for severe forms of extrapulmonary TB.
- ➔ The use of ethambutol in the first 2 months of treatment is recommended in settings with a high prevalence of HIV or of isoniazid resistance.

Children and adolescents with severe pulmonary TB disease should be treated with a four-medicine regimen (HRZE) for 2 months followed by a two-drug regimen (HR) for 4 months at standard dosages (*strong recommendation, moderate certainty of evidence*).

Infants aged 0–3 months with suspected or confirmed pulmonary TB or tuberculous peripheral lymphadenitis should be promptly treated with the 6-month treatment regimen (2HRZ(E)/4HR). Treatment may require dose adjustment to reconcile the effect of age and possible toxicity in young infants. The decision to adjust doses should be taken by a clinician experienced in managing paediatric TB (*strong recommendation, low certainty of evidence*).

Patients aged 12 years or older with drug-susceptible pulmonary TB may receive a 4-month regimen of isoniazid, rifapentine, moxifloxacin and pyrazinamide (2HPMZ/2HPM) (*new: conditional recommendation, moderate certainty evidence*).

Sources: WHO consolidated guidelines on tuberculosis. Module 5: management of tuberculosis in children and adolescents (3); WHO consolidated guidelines on tuberculosis. Module 4: Treatment – drug-susceptible tuberculosis treatment (87); Guidance for national tuberculosis programmes on the management of tuberculosis in children, second edition, 2014 (5).

Table 5.1 summarizes regimens for the treatment of PTB by age group, disease severity and local epidemiology.

Table 5.1. Pulmonary TB treatment regimens by age group, disease severity and local epidemiology

Age and severity of TB	Duration and composition of treatment regimen ^a	
	Intensive phase	Continuation phase
Infants aged <3 months or weighing <3 kg		
PTB of any severity	2HRZ or 2HRZE ^b	4HR
Children and adolescents aged 3 months to <12 years		
Non-severe PTB	2HRZ or 2HRZE ^b	2HR ^c
Severe PTB	2HRZE ^c	4HR
Adolescents aged 12–<16 years		
Non-severe PTB	2HRZ or 2HRZE ^b	2HR
Severe PTB	2HRZE ^d	4HR
PTB of any severity	2HPZM	2HPM
Adolescents aged 16–<20 years		
PTB of any severity	2HRZE ^e	4HR
PTB of any severity	2HPZM ^f	2HPM

^a The standard code for TB treatment regimens uses an abbreviation for each medicine: isoniazid (H), rifampicin (R), pyrazinamide (Z), ethambutol (E), rifapentine (P) and moxifloxacin (M). A regimen consists of two phases – the intensive and continuation phases. The number at the front of each phase represents the duration of that phase in months. For example, 2HRZE consists of treatment with isoniazid, rifampicin, pyrazinamide and ethambutol for 2 months.

^b In settings with a high HIV prevalence and/or a high isoniazid resistance prevalence, ethambutol should be added to the intensive phase of treatment. High HIV prevalence settings are defined as HIV prevalence $\geq 1\%$ among adult pregnant women or $\geq 5\%$ among people with TB. Thresholds for low, moderate or high levels of isoniazid resistance prevalence are established by country NTPs.

^c The SHINE trial was a non-inferiority trial that compared a 4-month regimen (2HRZ(E)/2HR) with a 6-month regimen (2HRZ(E)/4HR). The 4-month regimen was shown to be non-inferior. Therefore, the 6-month regimen may also be used for children with non-severe PTB if the 4-month regimen has not been adopted.

^d This regimen applies regardless of HIV prevalence and prevalence of isoniazid resistance.

^e This regimen applies to older adolescents regardless of disease severity, HIV prevalence and prevalence of isoniazid resistance.

^f This regimen applies to older adolescents regardless of disease severity, HIV prevalence and prevalence of isoniazid resistance, except for people weighing less than 40 kg and adolescents living with HIV with a CD4 count below 100 cells/mm³.

5.2.4. Implementation considerations

5.2.4.1. Assessing eligibility for the 4-month regimen

Non-severe TB is defined as peripheral lymph node TB, intrathoracic lymph node TB without airway obstruction, uncomplicated TB pleural effusion or paucibacillary, non-cavitary disease confined to one lobe of the lungs and without a miliary pattern.

As CXR is an important tool to assess severity of disease in children and adolescents, NTPs are encouraged to scale up access to good-quality CXR and provide training to health care providers in its interpretation. Out-of-pocket expenses for CXR pose a potential barrier to the diagnosis of TB and access to the shorter regimen for eligible children and young adolescents.

In the SHINE trial, children who were Xpert MTB/RIF-positive but sputum smear-negative were eligible for inclusion. The 85 children (7%) who were Xpert MTB/RIF-positive (45 in the 4-month arm, 40 in the 6-month arm) had very low or low semiquantitative Xpert MTB/RIF results (86). Therefore, in the eligibility criteria for the 4-month regimen, Xpert MTB/RIF or Ultra trace, very low or low semiquantitative results are included. If smear microscopy is used for bacteriological confirmation, the child should have a negative smear result to be eligible for the 4-month regimen.

Children with SAM, infants aged under 3 months, and children treated for TB in the past 2 years are not eligible for the 4-month regimen and should be treated with the 6-month regimen (see [Section 5.2.5](#)).

[Box 5.3](#) provides criteria for assessing severity of disease for different settings, including those without access to CXR and bacteriological testing.

Availability of medicines and child-friendly formulations are other important considerations when selecting a treatment regimen.

Box 5.3 Eligibility criteria for the 4-month regimen (2HRZ(E)/2HR) in children and adolescents aged between 3 months and 16 years with non-severe pulmonary or peripheral lymph node TB in various settings

In children and adolescents who have undergone bacteriological testing and CXR, a 4-month treatment regimen should be started in children and adolescents meeting all of the following three criteria:

- ➔ CXR findings consistent with non-severe TB (CXR should ideally be done at baseline, but it can be performed at any point during the treatment course):
 - intrathoracic lymph node TB without significant airway obstruction; or
 - PTB confined to one lobe with no cavities and no miliary pattern; or
 - uncomplicated pleural effusion (without pneumothorax or empyema);
- ➔ TB that is negative, trace, very low or low using Xpert MTB/RIF or Ultra, or sputum smear-negative (if Xpert MTB/RIF or Ultra not available);
- ➔ the child or adolescent has mild TB symptoms that do not require hospitalization. ^a

In settings without access to CXR, a 4-month treatment regimen should be implemented in children and adolescents meeting all of the following three criteria:

- ➔ TB that is negative, trace, very low or low by Xpert MTB/RIF or Ultra, or smear-negative;

- the child or adolescent has mild TB symptoms that do not require hospitalization; ^a
- TB symptoms resolved completely within 1 month of treatment initiation and the child is completely well, including a normal nutritional status, at 4 months of treatment.

In the absence of bacteriological testing and CXR, a 4-month treatment regimen may also be started in children and adolescents meeting any of the following two criteria:

- isolated extrathoracic (peripheral) lymph node TB, without involvement of other extrapulmonary sites of disease;
- the child or adolescent has mild TB symptoms that do not require hospitalization. ^a

^a Mild symptoms that do not require hospitalization means:

- none of the danger or high-priority signs listed in [Table 4.5](#);
- no asymmetrical and persistent wheezing;
- no signs of EPTB other than peripheral lymph node TB;
- none of the following: SAM, respiratory distress, high fever (over 39 °C), severe pallor, restlessness, irritability or lethargy.

Treatment should be continued for 6 months or modified in children and adolescents who have not responded clinically (demonstrating weight gain and/or resolution of TB symptoms) after 4 months of treatment. These people should be evaluated carefully for DR-TB, non-TB-related disease (e.g. malignancy or HIV-related lung disease) and poor treatment adherence.

5.2.4.2. Inclusion of ethambutol in the intensive phase of treatment

For many years, ethambutol was not recommended for use in children aged under 5 years. The concern was that it might cause optic neuritis in children who were too young to report the early visual symptoms, which could lead to irreversible blindness. A review of pharmacokinetic and safety data on ethambutol in children concluded that the risk of ocular toxicity was negligible if recommended dosages were adhered to, especially considering the fact that the use of ethambutol is limited to the intensive phase of treatment (88, 89).

In the SHINE trial, ethambutol was included in the first 2 months of treatment, depending on the local policy in place at the recruitment site for both the 4-month regimen and the comparator 6-month regimen. All children living with HIV in the SHINE trial received ethambutol in the first 2 months of treatment (regardless of the regimen they received).

It is preferred that children living with HIV who receive the 4-month regimen receive ethambutol for the first 2 months of treatment, irrespective of the background prevalence of HIV. In addition, it is strongly recommended that ethambutol be added to the 4-month regimen for the first 2 months in settings with a high background prevalence of isoniazid resistance or HIV infection.

5.2.4.3. Implementation considerations for the isoniazid, rifapentine, moxifloxacin and pyrazinamide regimen

The 4-month regimen including rifapentine and moxifloxacin (2HPMZ/2HPM) may be selected for adolescents aged 12 years and over and weighing at least 40 kg with PTB, regardless of disease severity (88). The following factors should be considered before selecting this regimen:

- The regimen should not be used in adolescents and children aged under 12 years.
- The regimen should not be used in adolescents with forms of EPTB, such as TBM, disseminated TB, osteoarticular TB or abdominal TB.

- The regimen is appropriate for people living with HIV, but it should not be used in people living with HIV with a CD4 count below 100 cells/mm³ or in people weighing less than 40 kg.
- The regimen should not be used in pregnant, postpartum or breastfeeding women.
- Although desirable, baseline DST for fluoroquinolones is not necessary if the person has been diagnosed using an mWRD that also tests for rifampicin resistance, as the prevalence of fluoroquinolone resistance is low in people with drug-susceptible TB.
- There is no FDC for this regimen. It represents a high pill burden and has a higher cost than the standard regimen. This should be discussed with the patient and their family when considering this regimen. There may also be limited availability of the individual medicines at many treatment sites. This situation may change in the future as uptake of the regimen improves, creating demand for it and its medicines.
- To ensure adequate exposures of rifapentine, the regimen should ideally be taken with a modest (not high) fat meal.

5.2.4.4. Dosing frequency

Daily dosing throughout treatment in the intensive and continuation phases is recommended for all treatment regimens for drug-susceptible TB in children.

Box 5.4 WHO recommendation on dosing frequency

In all patients with drug-susceptible pulmonary TB, the use of thrice-weekly ^a dosing is not recommended in both the intensive and continuation phases of therapy, and daily dosing remains the recommended dosing frequency (*conditional recommendation, very low certainty in the evidence*).

^a Three times a week.

Source: WHO consolidated guidelines on tuberculosis. Module 4: treatment – drug-susceptible tuberculosis treatment, 2022 update.

5.2.5. Subgroup considerations

5.2.5.1. Children with peripheral lymph node TB

Although the numbers of children with peripheral lymph node TB in the SHINE trial were small ($N = 19$ in the 16-week arm, $N = 21$ in the 24-week arm), there was no difference in the proportion of unfavourable outcomes between the two arms (86). These results may provide reassurance for clinicians regarding a seemingly delayed clinical response to TB treatment, frequently seen in children with peripheral lymph node TB (where lymph nodes remain enlarged even after treatment), even if these children are treated for 4 months.

5.2.5.2. Children and adolescents living with HIV

Children and young adolescents living with HIV were eligible for enrolment in the SHINE trial. A total of 65 children and adolescents living with HIV (11%) were enrolled in the 16-week arm and 62 (10%) in the 24-week arm. The 16-week regimen was non-inferior when compared with the 24-week regimen (risk difference -4.3 , 95% CI -14.9 to 6.2) (86).

Clinicians may consider treating children and adolescents living with HIV with non-severe TB for 4 months, depending on the degree of immunosuppression, ART status and presence of other opportunistic infections (90). These children and adolescents will need to be monitored closely, especially at 4 months of treatment, and treatment extended to 6 months if there is insufficient progress.

5.2.5.3. Children with severe acute malnutrition

No separate subgroup analysis could be conducted for children with SAM (defined as weight-for-height Z-score below -3 or mid-upper arm circumference below 115 mm (97)) in the SHINE trial due to the low numbers (30 children with SAM in the 16-week arm and 33 in the 24-week arm). As SAM is defined as a danger sign, even if children with SAM have a non-severe form of TB they should preferably receive 6 months of TB treatment.

5.2.5.4. Children with severe acute pneumonia

Children presenting with severe acute pneumonia who are diagnosed with TB should be treated for 6 months (2HRZE/4HR) in view of the severity of their symptoms, which, according to the definition of severe acute pneumonia, include cough or difficulty in breathing with at least one of the following:

- central cyanosis or oxygen saturation below 90% on pulse oximetry;
- severe respiratory distress (e.g. grunting, nasal flaring, very severe chest indrawing);
- signs of pneumonia with a general danger sign (inability to breastfeed or drink, persistent vomiting, lethargy or unconscious, convulsions, stridor in a calm child, severe malnutrition).

5.2.5.5. Infants aged under 3 months or weighing less than 3 kg

Infants aged under 3 months or weighing less than 3 kg (including premature birth (under 37 weeks) were not eligible for inclusion in the SHINE trial. No new data on treatment of congenital TB and very young infants aged 0–3 months with TB disease were received following a call for data. Given the early development of the immune system, infants aged under 3 months with suspected or confirmed PTB or tuberculous peripheral lymphadenitis should be treated promptly with the 6-month treatment regimen (2HRZ(E)/4HR), as per the existing recommendation from the 2014 *Guidance for national tuberculosis programmes on the management of tuberculosis in children* (6). Treatment may require dose adjustment to reconcile the effect of age and possible toxicity in young infants. The decision to adjust doses should be taken by a clinician experienced in managing paediatric TB.

5.2.5.6. Children and adolescents treated for TB in past 2 years

Given the increased risk of treatment failure and drug resistance, children and adolescents who had been treated in the preceding 2 years were not eligible for inclusion in the SHINE trial. These children should be treated with the 6-month treatment regimen (2HRZ(E)/4HR).

5.2.5.7. Children and young adolescents with severe pulmonary TB

Children and young adolescents with PTB who do not meet the eligibility criteria for the 4-month regimen should be treated with a standard 6-month regimen that includes a fourth drug – ethambutol – in the intensive phase (2HRZE/4HR).

5.2.6. Treatment of drug-susceptible extrapulmonary TB in children and adolescents

Children aged between 3 months and 16 years with EPTB limited to peripheral lymph nodes (i.e. without involvement of other sites of disease) should be treated with the shorter regimen (2HRZ(E)/2HR). Children with forms of drug-susceptible EPTB other than TBM and osteoarticular TB should be treated with a 6-month treatment regimen of 2HRZE/4HR. Children with osteoarticular TB should be treated with 2HRZE/10HR. Children with TBM should be treated with 2HRZE/10HR or the newly recommended alternative short intensive treatment regimen composed of 6 months of isoniazid, rifampicin, pyrazinamide and ethionamide (6HRZEto).

5.2.6.1. Treatment of TB meningitis and osteoarticular TB

Following infection with *M. tuberculosis*, young children are at high risk of developing the most severe forms of disease, of which the most devastating is TBM. This mainly affects young children (4). Up to 15% of childhood TB presents as TBM (92). With a decreasing incidence of bacterial meningitis attributed to other causes, TB is the leading cause of bacterial meningitis in many settings (93). TBM is associated with significant mortality and morbidity. In a systematic review and meta-analysis published in 2014, the risk of death for children aged 0–14 years with TBM was estimated at 19.3%, and the risk of neurological sequelae among survivors was estimated at 36.7% (94). Even in children without severe neurological sequelae, attention deficit and behavioural disorders are common following a diagnosis of TBM and the financial burden for families and society is high. A 6-month intensive treatment regimen has been used in South Africa since 1985, with relatively favourable outcomes observed (95, 96). No relapses were observed in a subset of patients followed up for 2 years after completing treatment (95).

For the 2022 consolidated guidelines, a systematic review and meta-analysis were conducted to compare the effectiveness of the short intensive treatment regimen used in South Africa versus the current WHO-recommended 12-month regimen (6). The standard 12-month regimen, consisting of isoniazid, rifampicin, ethambutol and pyrazinamide daily for the first 2 months followed by isoniazid and rifampicin daily for an additional 10 months (2HRZE/10HR) uses doses that are the same as those for the treatment of PTB (6, 97). The recommendation on the use of the 12-month regimen was based on a literature review (98) and was first included in *2010 rapid advice: treatment of tuberculosis in children* (97). The short intensive regimen is composed of daily isoniazid, rifampicin, pyrazinamide and ethionamide for 6 months throughout (6HRZEto), with higher mg/kg doses of isoniazid and rifampicin compared with the 12-month regimen (99). Ethionamide has good penetration of the blood–brain barrier (98). The 6HRZEto regimen had lower death rates and higher successful treatment rates but a higher proportion of neurological sequelae among survivors compared with the standard 12-month regimen.

The short intensive regimen is conditionally recommended as an alternative treatment option to the standard 12-month regimen (see Box 5.5). Further details can be found in the guidelines on the management of tuberculosis in children and adolescents (3).

Box 5.5 WHO recommendations on treatment of TB meningitis and osteoarticular TB in children and adolescents

Children with presumed or confirmed tuberculous meningitis should be treated with a four-drug regimen (HRZE) for 2 months, followed by a two-drug regimen (HR) for 10 months, the total duration of treatment being 12 months. The doses recommended for the treatment of tuberculous meningitis are the same as those described for pulmonary TB (*strong recommendation, low quality of evidence*).

In children and adolescents with bacteriologically confirmed or clinically diagnosed TB meningitis (without suspicion or evidence of MDR/RR-TB), a 6-month intensive regimen (6HRZEto) may be used as an alternative option to the 12-month regimen (2HRZE/10HR) (*new: conditional recommendation, very low certainty of evidence*).

Children with suspected or confirmed osteoarticular TB should be treated with a four-drug regimen (HRZE) for 2 months, followed by a two-drug regimen (HR) for 10 months, the total duration of treatment being 12 months (*strong recommendation, low certainty of evidence*).

Source: WHO consolidated guidelines on tuberculosis. Module 5: management of tuberculosis in children and adolescents. Geneva: World Health Organization; 2022 (3).

The treatment regimens for EPTB are summarized in [Table 5.2](#).

Table 5.2. Treatment regimens for extrapulmonary TB

Age and type of EPTB	Treatment regimen ^a	
	Intensive phase	Continuation phase
Infants aged <3 months or weighing <3 kg		
Peripheral lymph node TB	2HRZ or 2HRZE ^b	4HR
Children and adolescents aged 3 months–<16 years		
Peripheral lymph node TB	2HRZ or 2HRZE ^b	2HR
Adolescents aged >16 years		
Peripheral lymph node TB	2HRZ or 2HRZE ^b	4HR
Children and adolescents aged 0–19 years		
EPTB ^c	2HRZE	4HR
TBM ^d (strong recommendation)	2HRZE	10HR
TBM ^d (conditional recommendation)	6HRZEto	
Osteoarticular TB	2HRZE	10HR

^a The standard code for TB treatment regimens uses an abbreviation for each medicine: isoniazid (H), rifampicin (R), pyrazinamide (Z), ethambutol (E) and ethionamide (Eto). A regimen consists of two phases – the intensive and continuation phases (except for the 6HRZEto regimen). The number at the front of each phase represents the duration of that phase in months. For example, 2HRZE consists of treatment with isoniazid, rifampicin, pyrazinamide and ethambutol for 2 months.

^b High HIV prevalence settings are defined as HIV prevalence $\geq 1\%$ among adult pregnant women or $\geq 5\%$ among people with TB. Thresholds for low, moderate or high levels of isoniazid resistance prevalence are established by country NTPs.

^c This includes all forms of EPTB except peripheral lymph node TB, TBM and osteoarticular TB.

^d This includes all forms of TB involving the CNS.

5.2.6.2. Implementation considerations: treatment of TB meningitis

Children with TBM should preferably be hospitalized for initiation of treatment and close monitoring. Children aged under 2 years with miliary TB should be evaluated for TBM regardless of the presence of CNS symptoms. If these children are not evaluated for TBM for any reason, extension of treatment to 12 months may be considered.

The short intensive regimen is an option for children with bacteriologically confirmed or clinically diagnosed (probable) drug-susceptible TBM. The regimen is suitable for children and adolescents with no evidence of drug resistance and children and adolescents who have a low likelihood of drug resistant TB (e.g. those without risk factors for any form of DR-TB).

Data were limited on children and adolescents living with HIV treated with the short intensive regimen, and so the standard 12-month regimen should be used in children and adolescents living with HIV with TBM. In children and adolescents living with HIV, ART should be delayed at least 4 weeks (and initiated within 8 weeks) after treatment for TBM is initiated (see [Section 7.1](#)). In South Africa, where this regimen is used, children and adolescents living with HIV receive 9 months of HRZEto (with all medicines used throughout), but evidence was insufficient for assessment by WHO in 2021.

One key implementation consideration is administration of the short intensive regimen with the correct dosages of the included medicines, using currently available child-friendly and FDC formulations when possible. Historically, the regimen was dosed in South Africa using a child-friendly FDC of isoniazid and rifampicin (60 mg/60 mg) with pyrazinamide and ethionamide added as single medicines. An expert consultation on dosing convened by WHO in October 2021 considered the limited availability of this 60 mg/60 mg FDC globally, and the wide availability of an isoniazid/rifampicin (50 mg/75 mg) dispersible tablet, including through the Stop TB Partnership Global Drug Facility (GDF).¹⁶ An interim dosing strategy was developed based on the available child-friendly formulations for isoniazid/rifampicin, pyrazinamide and ethionamide after this consultation (see Table 5.6).

The feasibility of introducing the short intensive regimen is dependent on the setting. Acceptability, affordability and access to the component medicines (including the child-friendly ethionamide formulation) are important factors to consider. For the short intensive regimen, ethionamide should not be replaced with ethambutol if ethionamide is not available.

5.2.7. Recommended dosing of first-line medicines in children

5.2.7.1. Recommended dosages for first-line TB medicines

Table 5.3 shows the recommended dosages for first-line TB medicines for children. These dosages are applicable to all children, irrespective of the type of TB (except for TBM treated with the short intensive regimen) and HIV status. They also apply to the 12-month TBM regimen. Evidence on alternative compositions or dosages in the longer TBM regimen has not been assessed by WHO. For implications of interactions between ART and TB medicines, see Section 7.1 on TB/HIV coinfection.

Table 5.3. Recommended dosages of first-line TB medicines for use in children and young adolescents aged 0–14 years (excluding TB meningitis treated with alternative short intensive regimen)

Medicine	Dose (mg/kg body weight)	Range (mg/kg body weight)
Isoniazid (H)	10	7–15 ^a
Rifampicin (R)	15	10–20
Pyrazinamide (Z)	35	30–40
Ethambutol (E)	20	15–25

^a The higher end of the range for isoniazid applies to younger children. With older children, the lower end of the dosing range becomes more appropriate.

Table 5.4 shows the recommended dosages of TB medicines for children with TBM for the 6-month intensive regimen (6HRZEto). The short intensive TBM regimen uses higher doses per kilogram for isoniazid, rifampicin and pyrazinamide. Following on from the recommendation on the short intensive regimen for TBM, WHO convened an expert consultation in October 2021 to discuss how to administer the regimen, given the currently available child-friendly formulations. The experts judged that when using the available isoniazid and rifampicin (HR 50/75 mg) FDC in children, children would be exposed to a higher mg/kg dose of rifampicin (22.5–30 mg/kg), which was considered acceptable as part of the shorter TBM regimen. The dose of isoniazid should be maintained at 15–20 g/kg to avoid overexposure and associated potential toxicity.

¹⁶ GDF is a global provider of quality-assured TB medicines, diagnostics and laboratory supplies to the public sector, operating under the Stop TB Partnership Operational Strategy (<http://www.stoptb.org/gdf/>).

Table 5.4. Recommended interim dosing for the 6-month intensive regimen (6HRZEto) to treat drug-susceptible TB meningitis in children and adolescents

Medicine	Recommended dose range in the interim dosing strategy (mg/kg body weight)
Isoniazid (H)	15–20 ^a
Rifampicin (R)	22.5–30
Pyrazinamide (Z)	35–45
Ethionamide (Eto)	17.5–22.5

^a The higher end of the range for isoniazid applies to younger children. With older children, the lower end of the dosing range becomes more appropriate.

5.2.7.2. Dosage tables and formulations for treatment of drug-susceptible TB in children and adolescents

The use of FDC child-friendly tablets is recommended instead of separate formulations in the treatment of children with drug-susceptible TB (100). FDC tablets have advantages over single medicines as they reduce the pill burden and the likelihood of prescription errors. By reducing selective non-adherence, FDC tablets can reduce the risk of development of drug resistance.

Box 5.6 WHO recommendation on use of fixed-dose combination tablets

The use of fixed-dose combination (FDC) tablets is recommended over separate drug formulations in treatment of patients with drug-susceptible TB (*conditional recommendation, low certainty in the evidence*).

Source: WHO consolidated guidelines on tuberculosis. Module 5: management of tuberculosis in children and adolescents. Geneva: World Health Organization; 2022 (3).

Dispersible child-friendly FDC formulations for first-line TB medicines have been available since 2015. They can be dispersed in water to achieve an appropriate dose offering the opportunity to simplify and improve treatment (88, 100, 101). Child-friendly FDCs are WHO-prequalified. They are not new medicines but are improved formulations of medicines recommended and used for first-line treatment of TB.

Box 5.7 Currently available water-dispersible formulations for treatment of drug-susceptible TB

For the intensive phase of TB treatment:

- ➔ isoniazid 50 mg + rifampicin 75 mg + pyrazinamide 150 mg (HRZ 50/75/150 mg);
- ➔ a dispersible formulation of ethambutol (E 100 mg) is also available.

For the continuation phase of TB treatment:

- ➔ isoniazid 50 mg + rifampicin 75 mg (HR 50/75 mg). ^a

^a This formulation is also used for the 3RH TPT regimen (see Chapter 3).

Table 5.5 shows the recommended dosages by weight band (except for the short intensive TBM regimen). Note that dosages should be adjusted based on weight changes during TB treatment (see Section 5.2.12).

Table 5.5. Dosing table for first-line medicines (excluding the short intensive TBM regimen)

Weight (kg)	Number of tablets ^a		
	Intensive phase: HRZ 50/75/150 mg	E 100 mg ^b	Continuation phase: HR 50/75 mg
4–<8	1	1	1
8–<12	2	2	2
12–<16	3	3	3
16–<25	4	4	4
≥25	Adult dosages recommended		

Presentation of weight bands has been updated – for example, the 4–7 kg weight band is now written as 4–<8 kg. A child weighing 7.9 kg is dosed as per the 4–<8 kg weight band, a child weighing 8 kg is dosed as per the 8–<12 kg weight band.

^a Ideally, tablets should be dissolved in 50 mL water. The child should consume the complete fluid within 10 minutes of dissolving the tablets. If the child cannot consume the full amount, the tablets can be dissolved in a smaller amount of liquid.

^b Ethambutol (preferably using a dispersible tablet) should be added in the intensive phase for children with extensive disease, or if living with HIV, or if living in a setting where the prevalence of HIV or of isoniazid resistance is high.

5.2.7.3. Dosing table for the short intensive TB meningitis regimen

The recommended dosages by weight band for the 6-month intensive regimen (6HRZEto) to treat bacteriologically confirmed or clinically diagnosed TBM (without suspicion or evidence of MDR/RR-TB) in children and adolescents weighing less than 35 kg are shown in Table 5.6. These dosages were developed to limit formulation manipulation (splitting tablets), top-up with standalone medicines, number of weight bands and pill burden.

For children weighing less than 25 kg, it is preferable to use child-friendly dispersible tablet formulations, including the HR FDC. For children weighing 3–<5 kg, a joint age- and weight-based approach was adopted, accounting for maturation factors. The dosing of pyrazinamide and isoniazid and rifampicin for children weighing 3–<5 kg depends on whether the child is aged under or over 3 months.

For children weighing 25–<35 kg, either dispersible tablets or adult formulations of the corresponding medicines (HR 75/150 mg, Z 400 mg or 500 mg, Eto 250 mg) can be used. Using adult formulations in older children reduces the number of pills. For severely ill children, such as those with a reduced level of consciousness, child-friendly dispersible formulations can be administered via a nasogastric tube. Table 5.6 also provides dosing options for both Z 400 mg and Z 500 mg, acknowledging that NTPs may procure either formulation.

Ethionamide can cause hepatotoxicity, gastrointestinal irritability and hypothyroidism. Gastrointestinal irritability can mostly be overcome by dosing ethionamide in the evening, separately from other TB medicines.

Table 5.6. Dosing table: Short intensive TB meningitis regimen (6HRZEto)

Weight band (kg)	Weight 3–<35 kg using child-friendly formulations ^a				Weight 25–<35 kg using adult formulations (with Z 400 mg tablet) ^a				Weight 25–<35 kg using adult formulations (with Z 500 mg tablet) ^a		
	HR 50/75 mg dispersible tablet ^b	Z 150 mg dispersible tablet ^b	Eto 125 mg dispersible tablet ^b	HR 75/150 mg tablet	Z 400 mg tablet	Eto 250 mg tablet	HR 75/150 mg tablet	Z 500 mg tablet	Eto 250 mg tablet		
3–<4 ^c	<3 months 1.5 ^b	≥3 months 1.5 ^b	<3 months 0.5 ^b	≥3 months 1	<3 months 0.5 ^b						
4–<5 ^c	<3 months 1.5 ^b	≥3 months 2	<3 months 0.5 ^b	≥3 months 1	<3 months 0.5 ^b						
5–<6		2.5		1.5 ^b		1					
6–<8		3		2		1					
8–<10		3.5 ^b		2.5 ^b		1.5 ^b					
10–<13		4		3		2					
13–<16		5		3.5 ^b		2					
16–<20		6		4		2.5 ^b					
20–<25		7		5		3					
25–<30		9		6		4		2	2	4	2
30–<32		10		6		4		2	2	5	2
32–<35		10		6		4		3	2	5	2

^a For children weighing 25–<35 kg, adult formulations can be used to reduce the pill burden.

^b If the formulation has a scoring line, tablets can be split and administered whole or dispersed in water. If the formulation does not have a scoring line, tablets should be dispersed in a specific amount of water and the exact dose administered using an aliquot with a syringe. To give 0.5 tablet, dissolve 1 tablet in 10 mL water and administer 5 mL.

^c For children weighing 3–<5 kg, a joint age- and weight-based approach is used. The dosing of RH and Z for children weighing 3–<5 kg depends on whether the child is aged under or over 3 months. For example, an infant weighing 4.5 kg would receive 1.5 tablets of HR 50/75 mg and 0.5 tablets of Z 150 mg if aged under 3 months, but 2 tablets of HR and 1 tablet of Z if aged 3 months or over.

5.2.7.4. Dosing of first-line medicines in older children and adolescents over 25 kg (excluding the short intensive TB meningitis regimen)

For children and adolescents weighing 25 kg or over, adult guidance and dose recommendations should be followed. These children and adolescents can be treated with adult formulations.

Adolescents face unique challenges due to peer pressure, stigma, comorbidities such as HIV, and behaviours that can complicate treatment such as use of alcohol, tobacco and other substances. Adolescents aged 10–19 years require access to adolescent-friendly services that include relevant psychosocial support and minimal disruption of education (5). Section 7.4 provides more details on the approach to adolescents at risk of or with TB.

Table 5.7 gives the recommended dosages by weight band using adult FDCs. This table applies to children and adolescents aged under 16 years and weighing 25 kg or over who are being treated with the 4-month 2HRZ(E)/2HR regimen, and to children and adolescents weighing over 25 kg who are being treated with the 6-month 2HRZE/4HR regimen.

Table 5.7. Recommended dosage by weight for children and adolescents weighing over 25 kg using adult fixed-dose combinations (excluding the short intensive TB meningitis regimen)

Weight band (kg)	Intensive phase	
	HRZE 75/150/400/275 mg	HR 75/150 mg
25–<30 ^a	2	2
30–<35	3	3
35–<50	4	4
50–<65	4	4
≥65	5	5

^a Dosages based on expert opinion.

Adolescents aged 12 years and over who are treated with the 4-month HPZM regimen should receive the dosages shown in Table 5.8 (87).

Table 5.8. Recommended dosage by weight for adolescents being treated with the 4-month HPZM regimen

Weight band (kg)	4-month 2HPMZ/2HPM regimen			
	Intensive and continuation phase			Intensive phase only
	Isoniazid (H)	Rifapentine (P)	Moxifloxacin (M)	Pyrazinamide (Z)
40–<50	300 mg	1200 mg	400 mg	1500–1600 mg ^a
50–<65				1500–1600 mg ^a
≥65				2000 mg

^a Dose depends on use of Z 400 mg or 500 mg tablets.

5.2.7.5. Pyridoxine supplementation

Pyridoxine (vitamin B6) supplementation is recommended in children and adolescents living with HIV and in malnourished children and adolescents who are treated for TB, at a dosage of 0.5–1 mg/kg/day. Children weighing up to 25 kg receive half a 25 mg tablet or quarter of a 50 mg tablet (6). Supplementation with pyridoxine aims to prevent symptomatic pyridoxine deficiency, which presents as peripheral neuropathy, especially in children with severe malnutrition and children living with HIV. Pyridoxine dosages may be increased to 2–5 mg/kg/day if peripheral neuropathy develops, characterized by pain, burning or tingling in the hands or feet, numbness or loss of sensation in the arms and legs, or muscle cramps or muscle twitching.

5.2.8. Additional management considerations

5.2.8.1. Indications for referral and hospitalization

All children and adolescents with severe forms of TB (TBM, peritonitis, pericarditis, renal, spinal, disseminated or osteoarticular TB) and those suspected of having MDR/RR-TB (in contact with a person with confirmed or suspected MDR/RR-TB, or children and adolescents diagnosed with TB who are not responding to first-line TB treatment) should be referred to a specialist for further management if management capacity where they present is insufficient.

Hospitalization should be reserved for children and adolescents where this is clinically indicated. Children and adolescents with medicine toxicity resulting in treatment discontinuation should be referred to the appropriate level of care as needed. Children who present with IMCI danger signs should be referred for immediate hospitalization (80).

Box 5.8 Indications for referral or hospitalization during TB treatment or evaluation

- severe malnutrition (for nutritional rehabilitation);
- signs of severe pneumonia (see definitions);
- other comorbidities (e.g. severe anaemia);
- child or adolescent living with HIV (referral as needed for ART and co-trimoxazole preventive therapy (CPT); hospitalization for severe HIV-associated diseases);
- social or logistic reasons that could impact adherence;
- neonate weighing less than 4 kg;
- severe adverse reactions such as hepatotoxicity (see Section 5.2.10.1) (72).

After discharge from hospital, if treatment is continued at a PHC facility it is important that dosages recommended by the referral centre are followed and clear communication established between the hospital and PHC facility. All patients should be registered and notified to the NTP, either at the hospital or at the PHC facility.

5.2.8.2. Indications for adjuvant therapy

Corticosteroids should be used as part of the treatment for TBM and may be used for the treatment of tuberculous pericarditis. Corticosteroids are sometimes used for other complicated forms of TB (e.g. complications of airway obstruction by TB lymph nodes; severely ill children and adolescents

with disseminated TB), but there are no WHO recommendations regarding use of corticosteroids for forms of EPTB disease other than TBM and tuberculous pericarditis (102). Corticosteroids have been shown to improve survival and reduce morbidity in people with advanced TBM and are recommended for all children and adolescents with TBM (103) (Box 5.9).

Prednisone can be used at a dosage of 2 mg/kg/day orally, increased to 4 mg/kg/day in severely ill children and adolescents (e.g. with danger signs), with a maximum dosage of 60 mg/day for 4 weeks (102). The dose should then be reduced gradually over 2–4 weeks before stopping. Alternatively, dexamethasone 0.3–0.6 mg/kg/day can be used with a similar duration and by using the same method of gradual reduction in the dose (103).

Box 5.9 WHO recommendations on adjuvant corticosteroid therapy

In patients with tuberculous meningitis, an initial adjuvant corticosteroid therapy with dexamethasone or prednisolone tapered over 6–8 weeks should be used (*strong recommendation, moderate certainty in the evidence*).

In patients with tuberculous pericarditis, an initial adjuvant corticosteroid therapy may be used (*conditional recommendation, very low certainty in the evidence*).

Source: WHO consolidated guidelines on tuberculosis. Module 5: management of tuberculosis in children and adolescents. Geneva: World Health Organization; 2022 (3).

5.2.9. Nutritional support

Malnutrition results in the reduction of cell-mediated immunity, thereby increasing the risk of diseases such as TB. The catabolic effect of TB disease results in weight loss and wasting, which in turn worsens the malnutrition, creating a vicious cycle (104). Children and adolescents with TB disease frequently present with failure to thrive or weight loss (see Chapter 3 on diagnostic approaches). Severe malnutrition is associated with increased mortality in children, adolescents and adults with TB (105). Management of TB in children with malnutrition, including nutritional support, is covered in Section 7.6.

5.2.10. Management of adverse events from medicines used to treat drug-susceptible TB

5.2.10.1. Hepatotoxicity

Children and adolescents experience adverse events caused by TB medicines much less frequently than adults (6). The most important adverse event is the development of liver toxicity (hepatotoxicity), which can be caused by isoniazid, rifampicin or pyrazinamide. It is not necessary to monitor serum liver enzyme levels routinely, as mild elevation of serum liver enzymes (less than five times the upper normal value) without clinical symptoms is not an indication to stop TB treatment (106).

The following symptoms, however, should lead clinicians to promptly check liver function tests (as a minimum, aspartate aminotransferase (AST), alanine aminotransferase (ALT) and total bilirubin), and all potentially hepatotoxic medicines (e.g. isoniazid, rifampicin, pyrazinamide, co-trimoxazole) should be stopped immediately until results are obtained:

- liver tenderness;
- hepatomegaly;

- persistent nausea, vomiting or loss of appetite;
- jaundice.

If serum liver enzymes (ALT, AST) are more than five times the upper limit of normal, or more than three times the upper limit of normal with symptoms of hepatitis, hepatotoxic medicines should be stopped while liver enzymes are monitored. The child or adolescent should complete screening for other causes of hepatitis and be referred to an expert with experience in managing drug-induced hepatotoxicity for further management. In many cases, hospitalization will be necessary for close monitoring and management, as liver function tests will need to be done regularly after each adjustment to the treatment regimen (106).

In general, after liver function has normalized (ALT and total bilirubin less than two times the upper limit of normal), ethambutol and rifampicin may be reintroduced first, and liver function tests repeated after 3–7 days. If there is no worsening in the liver function tests, isoniazid can be restarted, and liver function tests repeated after another 3–7 days. If the liver function tests are stable, isoniazid, rifampicin and ethambutol can be continued. Pyrazinamide should not be reintroduced. Without pyrazinamide, treatment with isoniazid, rifampicin and ethambutol must be given for 9 months.

If liver function tests worsen with reintroduction of rifampicin, a liver-sparing regimen needs to be considered, in consultation with an expert in child and adolescent TB. If severe hepatotoxicity occurs in the continuation phase, while on isoniazid and rifampicin, consultation with an expert in child and adolescent TB is indicated, unless the patient has completed more than 80% of all doses, at which point discontinuing treatment may be the most appropriate choice (106).

With severe forms of TB necessitating continuation of TB treatment, a liver-friendly regimen with non-hepatotoxic medicines may be introduced (e.g. combination of ethambutol, cycloserine, linezolid and a fluoroquinolone). This should be done only in consultation with an expert in the management of DR-TB in children and adolescents.

5.2.10.2. Peripheral neuropathy

Isoniazid may cause symptomatic pyridoxine (vitamin B6) deficiency, particularly in severely malnourished children and children living with HIV. Peripheral neuropathy is characterized by pain, burning or tingling in the hands or feet, numbness or loss of sensation in the arms and legs, muscle cramps or twitching. In young children, this may result in changes to gait or refusal to walk. Supplemental pyridoxine at a dosage of 0.5–1 mg/kg/day is recommended in severely malnourished children, children living with HIV, and adolescents who are pregnant. The dosage can be increased to 2–5 mg/kg/day in those with persistent signs of peripheral neuropathy due to pyridoxine deficiency.

5.2.10.3. Optic neuritis

Early signs of ethambutol toxicity can be tested in older children using a colour perception test for red–green colour deficiencies (e.g. Ishihara test cards). Monitoring for optic neuritis can be sought early when there is clinical concern. At WHO-recommended daily doses, the risk of ethambutol toxicity is very low for treatment duration of 2 months, and ethambutol should be used in TB treatment regimens in children of all ages as per WHO recommendations (89). If optic neuritis due to ethambutol is diagnosed, ethambutol should be omitted from the regimen.

5.2.10.4. Overview of common adverse events and their management

Table 5.9 gives an overview of common adverse events and their management.

Table 5.9. Significant and common adverse events of TB medicines by system

System	Medicine	Adverse event	Severity	Frequency	Management	Caution
Dermatological	Rifampicin	Maculopapular rash	Mild to severe	Common	Antihistamines	Discontinue medicine for:
	Isoniazid	Pruritis			Hydrocortisone cream	<ul style="list-style-type: none"> systemic symptoms fever urticaria
	Ethambutol				Low-dose prednisone if other measures fail	<ul style="list-style-type: none"> mucous membrane involvement blistering of skin oedema of lips or eyes wheezing or compromise of airway
	Pyrazinamide					
	Rifampicin	Transient flushing reactions	Mild	Rare	Antihistamines	
	Pyrazinamide					
	Pyrazinamide	Photosensitivity	Mild to severe	Common	Sunscreen Coverage of exposed areas	
	Rifampicin	Severe urticaria or anaphylaxis	Severe	Rare	Referral for evaluation of possible re-challenge or desensitization	Management requires controlled environment with capacity for resuscitation
	Isoniazid					
	Pyrazinamide					
	Ethambutol					

System	Medicine	Adverse event	Severity	Frequency	Management	Caution
Systemic	Rifampicin	Hypersensitivity reactions Flu-like syndrome	Moderate to severe	Rare with daily dosing	Convert to daily dosing if delivering medicine intermittently Typically develops after several months of treatment	For other, more severe hypersensitivity (beyond flu-like symptoms) reactions, rifampicin may have to be stopped
Haematological	Isoniazid Rifampicin	Marrow suppression, which may result in decreased haemoglobin, platelets and white blood cells	Mild to severe	Rare	Consider discontinuation for severe anaemia, leukopenia or thrombocytopenia that worsens on treatment	Children with TB may have suppressed cell lines at baseline without drug-related effects
Neurotoxicity	Isoniazid	Peripheral neuropathy	Mild to severe	Common in severely malnourished and children living with HIV Otherwise rare	Check and correct electrolyte abnormalities Evaluate other medicines for contribution Assess pyridoxine dose and increase if needed Trial low-dose nonsteroidal anti-inflammatory or acetaminophen	Isoniazid-related peripheral neuropathy generally improves after discontinuation Monitor extremity reflexes and gait in all infants and children

System	Medicine	Adverse event	Severity	Frequency	Management	Caution
Ophthalmic	Ethambutol Isoniazid	Optic neuropathy Neuritis	Severe	Very rare in children	Refer if there are concerns about decreased acuity or colour discrimination developing on treatment	Conduct baseline visual acuity and colour vision assessment in older children Observe fixation and tracking in infants
Hepatic	Isoniazid Rifampicin Pyrazinamide	Hepatitis Symptoms of unexplained nausea Decreased appetite and vomiting may appear before jaundice	Mild to severe	Rare in most children but more common in children living with HIV	Discontinue if >5 times upper limit of normal, or >3 times upper limit of normal with hepatitis symptoms and refer for staged reintroduction If <5 times upper limit of normal, or <3 times upper limit of normal with symptoms of hepatitis, monitor closely	Rifampicin is more commonly associated with cholestatic pattern Isoniazid and pyrazinamide more commonly result in isolated ALT/AST increases

Adapted from: Drug-Resistant Tuberculosis, A Survival Guide For Clinicians, Third Edition: Curry International Tuberculosis Center and California Department of Public Health; 2016.

5.2.11. Treatment adherence

Children and adolescents with TB, their parents, other family members and other caregivers should receive education about TB and the importance of completing treatment. Especially for younger children, the support of their parents, caregivers and immediate family is important for successful treatment. In many settings, HCWs can observe or administer treatment to children or adolescents. If this arrangement is not convenient for the patient or their family, a trained community member or CHW (preferably a person other than the child's parent or immediate family) can help (107). Adolescents have unique adherence challenges and can benefit from age-specific tailored interventions (see Section 7.4).

The shorter 4-month treatment regimens may improve adherence by decreasing the required number of visits to health care facilities. Children and adolescents should receive TB-related care, free of charge. Child-friendly FDCs should be used to simplify administration and adherence (100).

Adherence to the full course of treatment can be a challenge in children and adolescents, especially as they may rapidly improve on treatment. Most children with TB will start to show signs of improvement after 2–4 weeks of TB treatment. Continuing treatment as prescribed until completion, even if the child or adolescent is feeling better, requires a thorough understanding of the reasons for the length of the treatment course. Using a person- and family-centred approach, and offering ongoing education to the caregiver, family and child or adolescent are important (Box 5.10) (6).

Box 5.10 Important messages for treatment supporters of children and adolescents with TB

- Have an education session with the adult who will support the child or adolescent and ensure treatment adherence. The session should cover TB disease, the medicines, dosages and preparations used, and adverse events.
- Get feedback from the adult to check they have understood everything.
- Give the adult information about side-effects and what to do if they occur.
- Show the adult how to mark the treatment card (if given), check the card at each visit with the adult and child, and discuss adherence and side-effects.
- Review the need for transport or nutritional support to enable successful follow-up, and provide resources if available.
- Engage adolescents in their care (see Section 7.4).

5.2.12. Follow-up and monitoring of children and adolescents on TB treatment

All children and adolescents initiated on TB treatment should undergo a monitoring assessment at the following intervals as a minimum:

- HIV-negative children and adolescents: 2 weeks and 4 weeks after the start of treatment, at the end of the intensive phase (after 2 months), and then every 2 months until completion of treatment at 4 months or 6 months (depending on regimen used).
- Children and adolescents living with HIV: 2 weeks and 4 weeks after the start of treatment, and then every month until completion of treatment at 4 months or 6 months (depending on regimen used).

used). Children with advanced HIV should be monitored more frequently in accordance with existing recommendations for advanced HIV care (78).

- Clinical monitoring requirements for the shorter regimen are the same as for the 6-month regimen. Treatment outcomes are determined at the end of treatment, at 4 months for the short regimen and at 6 months for the standard regimen. The definition of successful treatment completion takes into account that the expected number of doses is reduced in the shorter regimen.

Monitoring should include the following as a minimum:

- Assess for resolution or persistence of TB-related symptoms, symptoms of side-effects of medicines, and other symptoms.
- Measure weight – dosages should be adjusted depending on weight gain.
- Assess adherence – review the treatment card and discuss with the patient, caregivers and other treatment supporters.
- Follow-up sputum samples for smear microscopy 2 months after the start of treatment and at treatment completion may be collected from any child who was Xpert MTB/RIF-positive, Xpert Ultra-positive, smear-positive or culture-positive at diagnosis if the treatment site has capacity to perform the test. Symptomatic improvement and weight gain are, however, more valuable markers of treatment success or failure (72). If a follow-up smear is positive, the patient should complete additional investigations to assess for drug resistance (Xpert MTB/RIF or Ultra, TB culture and DST or molecular tests for drug resistance) and other causes of poor treatment response (see Box 5.12). In children who cannot expectorate, a repeat specimen at the end of treatment is not necessary if the specimen collected at 2 months is negative.
- Repeat sample collection at 2 months in children with unconfirmed TB is not indicated unless there is an inadequate clinical response without symptomatic and nutritional improvement.
- Follow-up CXR is not needed if the child is responding well to TB treatment. Children commonly have a slow radiographic response to treatment and may have persistent radiographic abnormalities at treatment completion (6), but this does not mean they are not responding to treatment.

Box 5.11 School attendance

- ➔ Most young children do not have infectious forms of TB. They can return to (pre)school as soon as they are feeling better and on treatment.
- ➔ Older children and adolescents, and younger children with positive bacteriological tests, should not attend school while they are infectious.
- ➔ After 2 weeks of starting TB treatment, if adherence is assured and there is clinical improvement, most children and adolescents are no longer infectious, can return to school, and do not need to wear masks for the purposes of preventing TB transmission.

5.2.12.1. Follow-up after treatment completion

All patients and caregivers should be counselled to return to the clinic if there is a recurrence of TB symptoms after successful completion of treatment. Children and adolescents may experience a relapse of TB disease or reinfection. Scheduled clinical monitoring is not required for children or adolescents after successful completion of a 6-month course of drug-susceptible TB treatment. If children and adolescents are treated with a 4-month treatment regimen, a follow-up visit or telephone call may be considered at 6 months to assess for recurrence of clinical symptoms (87).

5.2.12.2. Treatment interruption

Interruption in the treatment of drug-susceptible TB should be managed carefully. The duration, time on treatment at which the interruption occurs, and bacteriological status of the child or adolescent before and after the interruption should be considered. Table 5.10 has been modified from existing medical society guidelines to show the management of treatment interruption (109).

Table 5.10. Management of treatment interruption in children and adolescents on drug-susceptible TB treatment

Treatment phase of interruption	Details of interruption	Management
Intensive phase		
Intensive phase: applies to 4- and 6-month regimens	Interruption <14 days	Continue treatment and complete all intensive phase doses
	Interruption ≥ 14 days	Restart intensive phase
Continuation phase (4-month 2HRZ(E)/2HR regimen)		
Continuation phase (4-month regimen)	Completed ≥80% of doses within 8 weeks	Further treatment not necessary
Continuation phase (4-month regimen)	Completed <80% of doses and cumulative interruption <1 month	Complete remaining doses of treatment
Continuation phase (4-month regimen)	Completed <80% of doses and cumulative interruption >1 month	Restart treatment from beginning of intensive phase
Continuation phase (6-month 2HRZE/4HR regimen)		
Continuation phase (6-month regimen) and bacteriologically negative at initiation	Completed ≥80% of doses within 16 weeks	Further treatment not necessary
Continuation phase (6-month regimen) and bacteriologically positive at initiation	Completed ≥80% of doses within 16 weeks	Complete remaining doses of treatment If consecutive lapse is >2 months, use clinical judgement
Continuation phase (6-month regimen)	Completed <80% of doses and cumulative interruption <2 months	Complete remaining doses of treatment
Continuation phase (6-month regimen)	Completed <80% of doses and cumulative interruption ≥2 months	Restart treatment from beginning of intensive phase, particularly if interruption was consecutive

In all circumstances, if TB symptoms recur during the interruption, reassess the child or adolescent with a rapid molecular test and culture/DST to assess for drug resistance.

5.2.12.3. Treatment failure

A person with treatment failure is defined as one whose treatment regimen needed to be terminated or permanently changed to a new regimen or treatment strategy. Reasons for such a change include no clinical or bacteriological response, adverse drug reactions, and evidence of resistance to medicines in the regimen (108).

The possibility of treatment failure should be considered in a child or adolescent who is receiving TB treatment and (72):

- has no symptom resolution or has worsening symptoms;
- shows continued weight loss;
- is smear-positive at 2-months' follow-up (for children and adolescent with bacteriological confirmation at diagnosis).

Box 5.12 summarizes important questions to ask if a child or adolescent is not responding to or is deteriorating on TB treatment.

Box 5.12 Questions to ask in children and adolescents not responding to or deteriorating on TB treatment

- Is the dosage correct?
- Is the child or adolescent taking the medicines as prescribed (good adherence)?
- Is it possible that the child or adolescent has poor gastrointestinal absorption of the medicine?
- Does the child or adolescent have medicine toxicity?
- Is the child or adolescent living with HIV? If so, has the child or adolescent developed IRIS or other opportunistic infections?
- Is the child or adolescent severely malnourished, and is SAM managed appropriately?
- Is there a reason to suspect DR-TB (index patient has DR-TB or is not responding to treatment)?
- Is there a reason for the illness, other than or in addition to TB?

Poor adherence is a common cause of treatment failure. Treatment failure also suggests the possibility of RR/MDR-TB and needs careful assessment with additional diagnostic evaluations. It may also be more common in children and adolescents living with HIV (79).

5.2.12.4. Children and adolescents requiring retreatment for TB

Box 5.13 WHO recommendation on retreatment regimens

In patients who require TB retreatment, the category II regimen^a should no longer be prescribed, and drug susceptibility testing should be conducted to inform the choice of treatment regimen (*good practice statement*).

^a Category II regimen is a regimen previously recommended by WHO for people with TB who require retreatment due to treatment interruption or recurrence of disease (2HRZES/1HRZE/5HRE).

Source: WHO consolidated guidelines on tuberculosis – Module 5: management of tuberculosis in children and adolescents. Geneva: World Health Organization; 2022 (3).

Children and adolescents eligible for retreatment due to recurrence of TB symptoms secondary to relapse or reinfection or treatment interruption resulting in the need to restart treatment should be referred for a rapid molecular test to determine at least rifampicin resistance, and preferably also isoniazid resistance status, especially if this is within 6–12 months of treatment completion.

Based on the drug susceptibility profile, a treatment regimen can be repeated if no resistance is documented. If rifampicin resistance is present, an MDR/RR-TB regimen should be prescribed according to WHO recommendations.

In children and adolescents who have had treatment interruption, the reason for the interruption should be addressed, such as medicine stockouts, adverse effects from medicines, or need for additional patient or provider education.

Children and adolescents with previous treatment for unconfirmed TB should not be retreated for unconfirmed TB without referral to a centre with expertise in child TB management and paediatric care.

5.2.12.5. Registration of TB treatment in children and adolescents

After a clinician has decided to start treatment in a child based on bacteriological testing or as a result of a treatment decision algorithm, the child should be registered with the NTP. This applies to all services and programmes where children and adolescents with TB are diagnosed, including public non-NTP services and private-sector facilities and practitioners. Underreporting of children and adolescents diagnosed with TB in these sectors contributes to the high proportion of missing children and adolescents with TB. Children and adolescents diagnosed with TB in hospitals who die before treatment initiation or discharge should also be registered (5).

Local monitoring of specimen collection by specimen types, diagnostic tests, results and clinical diagnosis in a TB laboratory register (or equivalent) is advised. For countries with case-based electronic recording and reporting systems, all children and adolescents treated for TB should be reported by the NTP in one of four age bands (0–4, 5–9, 10–14 and 15–19 years):

- Record the diagnostic category, treatment regimen and treatment start date on the child's growth monitoring card, TB treatment card and health unit TB register.
- Record the child's weight at each visit on their growth monitoring card and TB treatment card (weight is important for monitoring the treatment response and to adjust dosing.)
- Record treatment outcomes on the TB register and report them to the NTP for all children and adolescents.
- Outcome categories for children and adolescents are the same as for adults (108). Of note, few younger children with TB would meet the criteria for "cured" as they are less likely to have bacteriologically confirmed TB. Further, in most settings, children who cannot expectorate are not

required to be retested for evidence of a bacteriological response at multiple occasions beyond a 2-month assessment, unless there are other indications of a poor treatment response.

Key messages

- The principles of TB treatment in children and adolescents are the same as for adults.
- In children and adolescents aged between 3 months and 16 years with non-severe drug-susceptible TB, a 4-month regimen (2HRZ(E)/2HR) should be used.
- In adolescents aged 12 years and over, a 4-month treatment regimen (2HPMZ/2HMP) may be used, irrespective of PTB disease severity.
- In children with TBM, a 6-month intensive treatment regimen (6HRZEto) may be used as an alternative to the standard 12-month regimen (2HRZE/10HR).
- Child-friendly dispersible FDC tablets should be used for children weighing less than 25 kg.
- Children gain weight while receiving TB treatment, and dosages should be adjusted accordingly.
- Caregiver should be identified as treatment supporters for children of all ages, including older children and adolescents.
- Adherence to the full course of treatment should be emphasized and reinforced.
- TB medicines are generally well tolerated in almost all children and adolescents. Side-effects are uncommon. The most important adverse event to look for is hepatotoxicity.
- Ethambutol can be used safely in children at recommended dosages.
- All children and adolescents diagnosed with TB (irrespective of where the diagnosis is made and treatment provided) should be registered and reported to the NTP.

5.3. Treatment of multidrug-resistant and rifampicin-resistant TB in children and adolescents

This section describes a practical approach to the treatment of children with rifampicin-resistant tuberculosis (RR-TB) and MDR-TB (resistant to both rifampicin and isoniazid). It covers identifying children who should be treated for MDR/RR-TB, deciding on the most appropriate treatment regimen, monitoring, and other implementation issues related to treatment.

5.3.1. Identifying children who should be treated for multidrug-resistant and rifampicin-resistant TB

Based on modelling estimates, between 25 000 and 32 000 children and young adolescents aged under 15 years develop MDR-TB disease annually (170). When treated, outcomes of children with MDR/RR-TB are good, with favourable outcomes in 78% (111) and over 90% in some cohorts (112). Despite these good outcomes, relatively few children are diagnosed and treated for MDR/RR-TB each year, with only 12 220 starting treatment between 2018 and 2020 (11% of the United Nations General Assembly High-level Meeting target of 115 000) (7, 9). Most deaths among children with TB are in those who are not treated (17). It is critical, therefore, to ensure timely and appropriate identification, diagnosis and treatment of MDR/RR-TB in children and adolescents.

Contact investigation and screening of child and adolescent contacts of infectious MDR/RR-TB source cases are essential for the rapid diagnosis of children with MDR/RR-TB disease and for prompt initiation

of treatment (113). Evaluation of children who are contacts of people with MDR/RR-TB and diagnosis of DR-TB in children and adolescents are discussed in [Chapter 4](#).

Children with clinically diagnosed or bacteriologically confirmed MDR/RR-TB should be treated with a WHO-recommended regimen. Bacteriologically confirmed MDR/RR-TB is based on identification of *M. tuberculosis* from a specimen from the child or adolescent by molecular or culture-based methods, along with demonstration of at least rifampicin resistance with a genotypic or phenotypic DST. Treatment of children with confirmed MDR/RR-TB should be based on the demonstrated DST results from their isolate (if available).

A clinical diagnosis of MDR/RR-TB can be made based on a clinical diagnosis of TB (TB disease without bacteriological confirmation) and either exposure to a known case of MDR/RR-TB or presence of other risk factors for MDR/RR-TB (child treated previously for TB or exposed to a source case who died from TB or failed TB treatment). Strain concordance between children and their adult source cases is around 83% for isoniazid and rifampicin susceptibility, meaning children are very likely to have TB with the same resistance pattern as their most likely source case (83). Therefore, children with clinically diagnosed MDR/RR-TB should initiate treatment for MDR/RR-TB without delay, while all efforts to confirm the diagnosis by bacteriological testing should be made. Treatment of children and adolescents with clinically diagnosed MDR/RR-TB should be guided by the DST results and the history of exposure to TB medicines of the most likely MDR/RR-TB source case.

If a culture from the child or adolescent ultimately is positive for *M. tuberculosis* and demonstrates MDR/RR-TB, they should be treated according to the DST of their isolate. If a child or adolescent is started on treatment for clinically diagnosed MDR/RR-TB treatment and subsequently has a culture that shows drug-susceptible TB, their treatment can be switched to that for drug-susceptible TB; this is expected to be an uncommon occurrence. If a child or adolescent with clinically diagnosed MDR/RR-TB has a negative culture, the child should complete the originally prescribed course of second-line treatment; they should not stop treatment or switch to drug-susceptible TB treatment.

Improving case-finding of (especially) young children with MDR/RR-TB is critical to reduce the risk of poor outcomes.

5.3.2. Multidrug-resistant and rifampicin-resistant TB treatment regimens for children and adolescents

5.3.2.1. Overview and approach to selecting a treatment regimen

This section covers the standardized shorter all-oral bedaquiline-containing regimen and individualized regimens for children and adolescents not eligible for the shorter all-oral bedaquiline-containing regimen. It also includes other important considerations, including treatment of EPTB and TB/HIV coinfection, and dosing and formulations.

The risks and benefits of each medicine should be considered carefully while designing a regimen. None of the available TB medicines is contraindicated in children. The medicines are generally well tolerated, with some exceptions: injectable agents (aminoglycosides) are associated with hearing loss, which can be difficult to monitor in young children and can have a devastating effect on cognitive and language development, education and socialization (111, 112, 114, 115).

When a decision has been made to treat a child for MDR/RR-TB, two main regimens are available. Current WHO guidelines recommend prioritizing the standardized shorter all-oral bedaquiline-containing regimen for people with MDR/RR-TB. For people not eligible for this regimen, an individualized longer regimen composed of medicines in priority groupings A, B and C should be constructed. Current WHO drug groupings are shown in [Table 5.11](#).

Table 5.11. WHO drug groupings

Group	Drug	Abbreviation
A	Levofloxacin or moxifloxacin	Lfx or Mfx (or M)
	Bedaquiline	Bdq (or B)
	Linezolid	Lzd (or L)
B	Clofazimine	Cfz
	Cycloserine or terizidone	Cs or Trd
C	Ethambutol	E
	Delamanid	Dlm
	Pyrazinamide	Z
	Imipenem-cilastatin in combination with clavulanic acid (amoxiclav)	Ipm-Cln
	Meropenem in combination with clavulanic acid (amoxiclav)	Mpm
	Amikacin or streptomycin ^a	Am or S
	Ethionamide or prothionamide	Eto or Pto
	P-aminosalicylic acid	PAS

^a Amikacin and streptomycin are to be considered only in adolescents aged over 18 years and only if DST results confirm susceptibility, and if high-quality audiometry monitoring for hearing loss can be ensured. Streptomycin is to be considered only if amikacin cannot be used (i.e. is unavailable or there is documented resistance) and if DST results confirm susceptibility (i.e. resistance to streptomycin is not detectable with second-line molecular LPAs and phenotypic DST is required). Kanamycin and capreomycin are no longer recommended for use in MDR-TB regimens.

The 2021 guideline development group reviewed evidence (mainly pharmacokinetic and safety data) on the use of bedaquiline in children aged under 6 years and delamanid in children aged under 3 years. The new recommendations expand the age indications for both bedaquiline (as part of shorter and longer regimens) and delamanid (as part of longer regimens) to children of all ages. These new recommendations make it possible to build all-oral treatment regimens for all children with MDR/RR-TB.

WHO recommendations on treatment of MDR/RR-TB in children and adolescents are given in [Box 5.14](#).

Box 5.14 WHO recommendations on treatment of children and adolescents with multidrug-resistant and rifampicin-resistant TB

Use of bedaquiline in children

In children with MDR/RR-TB aged below 6 years, an all-oral treatment regimen containing bedaquiline may be used (*new: conditional recommendation, very low certainty of evidence*).

This recommendation applies to and complements current WHO recommendations on shorter and longer regimens that contain bedaquiline:

- A shorter all-oral bedaquiline-containing regimen of 9–12 months duration is recommended in eligible patients with confirmed multidrug- or rifampicin-resistant tuberculosis (MDR/RR-TB) who have not been exposed to treatment with second-line TB medicines used in this regimen for more than 1 month, and in whom resistance to fluoroquinolones has been excluded (*conditional recommendation, very low certainty in the evidence*).
- Bedaquiline should be included in longer multidrug-resistant TB (MDR-TB) regimens for patients aged 18 years or more (*strong recommendation, moderate certainty in the estimates of effect*).
- Bedaquiline may also be included in longer MDR-TB regimens for patients aged 6–17 years (*conditional recommendation, very low certainty in the estimates of effect*).

Bedaquiline can therefore be used in children of all ages to treat MDR/RR-TB. Bedaquiline is currently a component of the standardized all oral shorter regimen and a Group A drug for individualized longer regimens.

Use of delamanid in children

In children with MDR/RR-TB aged below 3 years delamanid may be used as part of longer regimens (*new: conditional recommendation, very low certainty of evidence*).

This recommendation complements the current WHO recommendation on longer regimens that contain delamanid:

- Delamanid may be included in the treatment of MDR/RR-TB patients aged 3 years or more on longer regimens (*conditional recommendation, moderate certainty in the estimates of effect*).

Delamanid can therefore be used in children of all ages to treat MDR/RR-TB. Delamanid is currently a Group C drug for individualized longer regimens.

Longer (individualized) regimens for MDR/RR-TB

In MDR/RR-TB patients on longer regimens, all three Group A agents and at least one Group B agent should be included to ensure treatment starts with at least four TB agents likely to be effective, and that at least three agents are included for the rest of treatment if bedaquiline is stopped. If only one or two Group A agents are used, both Group B agents are to be included. If the regimen cannot be composed with agents from Groups A and B alone, Group C agents are added to complete it (*conditional recommendation, very low certainty in the estimates of effect*).

Kanamycin and capreomycin are not to be included in the treatment of MDR/RR-TB patients on longer regimens (*conditional recommendation, very low certainty in the estimates of effect*).

Levofloxacin or moxifloxacin should be included in the treatment of MDR/RR-TB patients on longer regimens (*strong recommendation, moderate certainty in the estimates of effect*).

Linezolid should be included in the treatment of MDR/RR-TB patients on longer regimens (*strong recommendation, moderate certainty in the estimates of effect*).

Clofazimine and cycloserine or terizidone may be included in the treatment of MDR/RR-TB patients on longer regimens (*conditional recommendation, very low certainty in the estimates of effect*).

Ethambutol may be included in the treatment of MDR/RR-TB patients on longer regimens (*conditional recommendation, very low certainty in the estimates of effect*).

Pyrazinamide may be included in the treatment of MDR/RR-TB patients on longer regimens (*conditional recommendation, very low certainty in the estimates of effect*).

Imipenem–cilastatin or meropenem may be included in the treatment of MDR/RR-TB patients on longer regimens ^a (*conditional recommendation, very low certainty in the estimates of effect*).

Amikacin may be included in the treatment of MDR/RR-TB patients aged **18 years or more** on longer regimens when susceptibility has been demonstrated and adequate measures to monitor for adverse reactions can be ensured. If amikacin is not available, streptomycin may replace amikacin under the same conditions (*conditional recommendation, very low certainty in the estimates of effect*).

Ethionamide or prothionamide may be included in the treatment of MDR/RR-TB patients on longer regimens only if bedaquiline, linezolid, clofazimine or delamanid are not used, or if better options to compose a regimen are not possible (*conditional recommendation against use, very low certainty in the estimates of effect*).

P-aminosalicylic acid may be included in the treatment of MDR/RR-TB patients on longer regimens only if bedaquiline, linezolid, clofazimine or delamanid are not used, or if better options to compose a regimen are not possible (*conditional recommendation against use, very low certainty in the estimates of effect*).

Clavulanic acid should not be included in the treatment of MDR/RR-TB patients on longer regimens ^a (*strong recommendation against use, low certainty in the estimates of effect*).

^a Imipenem–cilastatin and meropenem are administered with clavulanic acid, which is available only in formulations combined with amoxicillin. Amoxicillin–clavulanic acid is not counted as an additional effective TB agent and should not be used without imipenem–cilastatin or meropenem.

Sources: WHO consolidated guidelines on tuberculosis. Module 5: management of tuberculosis in children and adolescents. Geneva: World Health Organization; 2022 (3); WHO consolidated guidelines on tuberculosis. Module 4: treatment – drug-resistant tuberculosis treatment. Geneva: World Health Organization; 2022 (116).

5.3.2.2. Shorter all-oral bedaquiline-containing regimen for multidrug-resistant and rifampicin-resistant TB in children

The standardized shorter all-oral bedaquiline-containing regimen may now be used in children of all ages under programmatic conditions.¹⁷ The eligibility criteria for this regimen for children with confirmed MDR/RR-TB are the same as for adolescents and adults:

- no resistance to fluoroquinolones;

¹⁷ New evidence on shorter all-oral bedaquiline-containing regimens will be reviewed by a WHO-convened guideline development group in 2022; therefore, this recommendation will soon be reviewed.

- no previous exposure for more than 1 month to second-line medicines used in this regimen (unless susceptibility to these second-line medicines has been confirmed);
- no severe forms of EPTB (other than peripheral lymphadenopathy);
- no extensive TB disease (presence of cavities or bilateral disease on CXR);
- presence of mutations in both the *inhA* promoter region and the *katG* gene, as determined by first-line LPA (MTBDRplus) in the child or adolescent or their most likely source case, as this suggests that isoniazid at high dose and thioamides are not effective.

Children with a diagnosis of rifampicin resistance only, without further DST (such as a child diagnosed with Xpert MTB/RIF or Xpert Ultra testing on a stool sample but no further DST on respiratory samples), can be treated with available bedaquiline-containing regimens at the discretion of the treating clinician.

The standardized shorter all-oral bedaquiline-containing regimen¹⁸ is summarized as follows:

4–6 Bdq (6) – Lfx – Cfz – Z – E – H^h – Eto/5 Lfx – Cfz – Z – E

The regimen is shown in detail in [Figure 5.2](#).

Figure 5.2. TB medicines and duration of treatment for the standardized all-oral bedaquiline-containing shorter regimen

Month	1	2	3	4	5	6	7	8	9	10	11
Bedaquiline	Orange	Orange	Orange	Orange	Orange	Orange					
High-dose isoniazid	Orange	Orange	Orange	Orange	Blue	Blue					
Ethionamide/ prothionamide	Orange	Orange	Orange	Orange	Blue	Blue					
Levofloxacin	Orange	Orange	Orange	Orange	Orange	Orange	Orange	Orange	Orange	Blue	Blue
Clofazimine	Orange	Orange	Orange	Orange	Orange	Orange	Orange	Orange	Orange	Blue	Blue
Pyrazinamide	Orange	Orange	Orange	Orange	Orange	Orange	Orange	Orange	Orange	Blue	Blue
Ethambutol	Orange	Orange	Orange	Orange	Orange	Orange	Orange	Orange	Orange	Blue	Blue

Orange = standardized MDR/RR-TB treatment course.

Blue = added months if still smear-/culture-positive after 4 months of treatment.

The medicines used in the standardized all-oral bedaquiline-containing regimen have been part of MDR/RR-TB regimens for many years, in similar combinations, for adults and children, except for bedaquiline, which was first recommended for use in adults in 2016 and in children aged over 6 years in 2019. Associated adverse reactions have been widely described (116), and the dosages established (see [Annex 6](#)). Dosages for bedaquiline in children and adolescents aged 0–17 years have recently been updated. For children aged under 6 years, these dosing recommendations are interim, as they were based on limited data and paediatric trials on bedaquiline are ongoing.

¹⁸ WHO published a rapid communication to announce forthcoming updates to treatment regimens for MDR/RR-TB in May 2022, including an alternative 9-month, all-oral, bedaquiline-containing regimen with linezolid instead of ethionamide. See: <https://apps.who.int/iris/rest/bitstreams/1420701/retrieve>

In children on the standardized all-oral bedaquiline-containing regimen who can produce a specimen, if smear or culture is negative at 4 months the treatment can be changed to the continuation phase. If smear or culture is positive at 4 months, the initial phase should be extended until smear or culture converts (maximum duration 6 months).

For children without bacteriological confirmation and those who cannot produce a specimen and who are clinically well, with improvement of clinical symptoms and weight gain, treatment can be changed to the continuation phase after 4 months (bedaquiline to be continued to 6 months).

Children who need an extension of the initial phase, who remain smear- or culture-positive, or who deteriorate further at 6 months should be switched to an individualized regimen. It is important to obtain follow-up specimens for culture and DST before changing treatment, but without waiting for these results. Results should be reviewed and treatment adjusted further as needed.

The pill burden of this regimen is relatively high, especially in the first 4–6 months, which may be challenging for young children, even if dispersible formulations are used. Treatment support is important to support administration.

5.3.2.3. Longer individualized regimens for children with multidrug-resistant and rifampicin-resistant TB who are not eligible for the standardized all-oral bedaquiline-containing regimen

Children who are not eligible for the standardized all-oral bedaquiline-containing regimen include those without bacteriological confirmation (e.g. with a clinical diagnosis); or without fluoroquinolone resistance ruled out (in their own specimens); or with drug-resistant EPTB other than peripheral lymphadenopathy; or with extensive pulmonary disease; or with prior exposure for more than 1 month to the medicines in the shorter regimen.

These children should be treated with longer, individualized treatment regimens. In general, the treatment principles for MDR/RR-TB in children follow those recommended for adolescents and adults.

The following treatment considerations apply specifically for children with MDR/RR-TB (82, 84):

- Individualized regimens should consist of at least four medicines to which the organism is likely to be susceptible. Most medicines will be used for the duration of treatment, but some may be used for shorter periods, such as bedaquiline (recommended for 6 months) or linezolid (often used for shorter durations because of its potential for severe adverse effects). Children and adolescents with extensive forms of MDR/RR-TB may benefit from an additional fifth medicine at least at the beginning of treatment, with the duration depending on the extent of disease, response to treatment, number and efficacy of companion medicines in the regimen, and potential for adverse effects (see [Box 5.15](#)).
- Group A and Group B medicines should be prioritized in the construction of the treatment regimen, as well as delamanid and other Group C medicines (the medicines in Group C in [Table 5.11](#) are ranked by the relative balance of benefit and harm).
- For children of all ages, bedaquiline is recommended to be included as part of individualized treatment regimens. Pharmacokinetic and safety data, especially in children aged under 5 years, are limited. The recommended standard duration of treatment with bedaquiline is 6 months. Extension of bedaquiline beyond 6 months may be considered in some people without other options (e.g. those with fluoroquinolone resistance or intolerance to linezolid), in consultation with a paediatric DR-TB expert and with strict baseline and follow-up monitoring. **In 2019, a guideline development group assessed evidence to determine whether bedaquiline could be used beyond 6 months. Owing to limited evidence and potential residual confounding in the data, the guideline development group was not able to make a statement about the relative efficacy of using bedaquiline beyond 6 months, but it was able to conclude that it was safe to do so, provided appropriate schedules of monitoring are in place.**

- Linezolid is a Group A medicine that has been associated with frequent haematological toxicity, depending on the dose and duration of use. Its use for the full duration of treatment may improve efficacy, but adverse events may limit the duration of use to the first few months (see [Section 5.3.4](#)). If there are few options available, such as for TBM caused by an MDR/RR-TB strain or for MDR/RR-TB with additional fluoroquinolone resistance but linezolid susceptibility, linezolid can be continued for longer durations, such as 6–9 months or longer as adverse effects allow.
- For children of all ages, delamanid is an option to add to MDR/RR-TB regimens if the child has (suspected) fluoroquinolone resistance or severe disease necessitating a fifth medicine. The recommended standard duration of treatment with delamanid is 6 months. Data on its use beyond 6 months have not been assessed by WHO.
- If the regimen cannot be composed with sufficient effective Group A or Group B medicines, addition of ethambutol and/or pyrazinamide (if DST of the child or source case confirms susceptibility) can be considered. Due to difficulties in interpreting its DST, ethambutol should be considered only when it is likely to be effective. P-aminosalicylic acid is another Group C medicine that can be used in children and adolescents if new medicines are not available or a four- or five-medicine regimen cannot be constructed.
- Ethionamide/prothionamide should be used as an additional medicine only if there is no known or suspected *inhA* mutation. Ethionamide should be reserved for situations where more effective medicines (e.g. bedaquiline, linezolid, clofazimine) cannot be used (116).
- In children with fluoroquinolone resistance or with limited treatment options, extension of bedaquiline beyond 6 months and/or a combination of bedaquiline with delamanid may be considered. Data in adults show the combination of bedaquiline and delamanid does not result in a marked increase in adverse events, including QT prolongation (117). Data on concurrent use of bedaquiline and delamanid in children are limited, but there is no reason to expect this would not be similarly safe in children. Careful monitoring of QT prolongation is strongly recommended when these medicines are used together (84).
- Injectable agents (amikacin, streptomycin) should not be used in children because of their risk of permanent hearing loss and their poor tolerability. Hearing loss is a frequent severe adverse effect of aminoglycosides, with a profound impact on language acquisition, ability to learn at school and further development. Amikacin may be included in the treatment of MDR/RR-TB only in people aged 18 years and over on longer regimens when susceptibility has been demonstrated and adequate measures to monitor for adverse reactions can be ensured. If amikacin is not available, streptomycin may replace amikacin under the same conditions.
- Duration of treatment using individualized regimens in children depends on the site and severity of disease (see [Box 5.15](#)) and the extent of resistance (in addition to isoniazid and rifampicin resistance). Children with non-severe disease can usually be treated for less than 18 months. Children with extensive disease may require longer treatment durations, depending on clinical progress, site of disease (e.g. bone or CNS), resistance pattern and number of types of medicines likely to be effective (82).
- Child-friendly formulations should be used whenever possible.
- Monitoring and management of adverse events are essential.

Box 5.15 Extent of disease

In children and young adolescents aged under 15 years, severe disease is usually defined by the presence of cavities, or bilateral lung parenchymal disease, or bilateral mediastinal nodes with airway compression on CXR, or extrapulmonary forms of disease other than peripheral lymphadenopathy.

The occurrence of SAM, advanced immunosuppression or positive TB bacteriology (Xpert MTB/RIF, Ultra, other mWRD, smear, culture) may also be considered when determining the number of effective medicines needed or the treatment duration.

5.3.2.4. Practical approach to designing individualized multidrug-resistant and rifampicin-resistant TB treatment regimens

Table 5.12 summarizes possible individualized MDR/RR-TB treatment regimens for children of all ages and adolescents based on the above-described principles and taking into consideration fluoroquinolone and other resistance and eligibility for the shorter regimen.

Table 5.12. Possible individualized multidrug-resistant and rifampicin-resistant TB treatment regimens for children of all ages and adolescents, by fluoroquinolone resistance and disease severity

Fluoroquinolone susceptibility	Regimen ^a	Additional medicines
Fluoroquinolone-susceptible	Bdq-Lfx-Lzd-Cfz-(Cs)	Cs, Dlm, PAS, Eto ^{b,c} (E, Z) ^d
Fluoroquinolone-resistant	Bdq-Lzd-Cfz-Cs- (Dlm) ^e	Dlm ^e , PAS, Eto ^{b,c} (E, Z) ^d
Fluoroquinolone-resistant and bedaquiline (±clofazimine)-resistant	Lzd-Cs-Dlm ^e -E-Z ^d	Mpm/Clav, Eto ^{b,c} , PAS ^c

Bdq: bedaquiline; Cfz: clofazimine; Cs: cycloserine; Dlm: delamanid; E:ethambutol; Eto: ethionamide; FQ: fluoroquinolone; Lfx: levofloxacin; Lzd: linezolid; Mpm/Clav: meropenem–clavulanate; PAS: P-aminosalicylic acid; Z: pyrazinamide.

^a Medicines in parentheses in this column are suggestions for a fifth medicine when there is severe disease.

^b Use ethionamide only if the child or source case does not have a known or suspected *inhA* mutation.

^c P-aminosalicylic acid and ethionamide showed effectiveness only in regimens without bedaquiline, linezolid, clofazimine or delamanid, and are proposed only when other options to compose a regimen are not possible.

^d Ethambutol and pyrazinamide should be considered if there is evidence of susceptibility and a regimen with sufficient medicines cannot be composed.

^e When administering delamanid and cycloserine concurrently, monitoring for neuropsychiatric side-effects is important.

The bedaquiline, pretomanid and linezolid regimen for multidrug-resistant TB with additional fluoroquinolone resistance in adolescents aged 14 years and over

The bedaquiline, pretomanid and linezolid (BPAL) regimen is composed of 6–9 months of bedaquiline, pretomanid and linezolid. It may be used in adolescents aged 14 years and over under operational research conditions conforming to WHO standards, which include research subject to ethical approval, patient-centred care and support, predefined eligibility criteria, patient-informed consent, implementation according to the principles of good clinical practice, active drug safety monitoring and management, treatment monitoring, outcome evaluation, and comprehensive standardized data collection.

Box 5.16 WHO recommendation on the BPaL regimen

A treatment regimen lasting 6–9 months composed of bedaquiline, pretomanid and linezolid (BPaL) may be used under operational research conditions in multidrug-resistant tuberculosis (MDR-TB) patients with TB that is resistant to fluoroquinolones, who have either had no previous exposure to bedaquiline and linezolid or have been exposed for no more than 2 weeks (conditional recommendation, very low certainty in the estimates of effect).

Source: WHO consolidated guidelines on tuberculosis. Module 4: treatment – drug-resistant tuberculosis treatment. Geneva: World Health Organization; 2022 (116).

Eligibility criteria for treatment with the BPaL regimen are all of the following:

- bacteriologically confirmed PTB and laboratory-confirmed resistance to rifampicin and fluoroquinolones with or without resistance to injectable agents;
- age at least 14 years at the time of enrolment;
- weight 35 kg or over;
- informed consent to be enrolled in the operational research project and to adhere to the follow-up schedule (signed or witnessed consent if the patient is illiterate, or signed or witnessed consent from a child's parent or legal guardian);
- for adolescent girls, no pregnancy or breastfeeding and willingness to use effective contraception;
- no known allergy to any BPaL component medicines;
- no evidence in DST results of resistance to any of the component medicines, or no previous exposure to any of the component medicines for 2 weeks or more;
- no EPTB, including meningitis, other CNS TB or TB osteomyelitis.

Further details on the BPaL regimen can be found in the *WHO operational handbook on tuberculosis. Module 4: treatment – drug-resistant tuberculosis treatment* (82).

5.3.2.5. Special considerations: TB meningitis

Recommendations on longer MDR/RR-TB treatment regimens for adults also apply to children and adolescents with severe forms of extrapulmonary MDR/RR-TB, as they are not eligible for the short all-oral bedaquiline-containing regimen. In addition to the principles described above, treatment of MDR/RR-TBM should be guided by the ability of the medicines to cross the blood–brain barrier and resulting CSF concentrations, where this is known (Table 5.13).

Table 5.13. Cerebrospinal fluid penetration of TB medicines used for treatment of multidrug-resistant and rifampicin-resistant TB

Medicine	CSF penetration
Levofloxacin, moxifloxacin, linezolid, cycloserine, ethionamide, meropenem, pyrazinamide	Good penetration
Isoniazid in presence of isoniazid resistance, P-aminosalicylic acid, amikacin	Poor penetration, except in presence of meningeal inflammation
Ethambutol	Poor penetration
Bedaquiline, delamanid, clofazimine	Limited data available

Medicines that should generally be prioritized for treatment of MDR/RR-TB TBM because of their good CSF penetration include the fluoroquinolones (levofloxacin, moxifloxacin), linezolid, cycloserine/terizidone and ethionamide (if there is likely to be susceptibility). Regimens for people with MDR/RR-TB TBM ideally should include at least three medicines with good CSF penetration; additional medicines should then be added following the principles described above to construct a regimen that considers the severity of disease. For example, the addition of bedaquiline should be considered if there is pulmonary disease in addition to CNS disease.

Although shorter durations of linezolid may be appropriate in many cases of pulmonary MDR/RR-TB, treating MDR/RR-TB TBM with linezolid for longer durations, including possibly throughout the treatment duration, is advisable if tolerated, given its good CSF penetration and the lack of other good treatment options.

Most other forms of extrapulmonary MDR/RR-TB can be treated similarly to pulmonary MDR/RR-TB using the longer regimen. Osteoarticular (including spinal) MDR/RR-TB is usually treated for at least 18 months because of uncertainty regarding bone penetration of TB medicines and since this type of extrapulmonary disease is considered severe.

5.3.2.6. Special considerations: TB/HIV coinfection

The approach to designing MDR/RR-TB treatment regimens is largely the same for all children and adolescents, regardless of HIV status, although potential drug–drug interactions should be avoided through the careful selection of TB medicines in the regimen.¹⁹

The most important clinically significant drug–drug interaction with ART that must be considered is for bedaquiline. ART regimens including integrase inhibitors such as DTG are the best option for children living with HIV receiving bedaquiline, as clinically significant drug–drug interactions are not expected. ART regimens that contain EFV should be avoided in children and adolescents while they are on bedaquiline, as EFV substantially lowers the concentrations of bedaquiline (118). Other options for children living with HIV on ART receiving bedaquiline are:

- LPV/r – co-treatment with LPV/r may result in elevated bedaquiline exposures, but experience has not shown this to result in an increase in adverse effects, so this may be considered with careful monitoring (119, 120).
- NVP – the reduced efficacy of NVP-containing regimens means this is not an ideal choice when other options are available and as, indicated above, substitution with EFV is not an option.
- Triple nucleoside reverse-transcriptase inhibitor (NRTI) regimen – this is not recommended routinely if there are other options, especially if the viral load is high, as this regimen has reduced potency.

5.3.3. Dosing and formulations of second-line TB medicines in children and young adolescents

5.3.3.1. Dosing

In general, TB medicines should be dosed according to body weight. Dosing of bedaquiline and delamanid for children and young adolescents aged under 15 years was updated in 2021 following an expert consultation meeting convened by WHO. These dosing recommendations are included in Annex 6 and may be updated as evidence emerges, especially for the youngest age groups, for which there is very limited evidence. Monthly monitoring of body weight is especially important in children and adolescents, with adjustment of doses as children gain weight. For dosing recommendations for adolescents aged 15 years and over, see Annex 1 of the *WHO operational handbook on tuberculosis. Module 4: treatment – drug-resistant tuberculosis treatment* (82).

¹⁹ A useful tool to check drug–drug interactions can be found at <https://www.hiv-druginteractions.org/>

The bioavailability (absorption) of bedaquiline, delamanid and clofazimine are significantly improved when given with food, especially high-fat meals, and so they should be given with food whenever possible. Delamanid is recommended to be administered separately in time (ideally 1 hour) from other medicines, including TB and ART medicines, to avoid potential negative effects on delamanid absorption (121).

5.3.3.2. Formulations

Child-friendly dispersible formulations of many second-line TB medicines have been developed. These should be procured by NTPs and are strongly preferred for the treatment of young children with MDR/RR-TB over adult formulations, which must be manipulated (split, crushed, dissolved). Many of these are available through GDF, including bedaquiline 20 mg, delamanid 25 mg,²⁰ levofloxacin 100 mg, moxifloxacin 100 mg, pyrazinamide 150 mg, ethambutol 100 mg, isoniazid 100 mg, ethionamide 125 mg and cycloserine 125 mg minicapsules. Practical instructions for their use have been developed by the Sentinel Project on Pediatric Drug-Resistant (122). A linezolid 150 mg dispersible tablet is being developed. For clofazimine, a 50 mg tablet formulation that can be dissolved in water in 2–5 minutes may be easier to administer to young children than the soft-gel capsule formulation.

The non-availability of child-friendly formulations should not be a barrier to treating children for MDR/RR-TB. Although not ideal, manipulated (split, crushed or dissolved) adult formulations can be used if other options are not available, especially when data exist about their bioequivalence. Bedaquiline adult tablets (100 mg) crushed and suspended in water have been shown to be bioequivalent to tablets swallowed whole and can be used to treat MDR/RR-TB in children if the dispersible tablet formulation of bedaquiline is unavailable or to facilitate administration in children who cannot swallow whole tablets (123). It is also possible to prepare sugar-containing and sugar-free extemporaneous liquid formulations of bedaquiline using the adult 100 mg formulation (Benefit Kids project, unpublished data)²¹.

For children and other people who cannot swallow whole tablets, a pharmacokinetic and bioavailability study has shown that the adult 50 mg tablet of delamanid can be dispersed in water with similar bioavailability as whole tablets (Benefit Kids project, unpublished data)²². It is possible to prepare sugar-containing and sugar-free extemporaneous liquid formulations of delamanid using the adult 50 mg tablet (Benefit Kids project, unpublished data)²³. Data on palatability are not available.

These bedaquiline and delamanid formulations use easily accessible ingredients and equipment and can be prepared in any pharmacy or dispensary. Detailed instructions for the preparation of these extemporaneous formulations are forthcoming.

5.3.4. Monitoring of children and adolescents on multidrug-resistant and rifampicin-resistant TB treatment

Once on MDR/RR-TB treatment, children and adolescents must be monitored regularly to evaluate their response to treatment; identify treatment failure early; monitor for adverse events; and provide adherence, psychosocial and financial support to children and their caregivers.

²⁰ A delamanid 25 mg dispersible tablet was not available at the time of the guideline development group meeting in May–June 2021, but it has since become available and is now listed in the GDF medicines catalogue (<http://stoptb.org/assets/documents/gdf/drugsupply/GDFMedicinesCatalog.pdf>).

²¹ Taneja R, Nahata MC, Scarim J, et al. Stable sugar and sugar-free bedaquiline suspensions: practical implementation of pediatric dosing in the field. BENEFIT Kids Project, unpublished data.

²² Zou Y, Svensson E, Hesselting AC, et al. Relative Bioavailability of Delamanid 25mg, 50mg and 100mg, Administered to Healthy Adults under Fed Conditions Dispersed in Water Compared to Tablet Form: a Randomized Crossover Study. BENEFIT Kids Project, unpublished data.

²³ Nahata MC, Scarim J, Scarim A, et al. Stable sugar and sugar-free liquid formulations of delamanid for use in patients with rifampicin-resistant tuberculosis. BENEFIT Kids Project, unpublished data.

5.3.4.1. Monitoring response to treatment

Monitoring the response to treatment in children and adolescents includes clinical, radiological and microbiological parameters. In children, microbiological monitoring of the response to treatment may be challenging for the same reasons as it being difficult to obtain a microbiological diagnosis. In children and adolescents with a bacteriologically confirmed diagnosis, however, it is important to monitor smear and culture conversion and confirm cure, as recommended by WHO. Once cultures have become negative or in children who have never had a bacteriologically confirmed diagnosis (i.e. clinically diagnosed cases), repeated respiratory sampling may not be useful if the child is showing a good clinical response.

Due to challenges with microbiological monitoring, careful monitoring of the clinical and microbiological response to treatment is important. The best indicators of a positive clinical response to treatment are improvement of clinical symptoms and weight gain. All children on treatment for MDR/RR-TB should have regular clinical follow-up with weight monitoring and assessment of growth and improvement in nutritional measures (WFA and other indicators). Radiographic abnormalities from TB may resolve slowly. Although steady improvement in radiographic findings is expected, some abnormalities may persist to the end of treatment.

Recurrence or worsening of symptoms, failure to gain weight or loss of weight are often the first signs that treatment is failing. The presence of these or worsening of radiographic abnormalities should prompt a careful assessment of adherence and the effectiveness of the treatment regimen. In such cases, follow-up specimens for mycobacterial culture and DST are required.

5.3.4.2. Monitoring for adverse effects

Routine safety monitoring of treatment should generally follow the recommended approach in adults and should be guided by the known adverse effect profile of the medicines included in the regimen. Table 5.14 summarizes the most common adverse effects of the medicines used for MDR/RR-TB.

Table 5.14. Adverse effects of medicines used for multidrug-resistant and rifampicin-resistant TB by group

Group and name	Main adverse effects
WHO Group A	
Levofloxacin (Lfx)	Sleep disturbance Gastrointestinal disturbance Arthralgia/arthritis Headache Idiopathic raised intracranial pressure
Moxifloxacin (Mfx)	As for levofloxacin QT interval prolongation
Bedaquiline (Bdq)	Headache Nausea Liver dysfunction QT interval prolongation Arthralgia

Group and name	Main adverse effects
Linezolid (Lzd)	Diarrhoea Headache Nausea Myelosuppression Peripheral neuritis Optic neuritis Lactic acidosis Pancreatitis
WHO Group B	
Clofazimine (Cfz)	Skin discolouration Ichthyosis QT interval prolongation Abdominal pain
Cycloserine (Cs)/terizidone (Trd)	Neurological and psychological adverse effects Severe depression and suicidal ideation in adolescents
WHO Group C	
Ethambutol (E)	Optic neuritis
Delamanid (Dlm)	Nausea and vomiting Dizziness Paraesthesia Anxiety QTc prolongation Hallucinations and night terrors
Pyrazinamide (Z)	Arthralgia/arthritis (especially together with fluoroquinolone use) Hepatitis Skin rashes
Meropenem (Mpm)	Hypersensitivity reactions Seizures Nausea and vomiting Diarrhoea Hepatic and renal dysfunction
Amikacin^a (Am) or streptomycin (S)	Ototoxicity (irreversible) Nephrotoxicity
Ethionamide (Eto)/ prothionamide (Pto)	Gastrointestinal intolerance Metallic taste Hypothyroidism

Group and name	Main adverse effects
P-aminosalicylic acid (PAS)	Gastrointestinal intolerance Hypothyroidism Hepatitis
Other medicines	
Isoniazid (H) high-dose^b	Hepatitis Peripheral neuropathy
Amoxicillin-clavulanate (amoxiclav)	Gastrointestinal intolerance Hypersensitivity reactions Seizures Hepatic and renal dysfunction
Pretomanid	Peripheral neuropathy Acne Anaemia Nausea and vomiting Headache Liver dysfunction Rash Pruritus Gastrointestinal intolerance

^a Not recommended for use in children and adolescents aged under 18 years.

^b If isoniazid is used, supplement with pyridoxine (vitamin B6) in infants and adolescents, in malnourished children, in children living with HIV, and when high-dose isoniazid is used to prevent peripheral neuropathy.

Source: adapted from Schaaf HS, Thee S, van der Laan L, et al. Adverse effects of oral second-line antituberculosis drugs in children. *Expert Opin Drug Saf.* 2016;15(10):1369–1381 (124); and https://www.tballiance.org/sites/default/files/assets/Pretomanid_Full-Prescribing-Information.pdf.

Key monitoring considerations for common or important adverse effects of MDR/RR-TB in children are described below (125, 126). The principles of monitoring in adolescents are similar to adults.

Electrocardiogram monitoring

Patients receiving any combination of the potentially QT-prolonging medicines (clofazimine, bedaquiline, delamanid or fluoroquinolones) should have regular electrocardiogram (ECG) monitoring. Given the composition of currently recommended regimens, most people being treated for MDR/RR-TB will be receiving one or more of these medicines and will need ECG monitoring. The fluoroquinolones are also known to prolong the QT interval. The effect of levofloxacin is relatively minimal, and ECG monitoring is therefore not critical for levofloxacin. Moxifloxacin, however, has a greater QT-prolonging effect and ECG monitoring should be considered when administered with other QT-prolonging medicines.

Ideally, an ECG should be done at baseline, 2 weeks and 4 weeks, and then every 4 weeks while on treatment and additionally as clinically indicated. The risk of a severely elevated QT interval (QTcF \geq 500 ms) does not appear to be high in children or adolescents (82). If frequent monitoring is not feasible, then measurement at baseline, 4 weeks, 8 weeks and 24 weeks and additionally as clinically indicated may be a reasonable approach. As some of these medicines have long half-lives, it may take weeks before the maximum effect on the QT interval is observed.

Calculation of the corrected QT interval in children should generally follow the same procedures as for adults. Bazett's formula may overcorrect at high heart rates that are normal in young children (resulting in a spuriously high QTc interval), so Fridericia's formula (QTcF)²⁴ is preferred in children. The use of paediatric-sized chest leads in young children with very small chests may improve accuracy.

Management of QTcF prolongation in children should follow the same steps as in adults, with symptom assessment, repeat of the ECG, electrolyte assessment and replacement if relevant, nutritional assessment, checking thyroid functions (ethionamide and P-aminosalicylic acid), and review of other medicines and possible clinical conditions. QTcF over 450 ms is considered prolonged. QTcF of 500 ms or over raises the risk of a potentially life-threatening arrhythmia, and strong consideration should be given to withholding potentially QT-prolonging medicines until the QT interval has improved or withdrawing the culprit medicine as needed (82).

Full blood count and differential white cell count

Bone marrow toxicity (anaemia, thrombocytopenia or neutropenia) is frequently observed in people treated with linezolid. It is dose- and duration-dependent, meaning the risk increases with higher exposures and longer treatment durations. The effect can be severe and progress rapidly. In a small prospective study of children with MDR/RR-TB, 10 of 17 treated with linezolid developed anaemia (59%), including 3 with grade 3 events and 2 with grade 4 events (127).

Ideally, a full blood count with a differential should be done before starting treatment, then every 2 weeks for the first 2 months, and then every 4 weeks while on linezolid. This approach helps identify adverse events early. As cytopenias can progress rapidly, a full blood count should be repeated weekly if there is a meaningful decrease (e.g. by one or more grades) in haemoglobin, platelet or neutrophil counts. Temporary interruption of linezolid may be needed for worsening cytopenias, including to allow time for other causes to be assessed. Anaemia, thrombocytopenia and neutropenia are usually reversible after stopping linezolid. Linezolid may need to be discontinued permanently, especially if the child had severe cytopenias, but it can be restarted at a lower dose if it is a key medicine in the regimen.

Monitoring for other toxicities related to linezolid is also important, including for peripheral neuropathy and optic neuritis. Testing reflexes at baseline or undertaking regular pinprick testing can be done to monitor for toxicities. Testing visual acuity in children at baseline and throughout treatment using symbol charts or "tumbling Es" can be done. For infants and toddlers, visual tracking of objects such as a finger or small toy can be used.

Neuropsychiatric side-effects

Monitoring for neuropsychiatric adverse events, including hallucinations, is important in children treated with medicines that have known neuropsychiatric side-effects, such as delamanid and cycloserine. These events should be reported through the national pharmacovigilance system.

Thyroid function testing

Hypothyroidism is a frequent adverse effect of ethionamide, prothionamide and P-aminosalicylic acid. The risk is higher when P-aminosalicylic acid is combined with ethionamide or prothionamide (124). Signs and symptoms of hypothyroidism are nonspecific and may be difficult to assess in young children. Hypothyroidism may have a negative impact on neurodevelopment in young children. It is important to perform regular (every 2 months) laboratory monitoring of thyroid function in all children taking any of these medicines until they have been stopped, and to supplement with levothyroxine if there is clinical or laboratory evidence of hypothyroidism.

²⁴ Fridericia's formula: $QTcF = QT/RR(0.33)$.

Assessments for hepatotoxicity

Ideally, children should have ALT with or without AST and bilirubin levels measured at baseline. One possible approach to monitoring for hepatotoxicity is to repeat at least ALT every 4 weeks (monthly) for the first 6 months, every 8 weeks thereafter, and additionally as clinically indicated. Clinical indications for liver function testing (at least ALT) are new-onset vomiting (starting after the patient is stabilized on treatment, even if only a few episodes), abdominal pain or tenderness (especially over the right upper quadrant) and jaundice.

If the patient is jaundiced or has raised bilirubin levels and raised ALT, or there are clinical symptoms with ALT more than three times normal levels, or the patient is asymptomatic with ALT more than five times normal levels, all hepatotoxic medicines should be discontinued immediately. Other possible reasons for hepatitis (e.g. hepatitis A, B or C) should be excluded. Normalization of liver enzymes should be awaited. If clinically indicated, hepatotoxic TB medicines can then be reintroduced carefully one by one. If the regimen is not failing, alternative TB medicines may be considered to replace the hepatotoxic medicines.

Social support and adherence measures

WHO recommends providing health education and counselling on the disease and treatment adherence to all people on TB treatment. Adherence counselling and support for the child or adolescent and their family are a crucial part of effective care for MDR/RR-TB care. Strong social support, parental or family counselling, and close relationships with health care providers help to improve care and treatment outcomes in children and adolescents. Children and adolescents should be encouraged to return to normal activities such as school and sports once they are clinically able to handle these important daily activities and are no longer infectious (if bacteriologically confirmed at diagnosis). Recommended treatment adherence interventions include tracers or digital modification monitoring, material and psychological support to the patient or their family, and staff education.

Adolescents with TB may need additional counselling and support, especially if they have other comorbidities such as HIV. In addition to being at increased risk of developing MDR/RR-TB compared with adults, they may also be at risk for less favourable treatment outcomes than adults and younger children (128, 129). Medicines with adverse effects that affect appearance (e.g. clofazimine causing skin discolouration) may affect adherence in adolescents.

Counselling tools and a family-centred approach to the treatment and prevention of DR-TB in children and adolescents have been developed by Médecins Sans Frontières in South Africa (130).

Key messages

- Actively screen all children and adolescents exposed to MDR/RR-TB for TB symptoms (including siblings of children diagnosed with MDR/RR-TB).
- Obtain specimens for molecular testing, mycobacterial culture and first- and second-line DST for all children and adolescents with presumed MDR/RR-TB whenever feasible.
- Offer (empirical) second-line treatment to all children with clinically diagnosed MDR/RR-TB while awaiting bacteriological confirmation, with the regimen based on DST and risk factors of the most likely source case. If cultures are eventually negative, continue on the MDR/RR-TB regimen based on the DST results of the source case.
- Offer the standardized shorter all-oral bedaquiline-containing regimen or an individualized longer regimen following the principles described in this section.
- Use child-friendly formulations of second-line medicines whenever possible.
- Do not use injectable agents in children and adolescents unless an effective regimen cannot be constructed with sufficient oral medicines as a last resort.
- Obtain baseline weight and height in all children with MDR/RR-TB and measure weight regularly throughout treatment. This will form the basis for dose adjustments of the TB medicines for weight, and allow following of weight gain, an important indicator of clinical response.
- Regularly assess the clinical, radiological and microbiological (if relevant) response to treatment.
- Avoid unnecessary hospitalization of children and adolescents with MDR/RR-TB and implement evidence-based infection prevention and control measures when needed.
- Minimize disruption of education by allowing children and adolescents with MDR/RR-TB to go back to school as soon as possible if clinically feasible and no longer infectious.
- Carefully monitor for adverse events and adherence at every visit.
- Offer additional age-appropriate social support for children and adolescents and their families throughout screening, diagnosis, treatment initiation and follow-up.

5.4. Practical guidance for assessment and management of post-TB health in children and adolescents

5.4.1. Post-TB health

Awareness of the consequences of TB disease in children and adolescents that go beyond survival and completion of treatment has increased (131, 132). Each child or adolescent on TB treatment should be assigned a mutually exclusive treatment outcome at the end of treatment, but follow-up and care may need to go beyond the conclusion of TB treatment (71). There is also a need to quantify and monitor the burden of morbidity that occurs after TB treatment has been completed (post-TB health). Improved data on post-TB health will increase awareness of the long-term consequences of TB and provide evidence-based interventions to improve post-TB health and to better plan for the care and support of affected children, adolescents and their families (133).

This section provides a summary of the current evidence base and some practical guidance in three key areas of post-TB health for children and adolescents: TBM, post-TB lung disease and osteoarticular TB. These key areas are based on the debilitating aspects of the disease (TBM and osteoarticular TB) or the high incidence of disease in the affected organ in conjunction with the potential long-term impact (PTB).

The overarching approach for the management of post-TB health includes family-centred care with the goal of promoting the health and well-being of children, adolescents and their families. The aim should be to provide home-based care and involve caregivers in rehabilitation processes as much as possible. Nutritional assessment and health-related quality of life should also be part of the assessment of post-TB health.

5.4.2. Post-TB meningitis in children and adolescents

TBM is the most debilitating form of TB in children. It has high rates of neurological sequelae despite cure and disproportionately affects children aged under 5 years (4, 134). The pooled risk for neurological sequelae in children with TBM was approximately 50% in a systematic review of treatment outcomes, with more advanced clinical stage of disease at diagnosis (stages 2a/b and 3) associated with worse outcomes at the end of treatment (94). Severe functional and neurocognitive disability is seen in 12–26% of children with TBM and requires long-term care and support (95, 96, 135, 136). The outcomes of children who survive TBM into adulthood are not well documented. Information on long-term neurocognitive, functional and behavioural impairment is lacking. Various instruments have been developed for the standardized assessment of neurodevelopmental, neurocognitive, functional and neurobehavioural outcomes or impairments related to TBM based on age, domains tested and type of test (performance-based, self or caregiver rating).

Annex 7 provides an overview of options for neurocognitive and functional testing at the end of treatment and beyond, including throughout schooling, where resources permit (137). Neuroimaging is usually not indicated as there is a poor correlation between imaging findings at the end of treatment and developmental outcomes (138).

Approximately 80% of children with TBM stage 2 or 3 have hydrocephalus, and 20% of these have a non-communicating type that requires ventriculoperitoneal shunting, for which review every 6 months for possible shunt dysfunction is required. Physiotherapists or occupational therapists should be involved to assess and manage muscle tone and the need for transport (e.g. use of a wheelchair).

Children with severe disabling sequelae should be assessed by a multidisciplinary team for general clinical care requirements post-TBM, including pain management. There should also be end-of-treatment assessment for feeding options such as percutaneous gastrostomy with or without gastric fundoplication to relieve gastro-oesophageal reflux.

Approximately 15% of people who survive TBM are completely or partially blind (139). The main causes are chronically raised intracranial pressure (hydrocephalus or tuberculomas), direct involvement of the optic chiasm or optic nerves, and vasculitis related to occipital infarction. Regular evaluation of vision (visual acuity and fields) and promotion of eye health is recommended.

Hypopituitarism due to lesions affecting the hypothalamus, pituitary stalk or the pituitary have been described in 20% of children, often years after recovery from TBM (140). Early recognition of growth restriction, precocious puberty and obesity is beneficial.

Table 5.15 summarizes end-of-treatment clinical assessment in children with TBM.

Table 5.15. End-of-treatment clinical assessment in children with TB meningitis

Specialist	Post-treatment assessment
Neurologist	Clinical assessment and screen for signs and symptoms, with additional referral as needed
	Pain relief
	Shunt assessment for ventriculoperitoneal shunts every 6 months
	Neurological cognitive and functional impairment assessment
	Neuroimaging only if clinically indicated (magnetic resonance imaging if available)
Physiotherapist Occupational therapist	Muscle tone management and transport needs (e.g. wheelchair)
Speech therapist Surgeon Gastrointestinal specialist	Feeding options, including percutaneous endoscopic gastrostomy with or without fundoplication
Endocrinologist	Endocrine assessment in case of thalamic injury

5.4.3. Post-TB lung disease in children and adolescents

Data from adults with TB show that a substantial proportion of people report residual symptoms, including cough and dyspnoea, despite microbiological cure at the end of TB treatment. This impacts on their quality of life and increases the risk of premature death (141–143). Previous PTB substantially increases the risk of recurrent TB, which may, at least in part, be due to residual lung damage (144, 145).

Assessment at the end of TB treatment aims to identify children with post-TB lung disease and should be considered in children with more severe forms of PTB and in children who remain symptomatic at the end of TB treatment. The long-term effects of PTB depend on the type (parenchymal, nodal, other), severity and age. Children with destructive parenchymal disease and those with untreated airway complications and who develop bronchial stenosis may be at particularly high risk of long-term respiratory morbidity. Other children at high risk are those who develop broncho-oesophageal fistula.

If resources permit, long-term follow-up care should be established to manage these children (see Table 5.16). Assessment should include a symptom screen, basic clinical examination and nutritional assessment. Radiological imaging should be considered at the end of treatment to assess residual abnormalities, especially in children with more extensive disease and to allow for comparison if TB recurs, if symptoms are ongoing, or if new respiratory symptoms occur. Chest computed tomography (CT) scans are not widely available in low-resource settings, or indicated, but they should be considered if there are substantial chronic or recurrent respiratory symptoms or signs and radiological abnormalities to evaluate the extent of post-TB lung disease, or to exclude another underlying diagnosis, including potential DR-TB. In such cases, if CT was not done at diagnosis, it should be considered during or at the end of treatment.

Lung function testing should be considered in all children old enough to complete testing (typically aged 4 years and over) who had severe PTB and should include pre- and post-bronchodilation spirometry according to European Respiratory Society and American Thoracic Society guidelines (146) using Global Lung Function Initiative reference ranges (147).

Table 5.16. End-of-treatment assessment of post-TB lung disease in children

	Non-severe PTB	Severe PTB
Clinical assessment and symptom/sign screen	Yes ^a	Yes
Imaging (CXR)		Yes
Lung function (spirometry)		Yes
Health-related quality of life		Yes

^a If there are any residual symptoms, further investigations should be performed.

Adult post-TB lung disease is heterogeneous and includes pathology affecting the airways, parenchyma, and pleural and pulmonary vascular compartments with mixed patterns (131). Medical treatment and long-term follow-up of children and adolescents with post-TB lung disease should be guided by symptoms, type of respiratory disease and additional investigations. Bronchodilation may be effective in children with responsive obstructive airway disease, but evidence is limited. Referral should be made to a respiratory or pulmonology clinic if available for the management of bronchiectasis (148). The roles of pulmonary rehabilitation and airway clearance techniques require further investigation, and their use should be guided by symptoms and recurrent infections.

5.4.4. Post-TB osteoarticular disease in children and adolescents

Although osteoarticular TB is uncommon (approximately 1–2% of all children with TB and 8% of children with EPTB), the potential long-term consequences of the disease, particularly in children, can be major (149).

Spinal TB accounts for approximately half of osteoarticular TB cases and can result in bone loss, increasing deformity (e.g. kyphosis, kyphoscoliosis), late risk of neurological sequelae (e.g. paralysis) and disturbed growth potential (150, 151). Spinal deformity and neurological sequelae can progress even after successful completion of treatment because of the growing skeletal system. Children should be followed annually at least until they reach skeletal maturity to check for potential progressive deformity, which could lead to late neurological, cardiopulmonary or psychological complications. The mainstay for other forms of osteoarticular TB is to maintain the range of motion, prevent contractures and assess for joint destruction (152). Table 5.17 summarizes the multidisciplinary approach required in the management of children with osteoarticular TB.

Table 5.17. Practical guidance to mitigate and assess post-TB morbidity in children with osteoarticular TB

Specialist	Role during and after treatment to prevent morbidity
Clinician	Look for contractures, joint destructions and recurrent TB
	Repeat X-ray every 3 months (as clinically indicated) and at end of treatment to assess joint integrity
	Long-term follow-up for spinal TB for further collapse until age 18 years

Specialist	Role during and after treatment to prevent morbidity
Physiotherapist	From diagnosis to maintain range of motion and prevent contractures
Occupational therapist	Provide night splints to immobilize joints in functional positions
Dietician	Improve nutrition Give vitamin D and multivitamins

5.4.5. Post-TB health-related quality of life

Health-related quality of life is the perceived quality of a person's daily life. It is an holistic way to quantify and measure illness-associated morbidity and the impact of health interventions. Examples of generic, non-disease-specific tools that can be used in young children, including those with TB, are EQ-5D-Y and TANDI (153, 154). EQ-5D-Y is a widely used self-report measure for children aged 8 years and over (155). TANDI was developed as a parent proxy experimental version from EQ-5D-Y and can be used in children aged up to 3 years (154, 156).

6. Models of TB care for children and adolescents

6.1. Introduction

In high TB burden countries, the capacity to manage TB in children and adolescents is often centralized at the tertiary or secondary level of health care rather than being decentralized at the PHC level where children and adolescents with TB or TB exposure commonly seek care (5, 157). Care at higher levels in the health system is often managed in a vertical, non-integrated way. Children and adolescents with TB may go undetected because of missed opportunities for contact investigation, TB prevention, detection and care, and as a result of weak integration of child and adolescent TB services with other programmes and services, especially IMCI, malnutrition and HIV services.

If not addressed, such access challenges contribute to preventable delays in diagnosis and treatment, which may lead to increased disease severity, suffering and mortality. An important step towards improving access to TB prevention and management of TB in children and adolescents is the provision of decentralized, family-centred integrated care (5).

Integrated, patient-centred care and prevention is a key pillar of the WHO End TB Strategy and aims to ensure all people with TB have access to affordable high-quality services according to their needs and preferences (7). This is further underpinned in the 2018 *WHO roadmap towards ending TB in children and adolescents* (5), which calls for the implementation of integrated family- and community centred strategies (Box 6.1).

Box 6.1 Key action number 8 from the 2018 Roadmap towards Ending TB in Children and Adolescents (5)

TB is a disease that directly and indirectly impacts the survival and healthy development of entire households. Appropriate strategies need to be in place to prevent, identify and manage TB in families. The following actions provide an approach to integrate child and adolescent TB into family- and community-centred care:

- Acknowledge the contribution of TB to child morbidity and mortality, and the linkages between TB and common childhood conditions.
- Strengthen global and country-level collaboration and coordination across all health-related programmes engaged in women's, adolescents' and children's health.
- Decentralize and integrate successful models of care for TB screening, prevention and diagnosis with other existing service delivery platforms for maternal and child health and other related services.
- Ensure children and adolescents with common comorbidities (e.g. meningitis, malnutrition, pneumonia, chronic lung disease, HIV) are routinely evaluated for TB.
- Ensure community health strategies integrate children's and adolescents' TB education, screening, prevention and case-finding into training and service delivery activities.
- Increase awareness of and demand for children's and adolescents' TB services in communities and among frontline health workers.
- Empower communities to engage actively in the TB response and strengthen social accountability mechanisms.
- Encourage the use of contextualized local solutions for concerns regarding TB and integration approaches, with a focus on prevention and sharing of models of best practice.
- Ensure focused actions at the community level for prevention of discrimination and stigma with relevant communication strategies, and address legal and human rights barriers for TB care in children.

This chapter focuses on models of care to increase access to children's and adolescents' TB services. WHO recommendations related to models of care for TB services for children and adolescents are presented in [Box 6.2](#). These approaches aim to bring TB services closer to where children, adolescents and families live. As the recommendations are new, evidence on the best ways to implement these recommendations is emerging, and national programmes are encouraged to document examples of best practice in this area.

This chapter also discusses engagement of the private sector, DSD models, and mitigation measures in the context of health emergencies such as the COVID-19 pandemic. Decentralization and family-centred integrated care are included in the list of definitions.

Box 6.2 WHO recommendations on models of TB care for children and adolescents

In TB high burden settings, decentralized TB services may be used in children and adolescents with signs and symptoms of TB and/or those exposed to TB (*conditional recommendation, very low certainty evidence*).

Family-centred, integrated services in addition to standard TB services may be used in children and adolescents with signs and symptoms of TB and/or those exposed to TB (*conditional recommendation; very low certainty evidence*).

Remarks:

- These recommendations are applicable to children and adolescents with signs and symptoms of TB in terms of the impact on case detection. They also apply to children and adolescents who are exposed to TB (TB contacts) who are eligible for TB preventive treatment (TPT), in terms of the impact on provision of TPT. Children and adolescents with signs and symptoms who need evaluation for TB disease may also have a history of exposure to TB (TB contact). Children and adolescents who are TB contacts who do not have signs and symptoms need to be evaluated for TPT eligibility.
- The recommendation on decentralized services refers to enhancing child and adolescent TB services at peripheral levels of the health system and closer to the community, not to replacing specialized paediatric TB services at higher levels of the health system.
- Decentralization should be prioritized for settings and populations with poor access to existing services and/or in high TB prevalence areas.
- Family-centred, integrated approaches are recommended as an additional option to standard TB services, for example alongside specialized services that may have a limited level of integration with other programmes or linkages to general health services.
- Family-centred care is a cross-cutting principle of childcare at all levels of the health system.

Health education and counselling on the disease and treatment adherence should be provided to patients on TB treatment (*strong recommendation, moderate certainty evidence*).

A package of treatment adherence interventions^a may be offered to patients on TB treatment in conjunction with the selection of a suitable treatment administration option ^b (*conditional recommendation, low certainty evidence*).

One or more of the following treatment adherence interventions (complementary and not mutually exclusive) may be offered to patients on TB treatment or to health care providers:

- tracers^c or digital medication monitor^d (*conditional recommendation, very low certainty evidence*);
- material support to the patient ^e (*conditional recommendation, moderate certainty evidence*);
- psychological support to the patient ^f (*conditional recommendation, low certainty evidence*);
- staff education^g (*conditional recommendation, low certainty evidence*).

The following treatment administration options may be offered to patients on TB treatment:

- Community- or home-based treatment support is recommended over health facility-based treatment support or unsupervised treatment (*conditional recommendation, moderate certainty evidence*).

- Treatment support administered by trained lay providers or health-care workers is recommended over treatment support administered by family members or unsupported treatment (*conditional recommendation, very low certainty evidence*).
- Video-supported treatment can replace treatment support when video communication technology is available and can be appropriately organized and operated by health care providers and patients (*conditional recommendation, very low certainty evidence*).

Patients with multidrug-resistant TB (MDR-TB) should be treated using mainly ambulatory care rather than models of care based principally on hospitalization (*conditional recommendation, very low certainty evidence*).

A decentralized model of care is recommended over a centralized model for patients on MDR-TB treatment (*conditional recommendation, very low certainty evidence*).

^a Treatment adherence interventions include social support such as patient education and counselling, material support (e.g. food, financial incentives, transport fees); psychological support; tracers such as home visits or digital health communication (e.g. SMS, telephone); medicine monitoring; and staff education. Interventions should be selected based on an assessment of the individual's needs, the provider's resources and conditions for implementation.

^b Suitable treatment administration options include various forms of treatment support, such as video-supported treatment and regular community of home based treatment support.

^c Tracers refer to communication with the patient, including via SMS, telephone (voice) or home visits.

^d A digital medication monitor is a device that can measure the time between openings of the pill box. The medication monitor may have audio reminders or send an SMS to remind patient to take medications, along with recording when the pill box is opened.

^e Material support can be food or financial support, such as meals, food baskets, food supplements, food vouchers, transport subsidies, living allowance, housing incentives or financial bonuses. This support addresses indirect costs incurred by patients or their attendants in order to access health services and, possibly, tries to mitigate consequences of income loss related to the disease.

^f Psychological support can be counselling sessions or peer-group support.

^g Staff education can be adherence education, charts or visual reminders, educational tools and desktop aids for decision-making and reminders.

Sources: WHO consolidated guidelines on tuberculosis. Module 5: management of tuberculosis in children and adolescents. Geneva: World Health Organization; 2022 (3); WHO Consolidated Guidelines on Tuberculosis. Module 4: treatment – drug-susceptible tuberculosis treatment, 2022 update. Geneva: World Health Organization; 2022 (87); WHO consolidated guidelines on tuberculosis. Module 4: treatment – drug-resistant tuberculosis treatment. Geneva: World Health Organization; 2020 (116).

6.2. Decentralized, family-centred, integrated TB services

Decentralization includes the provision of, access to or capacity for child and adolescent TB services at a lower level of the health system than the lowest level where it is currently routinely provided. In most settings, decentralization applies to the district hospital level (first referral level), PHC level or community level. Interventions to facilitate decentralization include capacity-building of various cadres of HCWs, access to diagnostic services, availability of TB medicines for children and adolescents, and follow-up of children and adolescents with TB or on TPT.

Since unwell children and adolescents commonly seek care at the PHC level, where TB services are not always available, decentralization and integration of such services using a family-centred approach has the potential to improve access to care, especially for children and adolescents who do not need referral to a higher-level facility. The objectives of decentralization are closely linked to the aspirations of universal health coverage (all people have access to the health services they need, when and where they need them, without financial hardship), which is a strategic priority for SDG target 3.8 (8).

Decentralization of care at the community level has the following advantages:

- increased equity via improved access to health services;
- provision of TB care at the same time and in the same place for all family members;
- savings in time and money when care is provided closer to home;
- continuity of care between the person's home, community and local health centre;
- increased community support, which may lead to better adherence to treatment and can be instrumental in overcoming barriers to long-term care, including treatment adherence, transportation costs, missing school, and loss of wages during sickness and clinic visits.

Other potential benefits of decentralization in the context of TB include increased treatment coverage in children and adolescents, reduced time to diagnosis and time to treatment, improved treatment success among children and adolescents started on TB treatment and TPT initiation, and reduced transmission (158–161).

6.2.1. Implementation considerations

For TB case detection and provision of TPT, the feasibility and effectiveness of decentralization and integration may vary by setting based on, for example, the local burden of TB disease, available resources, existing infrastructure, regulatory framework and structure of the NTP. The NTP should consider starting with an assessment of the feasibility and potential utility of decentralization or integration at different levels of care, or in urban versus rural settings, or in public versus private settings. During such an assessment, the NTP may consider the components listed below (among others).

In addition, site-level assessments may be conducted by health facility teams to assess readiness to deliver TB services. It may also be useful to conduct qualitative research on community needs and perceptions (including views related to stigma) and to collect suggestions for decentralization and integration of TB services, considering social, cultural and societal values.

6.2.1.1. Stakeholder engagement

The NTP could consider conducting stakeholder consultations (including relevant programmes such as maternal and child health, HIV and nutrition, national paediatric associations, other professional bodies and the national regulatory authority) to identify opportunities and strategies for decentralization and integration of services and to address health system challenges that might hamper implementation. This could be done through an existing child and adolescent TB technical working group or another relevant platform.

Such stakeholder consultations could also be convened as part of wider efforts to build and strengthen multi-sectoral engagement, actions and accountability to accelerate progress to end TB (162–164). As an example, to achieve universal access to child-friendly formulations, multisectoral engagement, actions and accountability are needed, including to establish supportive legal and regulatory mechanisms; encourage manufacturers to register products in countries or to include TB indications for repurposed medicines; update national guidelines and build capacity among HCWs and to establish effective procurement and supply chain mechanisms.

6.2.1.2. Regulatory framework and policy guidance

The availability of regulatory frameworks and policies that support the implementation of decentralized and integrated TB services is key to bringing TB services closer to children, adolescents and families and to creating and sustaining ownership and accountability at the national and subnational levels. The NTP, in partnership with other programmes, needs to review the existing health care structures and identify opportunities for decentralization and integration of TB services, or components thereof. Given the variation in country-specific settings, and the variety of settings within countries, the NTP should consider a flexible approach guided by the existing infrastructure, availability of resources

and disease burden – for example, decentralization of a single component of TB services versus a combination of components; phased implementation versus full-scale implementation; or operational research setting versus programmatic implementation. Some studies have shown that interventions delivered at the primary health facility and community levels (combined) have resulted in increased TB case notifications and TPT initiations compared with more centralized approaches (158–161, 165).

6.2.1.3. Health workforce

Availability of a skilled workforce at the various health care levels is critical to provide high-quality TB services. The NTP should plan for capacity building of staff to undertake any new responsibilities, including task-shifting for functions such as TB screening, contact investigation, non-invasive methods of sample collection, use of treatment decision algorithms, and use of child-friendly formulations of TB medicines. This can be achieved via training, provision of equipment, supportive supervision and mentorship.

Table 6.1 provides examples of the tasks related to health care providers at different levels of the health care system (6).

Table 6.1. Health care workers’ tasks at different levels of care

Level	Tasks
Primary care (e.g. health post)	<p>Provider-initiated identification of children and adolescents with symptoms and signs suggestive of TB</p> <p>Application of treatment decision algorithms with initiation of treatment for children with a treatment decision</p> <p>Specimen collection (using less invasive specimens where feasible and available) or referral</p> <p>Registration of all children and adolescents treated for TB or with TPT with district NTP office</p> <p>TB contact investigation to identify children and adolescents who:</p> <ul style="list-style-type: none"> • have symptoms and signs of TB and apply the relevant treatment decision algorithms or refer them to the first referral level of care as per national guidelines • have no symptoms and signs of TB and are eligible for TPT <p>Identification of source cases and screen close contacts for any child or adolescent diagnosed with TB</p> <p>Arranging follow-up for children and adolescents on TB treatment or TPT</p> <p>Referral of sick children (with danger signs) and adolescents to the first referral level of care as per national guidelines</p> <p>Referral in case of non-response to TB treatment</p> <p>Arranging patient- and family-centred care, including nutritional support, counselling on the disease, treatment adherence and treatment completion, and treatment support</p> <p>Provision of TB health education, including infection prevention, side-effects of TB medicines and what to do</p> <p>Provision of HIV counselling and testing</p> <p>Arranging follow-up for HIV-related care</p> <p>Addressing special needs of adolescents in terms of confidentiality, linkages to adolescent-friendly services and opportunities</p> <p>Establishment and maintenance of linkages with schools to enhance TB contact investigation and treatment support</p>

Level	Tasks
First referral (e.g. primary health centre)	<ul style="list-style-type: none"> Specimen collection (using less invasive specimens where feasible and available) Make a treatment decision using algorithms or diagnosis of TB disease or infection with <i>M. tuberculosis</i> Start treatment for TB and HIV when indicated Identify source case and screen close contacts for any child or adolescent diagnosed with TB Ensure registration of all children and adolescents treated for TB or with TPT with district NTP office Refer child or adolescent back to primary care level or appropriate HCW for ongoing treatment and follow-up Provide inpatient care as appropriate, including nutritional support Manage common side-effects Refer child or adolescent to second referral level in cases of severe or complicated TB Refer child or adolescent to second referral level in cases of diagnostic uncertainty Refer child or adolescent to second referral level in cases of treatment failure Refer child or adolescent to second referral level in cases of suspected MDR/RR-TB
Second referral (e.g. secondary or tertiary hospital)	<ul style="list-style-type: none"> Diagnose and manage complicated forms of TB, including most cases of disseminated TB, TBM and MDR/RR-TB in children and adolescents Identify source case and screen close contacts for any child or adolescent diagnosed with TB Advise NTP on management of people with complicated forms of TB Be part of the child and adolescent TB technical working group, contributing to guideline and training curriculum development Ensure registration of all children and adolescents treated for TB with district NTP office Refer child or adolescent back to primary or secondary care level or appropriate HCWs for ongoing treatment and follow-up

6.2.1.4. Treatment support

Implementation of the recommendations related to treatment support should enable the provision of people-centred TB services. Treatment adherence interventions that may be offered for people on TB treatment may include material support (e.g. food, financial incentives, transport fees), psychological support, tracers such as home visits or digital health communication (e.g. SMS, telephone) and medicine monitoring (107). Interventions should be selected based on assessment of the individual's needs and preferences as well as available resources. It is important to involve local schools, including educating teachers and other staff about TB, and providing accurate information about infectiousness, the needs of children and adolescents with TB or TB/HIV coinfection, the necessity for frequent visits to clinics, and the importance of taking medicines regularly. This may help to reduce stigma in schools and minimize time out of education. Faith-based organizations and other community groups can also be involved in supporting children and adolescents with TB and their families.

The following treatment administration options may be considered by the NTP where feasible:

- community- or home-based treatment support;
- treatment support administered by trained lay providers or HCWs;
- digital adherence platforms such as video-supported treatment.

6.2.1.5. Recording and reporting

Decentralization of health services requires decentralization of health information systems including capacity-building among staff responsible for data collection and analysis. The use of NTP recording tools (such as contact investigation, TPT and treatment registers) may need to be evaluated and enhanced, including through operational research.

6.2.1.6. Access to diagnostic supplies and child-friendly formulations of TB medicines

Health care facilities that offer TB services should have access to supplies for sample collection such as nasogastric tubes, spatulas and specimen containers, and access to child-friendly formulations of TB medicines. Sample referral systems need to be established if access to mWRDs is not available on site (76).

6.2.1.7. Resource requirements

Health system costs are likely to increase in initial phases of decentralizing services, but they are then expected to reduce over time. Initial investment costs may include costs related to infrastructure enhancement and capacity-building of health care providers and community engagement (See [web annex 4](#)). Recurring costs may include salaries, incentives, administrative costs, expanded information systems costs, and supervision and mentoring costs. Costs for patients and their families (e.g. for transport) may decrease.

[Table 6.2](#) summarizes aspects to consider when planning for the provision of decentralized, family-centred, integrated TB services. These services are in addition to (and do not replace) centralized or specialized TB services.

Table 6.2. Aspects to consider when planning for the provision of decentralized, family-centred, integrated TB services

Step	Description	Rationale
Health service delivery mapping and assessment	Map out health care levels and service delivery points where unwell children and adolescents seek care or are managed	Identify services or service components that can be decentralized or integrated and opportunities that can be leveraged to bring TB services closer to where children, adolescents and families live
	Map out health care levels and service delivery points where unwell children and adolescents with TB are managed	
	Assess services at different health system levels, including health facility and community level	Assess needs of health care facilities to implement TB services

Step	Description	Rationale
Stakeholder analysis	Map stakeholders engaged in TB service delivery, including for children and adolescents, and child and adolescent health at different levels of health care	Identify opportunities and strategies for engagement and collaboration Identify mechanisms for coordination and collaboration Identify platforms for advocacy Conduct stakeholder consultations (which can be linked to the development of a national multisectoral accountability framework)
Policy analysis and analysis of existing regulatory framework	Review existing regulatory framework and policy guidelines on TB and child and adolescent TB service delivery, child health and management of childhood illnesses (e.g. HIV, malnutrition, pneumonia), and adolescent health	Identify opportunities for decentralization and integration and update regulatory framework as needed Develop, adapt or update implementation guidelines, standard operating procedures and job aides
Human resources for health capacity assessment	Establish staffing norms and related tasks, roles and responsibilities Establish capacity of health care providers and training needs Develop training programmes	Identify capacity gaps Identify roles and tasks to decentralize or integrate Train or orient health care providers Implement supportive supervision Establish mentorship and coaching
Resource mapping	Map funding sources and gaps for prevention and management of TB in children and adolescents and child and adolescent health services at different health system levels	Identify funding opportunities Identify platforms for advocacy
Assessment of access to TB medicines, including child-friendly formulations and supplies	Assess availability of TB medicines and supplies, including child-friendly formulations, supplies (including supplies for non-invasive sample collection) Quantification	To inform procurement planning, budgeting and forecasting Provision of supplies and TB medicine, including child-friendly formulations
Health information management	Review existing recording and reporting tools Adapt electronic recording and reporting	Identify opportunities for data capture, reporting and use Promote or prioritize electronic recording and reporting Identify indicators for tracking progress and ensure data analysis is used to improve TB services

6.2.1.8. Opportunities for integration of TB services into other services

Opportunities for integration of TB services at the health facility level exist in outpatient departments; nutrition, HIV, maternal and child health clinics (e.g. prevention of mother-to-child transmission,

antenatal care, immunization clinics), general paediatric, adult TB and chest clinics; and inpatient departments. If resources are available, implementation of provider-initiated TB screening in relevant child health entry points and linkages to diagnosis or treatment may be considered by the NTP. If resources are limited, entry points or services designed to care for sick children could be prioritized.

The WHO policy on collaborative TB/HIV activities recommends the delivery of integrated TB/HIV services, preferably at the same time and location (167). The policy further recommends that HIV programmes and NTPs should collaborate with other programmes to ensure access to integrated and quality-assured services, including for children and adolescents. Quality statement 1.8 of the *Standards for improving the quality of care for children and young adolescents in health facilities* recommends that all children at risk for TB or HIV are correctly assessed and investigated and receive appropriate management according to WHO guidelines (168).

Many health care providers at the PHC level in high TB burden countries have been comprehensively trained on assessing and caring for children with pneumonia, diarrhoea and malnutrition using the IMCI and integrated community case management (iCCM) service delivery packages. These packages are centred around the most common childhood illnesses, such as pneumonia and malnutrition, which have a clinical presentation similar to TB (80, 169). Therefore, they offer an opportunity to strengthen integrated symptom-based screening for TB in sick children aged under 5 years. Specifically, the 2014 WHO IMCI chart booklet (80) caters for referral of children with a cough for more than 14 days; assessment of TB infection among children with acute malnutrition; and TB assessment and TPT among children living with HIV (80, 169).

Table 6.3 summarizes opportunities for integration of TB services.

Table 6.3. Opportunities for integrating TB services into other services

Target population	Opportunities	Actions required to enable delivery of TB services
Children	<ul style="list-style-type: none"> IMCI Immunization Nutrition Outpatient department Inpatient department iCCM Focused programmes for orphans and vulnerable children 	<ul style="list-style-type: none"> TB health education and counselling for HCWs Provider-initiated TB screening and linkages and referral to TB diagnosis and treatment HIV testing TB contact investigation TPT for eligible contacts and children and adolescents living with HIV Strengthening of recording and reporting systems and practices for TB data to reach NTP
Children and adolescents living with HIV	<ul style="list-style-type: none"> HIV and ART services Differentiated HIV service delivery 	<ul style="list-style-type: none"> TB health education and counselling Provider-initiated TB screening TB diagnosis and treatment TB contact investigation TPT for eligible contacts and children and adolescents living with HIV Psychosocial support Strengthening of recording and reporting system and practices for TB data to reach NTP

Target population	Opportunities	Actions required to enable delivery of TB services
Adolescents, girls and young women	Adolescent-friendly services Family planning services HIV and ART services Outreach programmes	TB health education and counselling Provider-initiated TB screening and linkages to TB diagnosis and treatment HIV testing TB contact investigation Psychosocial support Strengthening of recording and reporting system and practices for TB data to reach NTP
Pregnant women	Antenatal care services Prevention of mother-to-child transmission	TB health education and counselling Provider-initiated TB screening and linkages to TB diagnosis and treatment HIV testing TB contact investigation Psychosocial support Strengthening of recording and reporting systems and practices for TB data to reach NTP
Postnatal women	Postnatal care services Prevention of mother-to-child transmission Mother and baby care points	TB health education and counselling Provider-initiated TB screening and linkages to TB diagnosis and treatment HIV testing Psychosocial support TB contact investigation TPT for eligible postnatal women Strengthening of recording and reporting systems and practices for TB data to reach NTP

6.2.1.9. Socioeconomic impact of TB on children, adolescents and families

TB commonly affects people of lower socioeconomic status and exacerbates poverty and social deprivation through catastrophic costs²⁵ and reduced household income. Most children with TB develop TB after contact with an adult family member with infectious PTB. A high number of TB notifications in children indicates an ongoing adult epidemic (170). TB in the family unit does not only result in transmission to children: it also poses a threat to household income and financial security. Some examples of the impact of TB on children include dropping out of school following parental bereavement from TB or to work to maintain household income (171). TB in childhood or adolescence may disrupt or delay schooling and impair growth (172).

As part of the process of developing the consolidated guidelines on the management of TB in children and adolescents, a conceptual framework was developed that outlined the pathways and mechanisms

²⁵ The operational definition of “catastrophic costs as a result of TB” refers to medical and non-medical out-of-pocket payments and indirect costs exceeding a given threshold (e.g. 20%) of the household’s income. Medical costs refer to the sum of out-of-pocket payments for TB diagnosis and treatment made by people with TB in a given household. Non-medical out-of-pocket costs are payments related to the use of TB health services, such as payments for transportation, accommodation or food. Both costs are net of any reimbursements to the individual who made the payments. Indirect costs refer to patient or guardian lost time, lost wages (net of welfare payments) and lost income due to TB health-care seeking and hospitalization during the TB episode.

that most plausibly explain the socioeconomic impact of TB on children and adolescents (Atkins S, Heimo L, Carter D et al., unpublished data, 2022).

In this framework material, educational and psychosocial impacts contributed to in child impoverishment; missed educational opportunities; reduced physical, intellectual and emotional growth; and poor mental health.

An associated scoping review reported that time spent caring for a child with TB impacted on family spending, nutrition and education, and overall reduced household income, all of which were associated with lowered family well-being. TB impacted on children's education, particularly when the affected family member was male and the primary breadwinner, sometimes with inter-generational consequences. Hospitalization and other aspects of TB treatment, including directly observed treatment, impacted on school attendance. In addition, perceived and enacted stigma had practical implications for TB diagnosis, clinic attendance and treatment, and other psychosocial impacts beyond stigma, including breakdown of parental relationships were reported.

In addition to the scoping review, an analysis of data from 10 national TB patient cost surveys was undertaken, including almost 1500 children and adolescents. National patient cost surveys are not usually designed or powered to detect the proportion of children and adolescents with catastrophic costs, but the findings from these analyses provided useful additional insights into the consequences of a TB diagnosis for children and adolescents. Overall, if the person with TB was a child or adolescent, the proportion of households that experienced catastrophic costs was lower (41.8%, 95% CI 22.9–60.8%) than if the person was an adult (56.2%, 95% CI 44.4–68.1%).

School disruption was one of the major consequences among children (8.4%, 95% CI 3.4–13.4%) and adolescents (18.7%, 95% CI 8.8–28.7%) with TB. Food insecurity was experienced by 19.8% (95% CI 3.7–35.8%) of children with TB and 20.5% (95% CI 11.5–29.8%) of adolescents with TB. Households had little access to social protection during TB treatment. In households where the person with TB was a child, a pooled average of 7.9% (95% CI 1.9–14.0%) had access to social protection; for adolescents, this figure was 12.0% (95% CI 2.2–21.9%).

These findings emphasize the need for social protection for children and adolescents with TB. In addition, based on identified needs, a family-centred approach to social protection may be used. Education, food insecurity and social protection are multisectoral issues that require strong linkages with programmes in other sectors as they strive for comprehensive TB care.

Based on the findings of the scoping review, the following steps may help mitigate and better understand the socioeconomic impact of TB on children and adolescents, including:

- models of care and treatment adherence strategies that are family- and child-friendly and that have fewer socioeconomic consequences, while still facilitating treatment completion and maintaining a supportive environment for treatment overall;
- family-centred models of care for the design of strategies and policies to mitigate the direct and indirect effects of TB on children and adolescents;
- additional complementary research to evaluate the socioeconomic impact of TB care for children and adolescents and the effect of social protection and other mitigation strategies.

6.2.1.10. Examples of country experiences in development of family-centred, decentralized and integrated TB services for children and adolescents

Box 6.3 Finding the missing children affected by TB: preliminary data from the Catalyzing Pediatric Tuberculosis Innovation project experience in sub-Saharan African countries (unpublished data, 2021)

Countries Cameroon, Côte d'Ivoire, Democratic Republic of Congo, Kenya, Lesotho, Malawi, Uganda, United Republic of Tanzania, Zimbabwe

Period 2018–2021

Target population Children and adolescents aged under 15 years

As of June 2021, the intervention was implemented in 359 facilities across 9 countries. Consistent with the project's aim of decentralizing capacity to diagnose and manage paediatric TB to lower-tier facilities, the distribution of facilities enrolled in the project was as follows: 69% were level 1 facilities (health centres, dispensaries), 28% level 2 (district hospitals) and 3% level 3 (regional or national hospitals).

The project implemented a multipronged case-finding intervention, which was introduced across sites in a phased manner. This included:

- introduction of systematic TB screening in entry points attended by children, using a child-adapted screening tool to assess signs, symptoms and risk factors associated with paediatric TB;
- delivery to facility personnel of comprehensive training on paediatric TB diagnosis and management, including support for clinical diagnosis of childhood TB;
- implementation of sample collection procedures (gastric aspiration, NPA, induced sputum, lymph node biopsy by fine-needle aspiration) and support for sample transportation to Xpert MTB/RIF testing sites where needed;
- improved access to CXR whenever possible (e.g. transport vouchers, subsidies for CXR fees, radiologist consultants supporting interpretation of CXR);
- intensified household contact investigation, including facility- and community-based approaches.

Results Between December 2018 and June 2021, 3 424 043 children and adolescents aged 0–14 years were screened for TB through project interventions. A total of 50 010 were identified as presumptive TB and 9845 were diagnosed with TB. Among the 9845 diagnosed with TB, 49.8% (4902) were aged 0–4 years, 50.1% (4931) were aged 4–15 years and 0.1% (12) were of unknown age. The average monthly rate of children diagnosed per site increased from 1.37 before the intervention to 1.93 after the intervention, showing a significant 1.4-fold increase ($P < 0.0001$). The average proportion of children diagnosed with bacteriologically confirmed TB increased from 14.1% before the intervention to 22.4% after intervention, showing a 1.59-fold increase ($p < 0.0001$).

Of the 9845 children and adolescents diagnosed with TB, 90% (8813) were identified through facility-based case-finding interventions and 10% (1032) through contact investigation activities (facility-based or community-based).

Lessons learnt: Implementation of the CaP-TB multipronged case-finding approach is feasible across different levels of the health care system, including at the primary level. The majority of children with TB were identified through the introduction of systematic TB screening in various facility non-TB entry points or services attended by children (e.g. outpatient department, inpatient department, mother and child health, nutrition, HIV). Task-shifting of paediatric TB screening to lay HCWs was feasible and well accepted by HCWs and facility managers. It is critical for NTPs to map pathways followed for sick children at the facility level and to ensure capacity and confidence to recognize and manage paediatric TB are effectively integrated into all services attended by sick children. The delivery of a strong programme for training, support and supervision for paediatric TB targeting frontline HCWs was critical to building the capacity and confidence needed to diagnose and manage paediatric TB across child services, including at the primary level.

Box 6.4 TB-Speed project: strengthening paediatric TB services for enhanced early detection (unpublished data, 2021)

Countries Cambodia, Cameroon, Côte d'Ivoire, Mozambique, Sierra Leone, Uganda

Setting 2 district hospitals and 9 or 10 PHC facilities per country

Period Ongoing

Target population Sick children and young adolescents aged under 15 years attending for care at the district hospital or PHC level (outpatient department entry); and children aged under 15 years with presumptive TB identified through systematic TB screening or routine clinical assessment at the district hospital or PHC level

Interventions implemented Patient-level interventions were:

- systematic TB screening;
- clinical evaluation;
- Xpert Ultra testing of NPA and stool (or expectorated sputum);
- optimized CXR reading, using digital radiography, improvement of reading skills, simplified reading tools, and quality control of reading;
- treatment decisions.

Health system-level interventions were:

- district hospital-focused decentralization strategy – patient care-level childhood TB diagnostic approach at the district hospital level (PHC in this district conducts systematic TB screening and refers to district hospital);
- PHC-focused decentralization strategy – patient care-level childhood TB diagnostic approach at the PHC level (includes systematic TB screening, clinical evaluation, and testing of NPA and stool or expectorated sputum with Ultra). The district hospitals in the districts implementing the PHC decentralization strategy also implement the patient care-level diagnostic approach for children screened with presumptive TB at the district hospital level.

Implementers at the health facility level gave the following feedback:

- Systematic screening was perceived as important and useful but not easy to implement, especially at the district hospital level (workload, flow of patients). Screening questions were sometimes complex for parents to understand, especially when asked in crowded waiting areas and in contexts where there is stigma associated with TB.
- Stool collection and NPA using a battery-operated mucus aspirator system were feasible and well accepted at the district hospital and PHC levels. NPA collection usually required the involvement of at least two people (HCW and a colleague or the child's parent). Stool was frequently not obtained while the child was at the facility (or later due to transport and financial constraints for parents to travel back with stool containers).
- Xpert Ultra testing using the battery-operated GeneXpert Edge platform was implemented in all PHC facilities of the six countries, and stool samples were tested at district hospital level. Poor sample transport conditions between facilities (distance, terrain, heavy rain, challenges in maintaining storage temperature) and power instability at district hospital and PHC levels impacted on stool sample testing.
- CXR digitization and transfer of images for clinicians to access them was a challenge in several countries, especially for clinicians at PHC level, due to poor internet connectivity.
- Both decentralization models faced structural and organizational constraints, mainly in terms of availability, stability and motivation of human resources (rotation and transfer were frequent; incentives for additional workload were required).
- Supportive supervision contributed to addressing many of the operational challenges. Clinical mentoring provided clinicians with increased confidence in clinical and CXR reading skills for TB diagnosis.

Box 6.5 The DEcentralise TB services and Engage Communities to Transform lives of Children with TB project (158)

Country Uganda

Setting Two districts (one rural, one peri-urban)

Period 2015–2016

Implemented by the Union Against TB and Lung Disease in collaboration with the National Tuberculosis and Leprosy Programme, Baylor-Uganda and Mildmay-Uganda

Interventions implemented The project focused on decentralization health care services for the management of TB in children from tertiary to PHC facilities and establishing linkages to support community-based household contact screening and management.

The following activities were implemented:

- baseline data collection for the project districts;
- stakeholder engagement meetings at the national (including paediatric TB technical working group) and district levels;
- development of a training package adapted to the local context from the *Union's desk guide* (73) and online child TB training course in collaboration with the NTP;
- training of facility and community teams via a cascade approach:

- district-level trainers were trained in management of TB in children; these trainers then trained frontline health workers at the PHC level via a 2-day didactic training, enhanced with case studies from the Union's online childhood TB course;
 - CHWs identified by the community and linked to a health facility were trained to perform screening of household contacts of people with bacteriologically confirmed TB; to identify and refer symptomatic contacts of any age for further evaluation; to refer asymptomatic young child (aged under 5 years) contacts to health facilities for initiation of TPT; and to provide families with health education and TPT adherence support;
- post-training mentorship and supportive supervision conducted monthly for the first 3 months after training and then quarterly;
- health systems support and strengthening via repair of faulty microscopes, retraining laboratory personnel, supply chain management training for health facility staff, and procurement of additional supplies for isoniazid.

Data review driven by quality improvement was conducted every quarter to review facility and community performance via district meetings and community linkage meetings. These platforms provided an opportunity to identify challenges and share best practices.

The study showed that diagnosis (including clinical diagnosis) and treatment of TB in children can be achieved at the PHC level. Stakeholder engagement (including the NTP) and resources are pivotal for sustainability and scalability such as skilled personnel, training tools and financial support. CHWs can be engaged successfully to provide integrated care for household contacts of TB cases, including detection and referral of symptomatic child contacts. Linkages of household contacts with primary care facilities through CHWs can achieve high rates of uptake and completion of TPT.

TB case-finding and treatment			
Indicator	Result	Baseline	End of intervention
Proportion of all diagnosed child TB cases by health facility level	Increase in child TB case notification at PHC level	96% at level V 3% at level IV 1% at level III	50% at level V 21% at level IV 29% at level III
Caseload of child TB and as proportion of total TB notifications	139% increase	8.8% (271)	14.9% (647)
Cases of TB in young children, proportion of all child TB cases	Increase in children aged <5 years	36.5% (99)	50.1% (324)
Cases of TB in older adolescents and adults	32% increase	Baseline: 2805	Implementation: 3693
Treatment success (cure and complete)	Significant improvement	Baseline: 65%	Implementation: 81%
Died or treatment failure	Reduction in poor outcomes	Baseline: 15%	Implementation: 4%
TPT			
Indicator	Result	End of intervention	
Eligible child contacts who initiated IPT	Increase in uptake	77% (670 of 910 eligible)	
Child contacts who completed IPT	Increase in IPT completion rates =	85% (569 of 670 who commenced IPT)	

Box 6.6 Childhood TB integration into integrated management of newborn and childhood illness in health facilities of Addis Ababa (173)

Country Ethiopia

Setting High TB burden country

Period 2016–2017

Implemented as a collaboration between the Addis Ababa City Administration Health Bureau, the federal Ministry of Health and national TB programme and the USAID-funded Challenge TB project

The intervention package included the incorporation of a TB case management flowchart in the national integrated management of newborn and childhood illness (IMNCI) chart booklet, the addition of a TB screening column in the IMNCI treatment register, and sensitization training on paediatric TB for child health and TB programme officers, health extension supervisors and facility administrators from 30 selected health facilities. A paediatric TB desk reference, contact investigation and preventive treatment registers, and an updated IMNCI register were supplied. On-site coaching was provided on specimen collection using nasogastric aspiration techniques. Monitoring of implementation was conducted monthly and quarterly, and periodic performance review meetings were held.

Services for childhood TB including sample collection (nasogastric aspiration) can be decentralized to the PHC level using IMNCI platforms with additional intervention packages. Creating awareness and counselling on the benefits of IPT and management of side-effects of medicines can increase IPT uptake. Strengthening linkages between health facilities and the community through existing platforms is crucial for creating awareness on TB, contact investigation, tracing people who interrupt treatment and adherence counselling.

Indicator	Result	Baseline	End of intervention
Proportion of children screened for TB at under-5 clinics	Increased	28.3% (4812)	98% (31 590)
Proportion of identified presumptive TB cases	Increased	0.06% (3)	0.33% (257)
TB cases in children aged <5 years	Increased	1	50 (including 30 via IMNCI, 8 via contact investigation)
Gastric aspiration procedures	Acquired skill	0	109
TB screening of contacts	Increased	46%	100%
Proportion of eligible contacts aged <5 years started on TPT	Increased	11.3% (16)	73.7% (207)

In conclusion, the implementation of decentralized, integrated patient- and family-centred care and prevention improves access to health services and can potentially lead to increases in TB case notifications and case detection rates in children and adolescents, reduced time to diagnosis (and time to treatment), improved treatment success among children and adolescents started on TB treatment and TPT initiation, and improved rates of treatment completion.

6.3. Private-sector involvement in care for children and adolescents with TB

6.3.1. Background

In many high TB burden countries, the majority of missing people with TB, including children, seek treatment from private providers or other care providers not linked to the public sector at least once (174). The private sector is also a common point of care for children presenting with common illnesses, such as cough, fever and diarrhoea, especially in countries with a large private sector (175). In these countries, people with or at risk of TB are unlikely to access good-quality TB services if the NTP does not comprehensively engage the private sector.

The 2018 WHO *Roadmap towards ending TB in children and adolescents* prioritizes the need to foster functional partnerships to optimize TB care, including with the private sector (5). The private health care sector provides an entry point to TB care and treatment, including for children, adolescents and their families (174–176). This implies that NTPs should engage both the public and private health sectors, especially as countries intensify efforts towards achieving universal health coverage.

6.3.2. Rationale

In most low- and middle-income countries, private providers are an important source of health care for the whole population. Typically, less poor people make more use of formal, qualified providers, while poor people often turn first to informal, unqualified providers. Private providers often account for 50–70% of care, especially outpatient primary care (175). In 7 of the 30 high TB burden countries, which also contribute to the largest proportion of TB incidence and missing TB cases, the private sector is the first point of contact for up to 75% of people seeking care (174, 176). In many high TB burden countries, especially those with a large private health sector, engagement of private providers has systematically increased, and there is a need to strengthen the engagement of all care providers, building on evidence from country experiences and initiatives that demonstrate increased case detection and good treatment outcomes through approaches that engage the private sector (175). Health care providers in the private sector may not be provided with information or trained in TB with up-to-date guidance on TB diagnosis and treatment, including the use of child-friendly formulations, and children and adolescents managed in private facilities and services are often not notified to the NTP.

6.3.3. Benefits of involving the private sector in TB care

Engaging health care providers within the private sector aims to improve access to TB care and treatment for people who prefer to seek care within the private setting, including children and adolescents (174).

This approach may save patients money by facilitating referral to free NTP services or enabling privately managed patients to benefit from programme-procured medicines, diagnostics and social support. Engaging private health care providers has the advantage of relieving the NTP of some roles and responsibilities in TB care and treatment, such as awareness creation, TB prevention, systematic TB screening, diagnosis, treatment initiation and follow-up, TB transmission due to diagnosis and treatment delays, mortality and morbidity due to inappropriate treatment, drug resistance due to incomplete treatment, catastrophic costs due to out-of-pocket expenditure, and incomplete monitoring and evaluation of TB services. Furthermore, it can address challenges around delayed and incomplete introduction of improved TB tools and commodities, including FDCs, as a result of failure to penetrate private channels (174).

6.3.4. Implementation considerations

A wide range of private health care providers exist in different settings, and the services they provide vary. It is important for NTPs to map the different private health care providers in their settings and implement flexible models of engagement guided by the scope of services they provide. The 2018 WHO *Roadmap towards ending TB in children and adolescents* highlights the need to train private health care providers in child and adolescent TB, including systematic TB screening, sensitize them on the importance of mandatory reporting, and inform them about the child-friendly formulations available for TB treatment (5).

The 2018 WHO *Public–private mix for TB prevention and care: a roadmap* outlines 10 key actions for successful engagement of the private sector (Box 6.7). These actions can be used by NTPs to guide private-sector involvement as a model of care for TB care and treatment in children and adolescents (174).

Box 6.7 Key actions applied to child and adolescent TB services from the WHO Public–private mix for TB prevention and care: a roadmap

Key action 1 Build understanding about patient preferences, private-sector dynamics and the rationale for engaging all care providers. This is particularly important in providing information that will be used to guide prioritization of providers to engage such as paediatricians in private practice. For example, what type of provider are sick children and adolescents taken to? Do children and adolescents go to public or private providers? What diagnosis and treatment services are offered by different providers? Are the services affordable?

Key action 2 Set appropriately ambitious public–private mix targets. The targets should incorporate aspects of child and adolescent TB to enhance focused attention while emphasizing private-sector contributions towards reducing the gap in TB treatment and preventive treatment coverage.

Key action 3 Advocate for political commitment, action and investment in the public–private mix. Advocacy plays a critical role in establishing the foundation for sustained engagement of all providers and should integrate components of child and adolescent TB.

Key action 4 Allocate adequate funding to engage all providers, including by capitalizing on financing reforms for universal health coverage. As NTPs prioritize private engagement within budget allocations and expenditure, they should ensure aspects of child and adolescent TB are reflected.

Key action 5 Partner with and build capacity of intermediaries and key stakeholders. Intermediary agencies play a major role in bridging the gap between the NTP and private providers, especially since private health providers commonly focus on clinical management versus other public health interventions such as TB contact investigation. Professional bodies such as paediatric associations can act as intermediaries between the NTP and the private sector. Professional bodies can be engaged to support the implementation of critical activities such as dissemination of child and adolescent TB guidelines, training, mentorship and supervision. Paediatricians can particularly support capacity-building efforts to enhance competencies in clinical diagnosis and sample collection.

Key action 6 Establish a supportive policy and regulatory framework. The NTP should ensure aspects of child and adolescent TB are integrated into these strategic documents. The patient-initiated pathway to TB diagnosis can be enhanced by improving access to care, including reducing direct and indirect costs to children, adolescents and their caregivers associated with seeking care and addressing the specific needs of vulnerable groups by strengthening PHC services, extending diagnostic and testing services, and providing social protection schemes where possible and necessary.

Key action 7 Adapt flexible models of engagement applicable to local contexts because of the diversity in the health market. This is particularly important to note as standardization in PPM would limit scale and effectiveness.

Key action 8 Harness the power of digital technologies. Standard NTP recording and reporting tools, especially paper-based tools, may hinder timely and accurate reporting from the private sector, including of child and adolescent TB data. There may be only limited staff, who do not have the time to complete such tools, and there may be a lack of proper systems to support the required reporting. Introduction of digital technologies provides an opportunity for the NTP to capture finer age-disaggregated data from the private sector and use the data to make decisions.

Key action 9 Deliver a range of financial and nonfinancial incentives and enablers. Well-designed incentives and enablers can help motivate care providers to engage in TB prevention and care.

Key action 10 Monitor progress and build accountability. Continuous monitoring and evaluation of the contributions of PPM, in relation to the specific objectives and targets set by the NTP are critical in enhancing sustainability and accountability. The NTP should ensure aspects of child and adolescent TB are included in the monitoring and evaluation framework.

Engagement of the private sector via a combination of interventions such as awareness campaigns, community screening by lay providers, use of digital technology and provision of incentives led to a two-fold increase in TB case notifications in Pakistan. In this project, a 7.3-fold increase was documented for PTB notifications among children, highlighting the role of private-sector engagement in TB management for children (166).

Box 6.8 The Catalyzing Pediatric Tuberculosis Innovation project: enabling access to public paediatric TB medicines for private-sector patients in India – translating policy into action

Country India

Setting Private sector

Period 2018–2021

Target population Children and adolescents aged under 15 years

Interventions implemented The Unitaid funded CaP-TB project aimed to improve the quality of TB care in the private sector, including the prescription and uptake of standardized public FDCs. To realize this goal, Solidarity and Action Against the HIV Infection in India (SAATHII) advocated with private providers qualified to practise allopathic medicine and facilitated access to medicines by linking them with the National Tuberculosis Elimination Programme or provided them directly.

In partnership with the Indian Academy of Pediatrics and the National Tuberculosis Elimination Programme, CaP-TB conducted training and continuing medical education workshops.

In India, patients must be registered on the Nikshay portal to receive TB medicines at public facilities.²⁶ This can be done by National Tuberculosis Elimination Programme staff, private providers, patients or provider support agency staff. CaP-TB project staff (one in each district) notified paediatric TB cases when private paediatric facilities informed them about new cases. In addition, the project registered 1065 private facilities on the portal to enable notification by providers.

Public health facilities stock TB medicines based on estimated caseload. Due to low numbers of cases, paediatric medicines may not always be available in sufficient quantities at primary health centres. To address this, when informed about a child with TB, CaP-TB field staff shared the child's name and address with the district senior treatment supervisor at the subdistrict level. Subsequently, the senior treatment supervisor would ensure the availability of medicines at the child's local public health facility within 1–2 days.

In rural and some urban areas, TB medicines were delivered to patients' homes by frontline health workers (accredited social health activists or TB health visitors) or a local nongovernmental organization engaged as a patient provider support agency.

Results Between August 2018 and June 2021, the project linked more than 1100 children and adolescents aged under 15 years with TB to public FDCs. The proportion of children and adolescents aged under 15 years with TB diagnosed at CaP-TB-supported sites treated with government FDCs subsequently increased from 29% to 65%.

Providers who have changed their practices and now prefer to prescribe public FDCs cited the ease of prescription due to their availability as per weight bands, and the benefit to patients in terms of reduced expenditure. Several providers were also satisfied with the regularity of government supply and the support provided through CaP-TB to provide medicines when patients faced problems with supply.

Challenges Generally, caregivers were able to get medicines at public facilities within a day of diagnosis. Treatment initiation was delayed in certain cases, however, when medicines had to be delivered to the patient's local public facility from a district- or subdistrict-level facility, or if the senior treatment supervisor was unavailable to verify Nikshay registration.

Public pharmacy opening times may be inconvenient for caregivers, especially if collection leads to loss of income. The pill burden for children in higher weight bands seemed excessive to some caregivers.

Providers who continue to prescribe private-sector FDCs reported doing so because they had favourable outcomes with them in the past. One provider voiced doubts about the quality and efficacy of public-sector FDCs. Another challenge cited by providers was that referring patients to the public services makes follow-up difficult since patients do not have to return to the private facility for medicine refills. Patient preferences for private-sector medicines and privacy concerns were also cited as a key reason for care-seeking in the private sector and for prescribing private-sector medicines.

²⁶ Nikshay is the web-enabled patient management system for TB control under the National Tuberculosis Elimination Program.

6.4. Differentiated TB service delivery

6.4.1. Background

The concept of DSD (previously referred to as differentiated care) is increasingly being applied during the provision of comprehensive HIV services (78). In the context of HIV, DSD is a people-centred approach that simplifies and adapts HIV services to better serve the needs of people living with HIV and to optimize the available resources in health systems. DSD is premised on the fact that delivery of services is not a one-size-fits-all model but rather recognizes the diversity of people who seek the services. It is designed to efficiently deliver people-centred packages of health care and can be particularly effective in caring for people with chronic diseases.

The principles of DSD are applied to the HIV care cascade, including prevention, testing, linkages to care, ART initiation and follow-up, and integration of HIV care, coinfections and comorbidities. Since TB is a chronic disease and among the HIV-associated comorbidities, the DSD approach can be considered as a care model through which implementation of patient-centred care is enhanced.

- DSD is an approach that simplifies and adapts HIV services to better serve the needs of people living with HIV and to optimize the available resources in health systems.
- People-centred care is care focused on and organized around the health needs and expectations of people and communities rather than diseases.

6.4.2. Rationale

Countries may have DSD policies in place, but children, adolescents and people living with HIV-associated TB are often excluded. DSD has primarily focused on people living with HIV who are established on ART (79). It is therefore important that the NTP works closely with the national HIV programme to ensure children and adolescents are able to access these patient-centred approaches.

6.4.3. Implementation considerations

Generally, integration of TB care and treatment into DSD models requires adaptations at multiple levels of the health system, including national, facility and community levels (177). This includes enhancement of leadership and coordination, adaptation of guidelines, capacity-building, adjustments in logistics management, alignment of existing recording and reporting tools, and community engagement. Other factors to consider include the local burden of HIV and TB disease, existing infrastructure and human resources.

The *WHO policy on collaborative TB/HIV activities* recommends the delivery of integrated TB and HIV services, preferably at the same time and location, to improve access to good-quality services (167). Advances in HIV care and treatment towards the provision of differentiated services imply that NTPs must work closely with HIV programmes to ensure TB services are integrated into all the DSD models of care.

DSD models for HIV treatment are described within one of the following four categories:

- group models managed by HCWs;
- group models managed by clients;
- individual models based at facilities;
- individual models not based at facilities.

This implies there is a need to enhance capacity for provision of TB services within DSD models, such as training, mentorship and supportive supervision. Client-driven DSD models allow for task-shifting, and it is important for NTPs to clearly map out the tasks that can be provided by lay providers within the DSD model.

DSD for HIV treatment aims to separate clinical consultations from other visits, such as for ART refills or psychosocial support. Such components need to be taken into consideration as TB services are being provided for within the DSD models. DSD models such as multimonth dispensing of ART would require adjustments in dispensing of TB or TPT medicines, including for children and adolescents, to ensure alignment with medicine refills. Adherence support mechanisms and platforms, including digital adherence technologies, to monitor adverse events of ART can be leveraged to enhance TB treatment completion. Family-centred models for ART that include children and their parents or caregivers can also incorporate TPT and may improve clinical outcomes for the entire family and reduce unnecessary travel and costs.

TB treatment follow-up processes such as weight monitoring to guide dose adjustments are critical and should be catered for. On the other hand, the multimonth dispensing approach may require fewer visits to service delivery points, which may translate into fewer opportunities for TB screening or reduced quality of TB screening. Similarly, failure to align TB and HIV services within the models may lead to treatment interruption resulting from complex follow-up schedules. Data capture and reporting mechanisms for TB care processes and outcomes, especially within the models that are not managed by health workers and those not based at the health facility, are important.

Box 6.9 Stable 1-year-old child with an antiretroviral therapy plan consisting of clinic visits every 2 months

A 1-year-old child living with HIV stable on ART has clinic visits scheduled every 2 months for medicines (purple solid bars) and check-ups. The child is a household contact of a caregiver diagnosed with TB, so the provider initiates TPT (6 months of isoniazid) at the child's ART clinic visit. This ART clinic visit is combined with a TB diagnostic evaluation to rule out TB disease and to provide standardized education about TPT and potential side-effects. The caregiver is given 2 months of isoniazid (solid orange bars), which is enough to last until the child's 2-month ART clinic visit.

At the child's 2-month ART clinic visit, a TPT assessment is combined with the visit to check for breakthrough TB and to ensure the child is taking their medicines consistently. An additional 2 months of isoniazid is provided at this visit.

At the child's 4-month ART clinic visit, a TPT assessment is combined with the visit to check for breakthrough TB and to ensure the child is taking their medicines consistently. An additional 2 months of isoniazid is provided at this visit.

At the child's 6-month ART clinic visit, the child is evaluated and documented to have completed TPT.

The caregiver receives weekly treatment support (striped orange bars) from a CHW through SMS messaging throughout the 6 months.

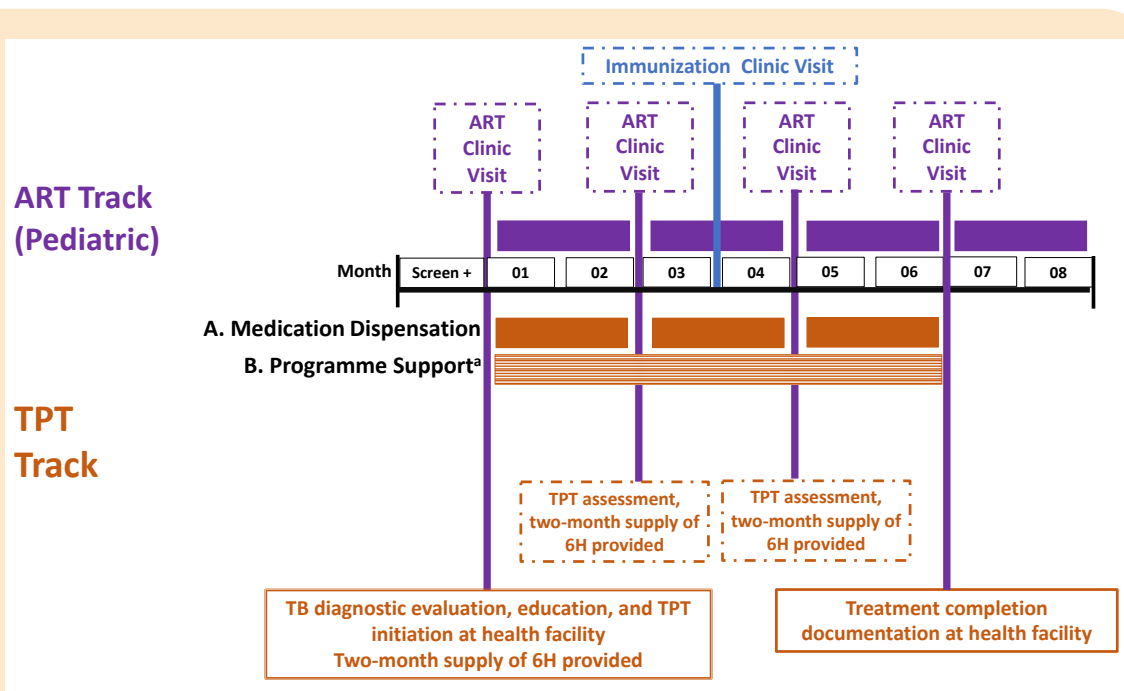

^a Programme support includes adherence support and screening for TB and adverse events, which should be provided at least monthly. This support can be provided virtually or in the community, or as a combination of these, to maintain the DSD model and reduce contact with the health facility. This support should be in addition to the clinical assessment that occurs during in-person clinic visits.

TPT assessment consists of evaluating for breakthrough TB, checking the child's weight, assessing TPT-related adverse events, providing adherence counselling, and adjusting the TPT dose based on weight change if needed. The figure defines the elements of the model and their timing.

Solid coloured bars represent the duration for which medicines are dispensed at the previous clinic visit. Solid purple bars represent the duration for which ART has been dispensed. Solid orange bars represent the duration for which TPT has been dispensed.

There are flexibilities inherent in this model regarding who carries out each task and in what setting. For example, dispensing of medicines could occur at the clinic, pharmacy or community distribution point.

Source: Tool 17b in: PEPFAR solutions platform – TB Preventive Treatment (TPT) Implementation Tools (<https://www.pepfarsolutions.org/resourcesandtools-2/2018/9/25/tpt-implementation-tools>).

Box 6.10 Stable 15-year-old adolescent with an antiretroviral therapy plan consisting of clinic visits every 6 months

A 15-year-old adolescent living with HIV is stable on ART, with ART clinic visits scheduled every 6 months for medicines (purple solid bar) and check-ups. The adolescent is initiated on TPT (6 months of isoniazid) at an ART clinic visit. This visit was combined with a TB diagnostic evaluation to rule out TB disease and to provide standardized education about TPT and potential side-effects. The adolescent is given 6 months of TPT (orange solid bar) to last until their next ART clinic visit.

At the adolescent's 6-month ART clinic visit, the adolescent is evaluated and documented to have completed TPT.

The adolescent receives treatment support (striped orange bar) from monthly CHW visits throughout the 6 months.

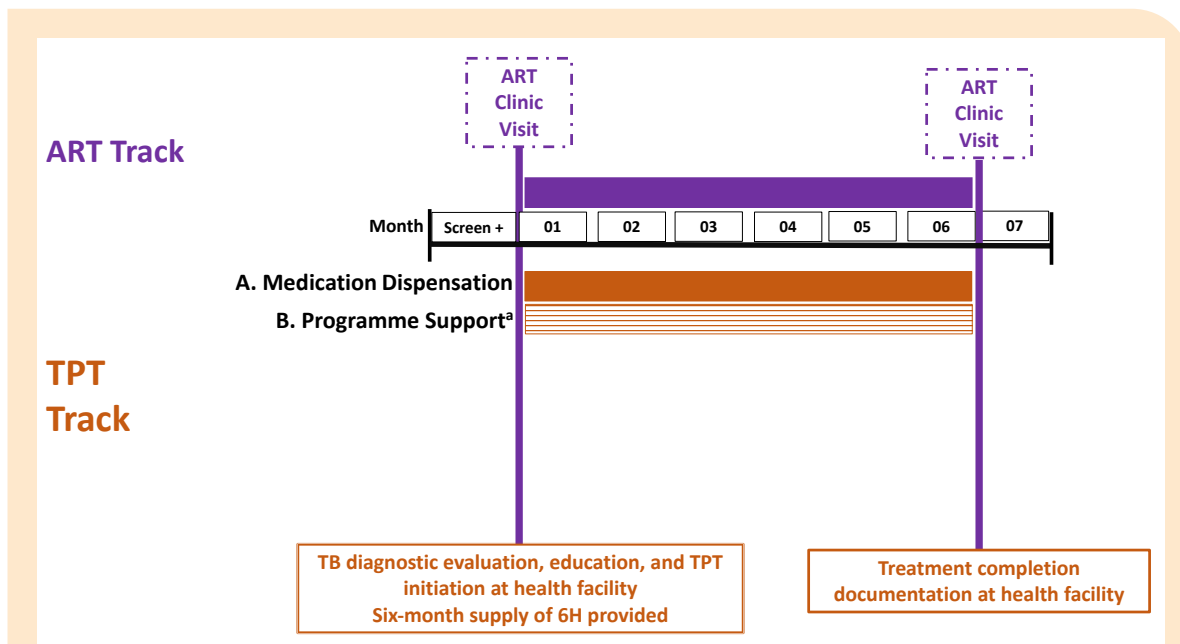

^a Programme support includes adherence support and screening for TB and adverse events and should be provided at least monthly. This support can be provided virtually or in the community, or as a combination of these, to maintain the DSD model and reduce contact with the health facility. This support should be in addition to the clinical assessment that occurs during in-person clinic visits.

Note that among stable adolescents, two clinic visits a year, spaced 6 months apart, provide sufficient opportunity to assess weight and adjust dosages (182). There are flexibilities inherent in this model with regard to who carries out each task and in what setting.

Source: Tool 17b in: PEPFAR solutions platform – TB Preventive Treatment (TPT) Implementation Tools (<https://www.pepfarsolutions.org/resourcesandtools-2/2018/9/25/tpt-implementation-tools>).

Box 6.11 HIV-negative 4-year-old child in close contact with caregiver living with HIV recently diagnosed with TB

A child is a household contact of a caregiver living with HIV and diagnosed with TB. The provider initiates TPT (3 months of daily isoniazid and rifampicin, 3HR) at the child's clinic visit. This clinic visit consists of a TB diagnostic evaluation to rule out TB disease and to provide standardized education about TPT and potential side-effects. The caregiver is given 3 months of 3HR (orange solid bar), which is to last until the child's 3-month visit.

At the child's 3-month clinic visit, the child is evaluated and documented to have completed TPT.

The caregiver receives weekly treatment support (striped orange bar) from a CHW by SMS messaging throughout the 3 months.

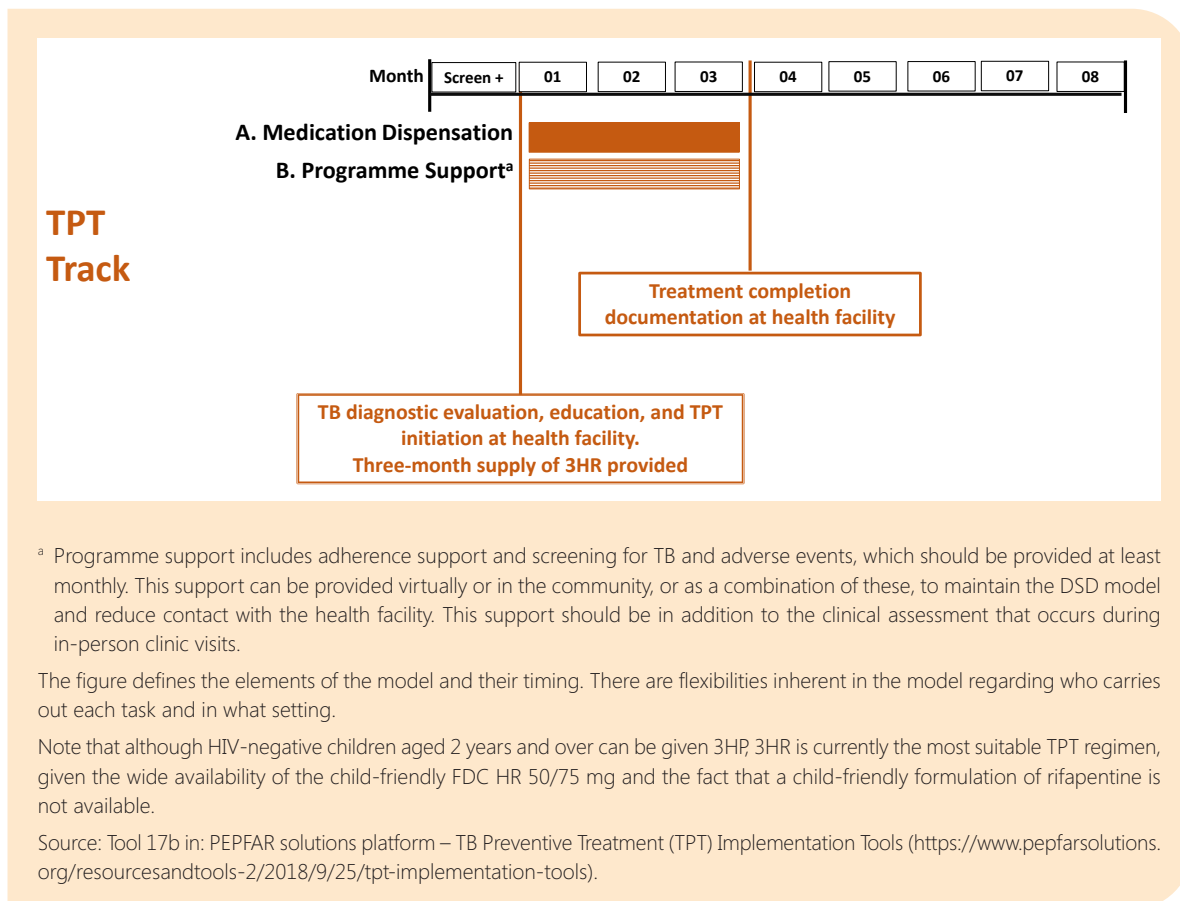

6.5. TB and health emergencies

Health emergencies, such as the COVID-19 pandemic, are associated with a disruption in health service delivery, either directly due to the focused attention given to the emergency or indirectly due to measures implemented to control the emergency.

The COVID-19 pandemic has reversed years of progress in providing essential TB services and reducing the disease burden of TB. There has been a large global drop in the number of people newly diagnosed with TB and reported. The number fell from 7.1 million in 2019 to 5.8 million (out of the approximately 10 million people estimated to have developed TB) in 2020, back to the level of 2012. Reduced access to TB diagnosis and treatment has resulted in an increase in the number of TB-related deaths. Estimates for 2020 are a total of 1.5 million TB-related deaths (up from 1.4 million in 2019), which means the number of deaths has gone back to the level of 2017. These impacts are forecast to be much worse in 2021 and 2022.

Children and young adolescents have been disproportionately affected by the COVID-19 pandemic, with notifications in children aged under 5 years decreasing by 28% and in children aged 5–14 years by 21% between 2019 and 2020, compared with 18% in people aged 15 years and over (7).

The negative impact of health emergencies is likely to be worse for vulnerable groups such as children and adolescents, who are usually dependent on adults to seek health care. Indirect impacts of health emergencies, such as reduced household income, increased poverty, food insecurity, malnutrition, missed health checks, missed vaccinations and missed schooling, may have a bearing on TB.

NTPs should ensure children and adolescents are not left behind as they design and implement innovative approaches to maintain TB service delivery during health emergencies and in the recovery stage (178).

In May 2021, WHO updated its information note on TB considerations in the context of COVID-19 to guide countries on approaches to maintain the continuity of TB services (179). These approaches should be people-centred while leveraging opportunities across both diseases. For example, both COVID-19 and TB have respiratory symptoms, which provides an opportunity for simultaneous testing to minimize chances of missing either disease and providing appropriate management (180). Invasive sample collection procedures such as sputum induction present an increased risk for TB and COVID-19 transmission if recommended infection control measures are not adhered to. Less invasive sample collection methods can be prioritized in such scenarios (see [Chapter 4](#) on diagnostic approaches).

NTPs should ensure supplies of child-friendly formulations are not interrupted and that children and adolescents with TB are provided with adequate refills to enhance treatment completion and minimize frequent trips to health facilities. This may be achieved via multimonth dispensing or community delivery of TB medicines.

Existing mechanisms should be enhanced to ensure sufficient stocks of TPT for the projected increased need for TPT resulting from people with undiagnosed TB and increased associated exposure because of COVID-19-related lockdowns. Efforts should be made to ensure neonatal and infant BCG vaccination continues uninterrupted.

Key messages

- Integrated patient-centred care and prevention is a key pillar of the End TB Strategy. The *Roadmap towards ending TB in children and adolescents* highlights the importance of integrated family- and community-centred strategies for TB care.
- New recommendations have been formulated on decentralized, integrated, family-centred models of TB care for TB case detection and provision of TPT.
- Case studies demonstrate that decentralized, integrated approaches to TB care can improve paediatric TB case detection and TPT uptake.
- Steps to consider when planning for the implementation of decentralized, integrated, patient- and family-centred services include policy analysis; stakeholder analysis; human resources for health capacity assessment; resource mapping; an assessment of access to TB medicines, including child-friendly formulations and supplies; management of health information; and health service delivery mapping.
- Enhanced engagement of the private sector in child and adolescent TB services is important to ensure all children and adolescents have access to the TB services that they need.
- DSD as a people-centred approach to health service delivery can be applied to children and adolescents with TB or at risk of TB.
- Emergencies that affect the delivery of or access to health services can have direct and indirect negative impacts on child and adolescent TB services. Innovative approaches to mitigate the impact of health emergencies should consider the special needs of children and adolescents with TB and exposed to TB.

7. Special situations

This chapter covers a range of special situations related to the management of TB in children and adolescents:

- **Section 7.1:** management of TB in children and adolescents living with HIV;
- **Section 7.2:** TB in pregnancy and management of newborns of mothers with TB disease;
- **Section 7.3:** palliative care for children and adolescents with TB;
- **Section 7.4:** care for adolescents with or at risk of TB;
- **Section 7.5:** TB in children with pneumonia;
- **Section 7.6:** management of children with TB and malnutrition.

7.1. Management of TB in children and adolescents living with HIV

This section outlines how to screen for, prevent and manage TB/HIV coinfection in children and adolescents living with HIV (CALHIV).

7.1.1. Introduction

Children and adolescents living with HIV have an increased risk of TB exposure, infection, progression to disease, and TB-related morbidity and mortality. This risk is influenced by the degree of immune suppression. Childhood HIV infection is particularly common in settings where antenatal HIV prevalence is high and interventions for prevention of vertical transmission are not implemented widely. In these settings, the prevalence of HIV is particularly high among infants and young children, an age group that is also at risk for TB.

In regions endemic for TB and HIV, TB is common in children living with HIV, and HIV infection is common in children with TB. HIV testing is recommended to be routinely offered to all children and adolescents with presumed or diagnosed TB (167). In 2020, of the 226 000 TB-related deaths in children, 21 000 (9%) were in children living with HIV (7).

Of 210 000 children notified in 16 high TB/HIV burden countries with TB in 2020, 143 000 (68%) had an HIV test result recorded. Of these, 7720 tested positive for HIV (5.4%). Of the 7720 children who were found to have TB/HIV coinfection, 6653 (86%) were receiving ART (7).

Box 7.1 WHO recommendation on HIV testing

Routine HIV testing should be offered to all patients, including children, with presumptive and diagnosed TB (*strong recommendation, low quality of evidence*).

7.1.2. TB screening in children and adolescents living with HIV

Because of their increased risk for TB, children aged under 10 years living with HIV should be screened for TB at every encounter with a HCW, with the following screen: cough, fever, poor weight gain or close contact with a person with TB (see [Chapter 2](#) on screening). For recommendations on screening tools for adolescents aged 10–19 years living with HIV, see [Box 2.7](#) in [Chapter 2 \(13\)](#).

Positive or abnormal screening tests identify children and adolescents living with HIV who have a higher probability of TB disease and should be referred for diagnostic evaluation (see [Section 7.1.4](#) and [Chapter 4](#)). People with normal or negative screening tests or algorithm results should be referred for evaluation for TPT (see [Section 7.1.3](#) and [Chapter 3](#)).

W4SS (current cough, fever, weight loss and night sweats) is a simple non-invasive screening approach that does not require infrastructure (technology, electricity, internet) and is feasible to implement in any setting. The results of a symptom screening are subjective, however, and depend on the patient's level of understanding and willingness to share their physical experience of symptoms, and on the provider's interpretation of the patient's self-reported symptoms. The quality and consistency of W4SS, therefore, are likely to vary among clinical settings.

The evidence review conducted for the 2021 TB screening guidelines showed that W4SS has relatively high sensitivity (83%) but low specificity (38%) in adults and adolescents living with HIV. The sensitivity of W4SS among outpatients on ART is relatively low (53%), indicating that W4SS alone would not be sufficient to detect TB among people receiving regular ART care.

Despite these limitations, W4SS is an essential part of the clinical examination of most subpopulations and is the most accessible screening tool at all levels of the health system. It can be repeated as often as necessary, with more intense screening strategies used less frequently, such as at annual check-ups.

Familiarity with W4SS is widespread in many HIV services as a result of capacity-building and supervision. It also has an important role in ruling out TB disease due to its high negative predictive value in most settings, which is important to identify people living with HIV who would benefit from TPT in the absence of TB disease (13).

CRP is an indicator of systemic inflammation that can be measured with a blood test. A point-of-care fingerprick test is available, making it simple, affordable and feasible in primary care. The turnaround time from testing to receiving the result with many CRP test kits is 3–5 minutes, allowing a quick clinical decision to refer a patient for diagnostic evaluation for TB disease or initiation of TPT. An additional potential benefit of CRP is that it can alert clinicians to the presence of other diseases, such as bacterial pneumonia, bronchitis, and other infectious and non-infectious conditions (e.g. lymphoma). Data reviewed for the 2021 screening guideline revision support sequential combination of a positive W4SS followed by CRP with a cut-off of >5 mg/L, particularly for people not on ART. CRP can also play an important role in ruling out TB disease before initiation of TPT (13).

CXR is useful for screening people living with HIV for TB. It is currently recommended by WHO for use in parallel with W4SS for ruling out TB disease before initiating TPT. Similarly, CXR can be used in parallel with W4SS to screen for TB disease, with a positive or abnormal result on either CXR or W4SS indicating the need for further diagnostic evaluation. "Any abnormality" or "abnormality suggestive of TB" on CXR can be used, depending on the context, availability of radiological expertise and resources, and a preference for higher sensitivity or higher specificity (13).

Further details on these screening tools, their accuracy and considerations for their use in adolescents living with HIV are described in [Chapter 5](#) of the *WHO operational handbook on tuberculosis. Module 2: screening – systematic screening for tuberculosis disease (13)*.

7.1.3. Prevention of TB in children and adolescents living with HIV

Global efforts to control the co-epidemics of TB and HIV will benefit children and adolescents. They include the expansion of prevention of mother-to-child transmission programmes, which will reduce the number of new HIV infections in young children. In addition, all children living with HIV should be screened for TB, and all children and their families with TB should be offered HIV testing and counselling in settings of high HIV prevalence.

All children and adolescents living with HIV who are household contacts of people with infectious TB should be evaluated for TB disease and either treated for TB or given TPT if screening finds they are unlikely to have TB disease (see [Chapter 3](#)). Innovative approaches are needed to ensure coinfecting children are identified and, where possible, disease is prevented. This requires integration of services and collaborative TB and HIV activities by national TB and HIV programmes and other stakeholders (167).

Infants and children living with HIV should not receive BCG vaccination because they are at increased risk of developing disseminated BCG disease. Infants and children living with HIV who are on ART, are clinically well and are immunologically stable should, however, be vaccinated (see [Chapter 3](#)) (31).

The approach to screening and management of children and adolescents living with HIV who are contacts of a person with TB is outlined in [Chapter 2](#). A child living with HIV exposed to a person with infectious TB is at particularly high risk of developing TB disease (15, 22, 167). WHO recommendations are that household contacts of people with infectious TB should be screened for symptoms of TB. If TB is excluded, TPT should be offered to children aged under 5 years, irrespective of their HIV status and availability of TB infection testing. Children aged 5 years and over, adolescents and adults who are household contacts of people with bacteriologically confirmed PTB who are found not to have TB disease by an appropriate clinical evaluation or according to national guidelines may be given TPT, irrespective of their HIV status.

Adolescents and children aged 12 months and over living with HIV who are unlikely to have TB disease should receive TPT as part of a comprehensive package of HIV care, regardless of history of TB contact. TPT should also be given to adolescents and children aged 12 months and over on ART; to pregnant adolescents; and to adolescents and children aged 12 months and over who have previously been treated for TB, irrespective of the degree of immunosuppression or availability of TB infection testing. For infants aged under 12 months living with HIV, the recommendation is that they should receive TPT if they are in contact with a person with TB and if they are unlikely to have TB disease on an appropriate clinical evaluation or according to national guidelines (see [Chapter 3](#)) (15, 28).

7.1.4. Diagnosis of TB in children and adolescents living with HIV

The approach to diagnosing TB in children and adolescents living with HIV is essentially the same as diagnosing TB in HIV-negative children (see [Chapter 4](#)). Diagnosis of TB in children and adolescents living with HIV can be more challenging than in HIV-negative children, however (6):

- Clinical features consistent with PTB are common in children and adolescents living with HIV but may be caused by other diseases and therefore lack specificity for a diagnosis of TB.
- Most children living with HIV have been infected via mother-to-child transmission. The peak age prevalence for HIV is under 5 years. This is also the age group in which it is most difficult to confirm the cause of acute or chronic lung disease, including TB.
- TST is less sensitive in children and adolescents living with HIV than in HIV-negative children and adolescents. Induration of >5 mm is considered positive if the child is living with HIV (see [Annex 2](#)).

- Children and adolescents living with HIV have a very high incidence of acute and chronic lung diseases other than TB.
- Children and adolescents living with HIV may have lung disease of more than one single cause (coinfection), which can mask response to therapy.
- There is an overlap of radiographic findings in TB and other HIV-related lung diseases.

The integrated treatment decision algorithms for the diagnosis of PTB in [Chapter 4](#) may be used in children living with HIV aged under 10 years. In these algorithms, children living with HIV are regarded as having a relatively high risk for TB when they present with symptoms of PTB, and the steps applicable to the high-risk group should be used. As with all children with presumptive PTB, every attempt should be made to confirm the diagnosis by conducting mWRDs on suitable specimens, including stool, nasopharyngeal aspirate, (induced) sputum and gastric aspirate (depending on equipment and expertise available). This is especially important for children living with HIV who are contacts of people with confirmed DR-TB.

LF-LAM is an important additional diagnostic test in children and adolescents living with HIV. Urine LF-LAM is an immunocapture assay based on the detection of the mycobacterial lipoarabinomannan antigen in urine. This is a potential point-of-care test for certain populations being evaluated for TB. Although the assay lacks sensitivity, it can be used as a fast bedside rule-in test for people living with HIV, including children and adolescents, especially in urgent cases where a rapid TB diagnosis is critical for the person's survival. The Alere Determine TB LAM Ag is the only commercially available urine LF-LAM test endorsed by WHO (76).

All children and adolescents living with HIV with signs and symptoms of PTB should have at least one specimen (stool, NPA, sputum or gastric aspirate in children; sputum in adolescents) submitted for an mWRD assay if possible. Results of LF-LAM, with a test time of less than 15 minutes, are likely to be available before mWRD results. Treatment decisions should be based on the LF-LAM result while awaiting the results of other diagnostic tests. LF-LAM should be used as an add-on to clinical judgement in combination with other tests (see [Box 4.4](#) in Chapter 4). LF-LAM should not be used as a replacement or triage test. A positive LF-LAM is regarded as bacteriological confirmation of TB (76).

For children living with HIV with signs and symptoms of EPTB, the guidance in [Chapter 4](#) applies as well.

7.1.5. Treatment of TB in children and adolescents living with HIV

Children living in settings where the prevalence of HIV is high or who are living with HIV should be treated for TB with a four-medicine regimen (isoniazid, rifampicin, pyrazinamide and ethambutol) for 2 months followed by a two-medicine regimen (isoniazid and rifampicin) for 4 months or 2 months (for non-severe TB) at standard dosages given daily.

Eligibility for the 4-month treatment regimen depends on the severity of disease and can be determined using CXR features or clinical criteria described in [Chapter 5](#).

The child should be assessed 2 weeks after the start of TB treatment and then reviewed monthly with clinical monitoring, which should include symptom assessment, weight measurement, assessment of adherence to treatment, and enquiry about any adverse events. Dosages of TB medicines should be adjusted to account for any weight gain.

Most children living with HIV with drug-susceptible TB who are adherent to treatment have a good response to the 6-month regimen. Possible reasons for treatment failure are non-adherence to treatment, DR-TB or alternative diagnoses (e.g. incorrect diagnosis of TB).

All children living with HIV who have successfully completed treatment for TB disease may receive TPT.

Response to TB treatment and treatment outcomes are poorer for children living with HIV than for HIV-negative children. Before the wide availability of ART, many deaths in children with TB/HIV coinfection occurred in the first 2 months following the start of TB treatment. Medical risk factors for poor treatment response and mortality include severe malnutrition, coinfections, severe immunosuppression and high viral load.

Additional therapy recommended for children living with HIV who have TB, which may help improve TB treatment outcomes include CPT (see [Section 7.1.6](#)), early start of ART (see [Section 7.1.7](#)), and pyridoxine supplementation and nutritional support.

7.1.6. Co-trimoxazole preventive therapy

Co-trimoxazole is a broad-spectrum antimicrobial medicine that prevents a range of secondary bacterial and parasitic infections in eligible people living with HIV. Daily prophylaxis with CPT prolongs survival and reduces the incidence of comorbidities in children living with HIV. It also reduces the risk of coinfections such as pneumocystis pneumonia in infants exposed to HIV. CPT is recommended for all HIV-exposed infants and children living with HIV, including those with TB (79), and should be implemented as an integral component of a package of HIV-related services (see [Box 7.2](#)).

Indications for initiating, discontinuing and monitoring CPT are included in the 2021 *WHO consolidated guidelines on HIV prevention, testing, treatment, service delivery and monitoring* (78).

Box 7.2 WHO recommendations on co-trimoxazole prophylaxis

Co-trimoxazole prophylaxis is recommended for infants, children and adolescents living with HIV, irrespective of clinical and immune conditions. Priority should be given to all children younger than 5 years old regardless of CD4 cell count or clinical stage, and children with severe or advanced HIV clinical disease (WHO clinical stage 3 or 4, including pulmonary and extrapulmonary TB) and/or those with a CD4 count ≤ 350 cells/mm³ (*strong recommendation, high certainty evidence*).

In settings where malaria and/or severe bacterial infections are highly prevalent, co-trimoxazole prophylaxis should be continued until adulthood, irrespective of whether antiretroviral therapy is provided (*conditional recommendation, moderate certainty evidence*).

In settings with low prevalence for both malaria and bacterial infections, co-trimoxazole prophylaxis may be discontinued for children 5 years of age and older who are clinically stable and/or virally suppressed on antiretroviral therapy for at least 6 months and with a CD4 count >350 cells/mm³ (*strong recommendation, very low certainty evidence*).

Co-trimoxazole prophylaxis is recommended for HIV-exposed infants from 4 to 6 weeks of age and should be continued until HIV infection has been excluded by an age-appropriate HIV test to establish final diagnosis after complete cessation of breastfeeding (*strong recommendation, very-low-certainty evidence*).

Routine co-trimoxazole prophylaxis should be given to all people living with HIV with TB disease regardless of CD4 cell count (*strong recommendation, high-certainty evidence*).

Source: Consolidated guidelines on HIV prevention, testing, treatment, service delivery and monitoring: recommendations for a public health approach. Geneva: World Health Organization; 2021 (78).

7.1.7. Antiretroviral therapy

ART in children and adolescents living with HIV aims to improve the length and quality of life, reduce HIV-related morbidity and mortality by reducing the incidence of opportunistic infections (including TB), reduce the viral load, restore and preserve immune function, and restore and preserve normal growth and development. ART improves TB treatment outcomes for children and adolescents living with HIV (6).

WHO recommends that ART should be initiated in all adolescents and children living with HIV, regardless of WHO clinical stage and CD4 cell count. Rapid initiation of ART (within 7 days from the day of HIV diagnosis) should be offered to all people living with HIV following a confirmed HIV diagnosis and clinical assessment. Children and adolescents with advanced HIV disease should be given priority for assessment and initiation. Initiation of ART should be offered on the same day to people living with HIV who are ready to start (78).

Initiation of ART should follow the overarching principles of people-centred care. People-centred care is focused and organized around the health needs, preferences and expectations of people and communities; upholds individual dignity and respect, especially for vulnerable populations; and engages and supports people and families to play an active role in their own care by informed decision-making. People living with HIV should be encouraged but not coerced to start ART immediately and should be supported in making an informed choice regarding when to start ART and what regimen to use (78).

7.1.7.1. Timing of antiretroviral therapy

WHO recommendations on the timing of ART for children and adolescents with TB were updated in 2021 (78). ART should be started as soon as possible within two weeks of initiating TB treatment, regardless of CD4 count, among adolescents and children living with HIV (except when signs and symptoms of meningitis are present). In children and adolescents living with HIV with TBM, ART should be delayed at least 4 weeks after treatment for TBM is initiated and initiated 4–8 weeks after starting TB treatment (see Box 7.3). The recommendation on the use of adjuvant corticosteroid therapy with dexamethasone or prednisolone (tapered over 6–8 weeks) also applies to children and adolescents living with HIV with TBM (107).

Box 7.3 WHO recommendations on timing of antiretroviral therapy in children and adolescents with TB

Antiretroviral therapy should be started as soon as possible within 2 weeks of initiating TB treatment, regardless of CD4 count, among adolescents and children living with HIV (except when signs and symptoms of meningitis are present) (*adolescents: strong recommendation, low- to moderate-certainty evidence; children and infants: strong recommendation, very low certainty evidence*).

Clinical statements:

- ➔ Antiretroviral therapy should be delayed at least 4 weeks (and initiated within 8 weeks) after treatment for TB meningitis is initiated.
- ➔ Corticosteroids should be considered adjuvant treatment for TB meningitis.

Source: Consolidated guidelines on HIV prevention, testing, treatment, service delivery and monitoring: recommendations for a public health approach. Geneva: World Health Organization; 2021 (78).

7.1.7.2. Choice of antiretroviral therapy regimen

The 2021 *WHO consolidated guidelines on HIV prevention, testing, treatment, service delivery and monitoring* provide recommendations based on rapidly evolving evidence of safety and efficacy and programmatic experience using DTG and low-dose EFV in pregnant women and people (including children and adolescents) with TB/HIV coinfection (78).

DTG is approved for use among children aged over 4 weeks and weighing more than 3 kg. A dispersible 10 mg formulation of DTG is available on the market. Among children for whom approved dosing of DTG is not available, RAL is considered an effective option and is approved for use from birth (with dose adjustments during TB treatment). RAL should be substituted with DTG as soon as it is available from 4 weeks of life.

DTG in combination with a NRTI backbone is recommended as the preferred first-line regimen for adolescents living with HIV and for infants and children with approved DTG dosing who are starting ART. EFV at low dose (400 mg) in combination with a NRTI backbone is recommended as the alternative first-line regimen for adolescents living with HIV starting ART (except in settings with pre-treatment HIV drug resistance to EFV or NVP over 10%). EFV 400 mg can be co-administered with rifampicin-containing TB treatment, with co-administration well tolerated and plasma concentrations maintained above the levels considered to be effective (181).

If DTG is not available, the preferred first-line ART regimen is a LPV/r-based regimen. RAL should be used only under special circumstances, such as in neonates. Beyond the neonatal period, infants and children should be transitioned to DTG as soon as possible.

Table 7.1 summarizes the preferred and alternative first-line ART regimens for neonates, children and adolescents on TB treatment (78).

Table 7.1. Preferred and alternative first-line antiretroviral therapy regimens for neonates, children and adolescents on TB treatment

Age	Preferred first-line regimen, including initiation while on TB treatment	Alternative first-line regimen	Special circumstances ^a
Neonates	AZT + 3TC + RAL ^b	AZT + 3TC + NVP	AZT + 3TC + LPV/r ^c
Children	ABC + 3TC + DTG ^d	ABC + 3TC + LPV/r TAF + 3TC (or FTC) + DTG ^e	ABC + 3TC + EFV (or NVP) ABC + 3TC + RAL ^f AZT + 3TC + EFV ^g (or NVP) AZT + 3TC + LPV/r (or RAL)
Adolescents	TDF + 3TC (or FTC) + DTG ^h	TDF + 3TC + EFV 400 mg ⁱ	TDF + 3TC (or FTC) + EFV 600 mg ⁱ AZT + 3TC + EFV 600 mg ⁱ TDF + 3TC (or FTC) + PI/r ⁱ TDF + 3TC (or FTC) + RAL TAF ^j + 3TC (or FTC) + DTG ABC + 3TC + DTG ^h

3TC: lamivudine; ABC: abacavir; AZT: zidovudine; DTG: dolutegravir; EFV: efavirenz; FTC: emtricitabine; LPV/r: lopinavir/ritonavir; NVP: nevirapine, PI/r: protease inhibitor boosted with ritonavir; RAL: raltegravir; TAF: tenofovir alafenamide; TDF: tenofovir disoproxil fumarate.

■ No dose adjustment needed with TB treatment.

■ Dose adjustment needed with TB treatment.

■ Change of regimen needed with TB treatment.

For details on required adjustments in dose or regimen, see [Table 7.2](#).

^a Special circumstances include where it is not possible to give the preferred or alternative regimens, including toxicity, intolerance, inability to take the preferred or alternative medicine in the available formulation, and unavailability or stockouts.

^b Neonates starting ART with a RAL-based regimen should transition to an LPV/r solid formulation as soon as possible.

^c LPV/r syrup or granules can be used if starting after age 2 weeks.

^d For age and weight groups with approved DTG dosing.

^e For age and weight groups with approved TAF dosing.

^f RAL should be used as an alternative regimen only if LPV/r solid formulations are not available.

^g Efavirenz should not be used in children aged under 3 years.

^h Effective contraception should be offered to adolescent girls of childbearing age or potential. DTG can be prescribed for adolescent girls of childbearing age or potential who wish to become pregnant or who are not otherwise using or accessing consistent and effective contraception if they have been fully informed of the potential increase in the risk of neural tube defects (at conception and until the end of the first trimester). If women identify pregnancy after the first trimester, DTG should be initiated or continued for the duration of the pregnancy.

ⁱ EFV-based ART should not be used in settings with national estimates of pre-treatment resistance to EFV of 10% or higher. DTG-based ART is preferred. If DTG is unavailable, a boosted PI-based regimen should be used. The choice of PI/r depends on programmatic characteristics.

^j TAF may be considered for people with established osteoporosis or impaired kidney function. TAF has drug–drug interactions with rifamycin; as dose adjustments have not been established, concurrent use should be avoided.

DTG in combination with an optimized NRTI backbone may be used as a preferred second-line regimen for adolescents and children living with HIV with approved DTG dosing for whom non-DTG-based regimens are failing. Boosted protease inhibitors (PIs) in combination with an optimized NRTI backbone are recommended as a preferred second-line regimen for people living with HIV for whom DTG-based regimens are failing.

7.1.7.3. Adjustments to antiretroviral therapy regimens with TB treatment

In people with TB/HIV coinfection, the dose of DTG needs to be doubled by giving it twice instead of once a day because of drug–drug interactions with rifampicin. This extra dose of DTG is well tolerated, with equivalent efficacy in viral suppression and recovery of CD4 cell count compared with EFV (182, 183).

Table 7.2 summarizes changes needed to ART regimens for neonates, children and adolescents who are on ART when TB treatment is started, or who start ART while on TB treatment.

Table 7.2. Changes needed to antiretroviral therapy regimens for neonates, children and adolescents on drug-susceptible TB treatment

Age	ART regimen	Changes needed for children on ART who are starting TB treatment, or for children starting ART while on TB treatment
Neonates (first 28 days of life)	RAL-based ^a	Dose adjustment is needed: double the twice-daily dose while on TB treatment From age 4 weeks and weight >3 kg, transition to DTG-based regimen If neonate is on AZT, switch to ABC after neonatal period
	NVP-based	Change of regimen is needed: substitute NVP as soon as possible with DTG or LPV/r (with appropriate dose adjustment; see under DTG- and LPV/r-based regimens for children)
Children	DTG-based ^a	Dose adjustment is needed: dose DTG twice daily instead of once daily while on TB treatment
	LPV/r-based	Transition to DTG-based regimen (with appropriate dose adjustment) is preferable If not possible, LPV/r dose adjustment is needed: ritonavir (RTV) dose needs to be “super-boosted” to achieve same dose as LPV in mg, in a ratio equal to or approaching 1 : 1
	RAL-based	Transition to DTG-based regimen (with appropriate dose adjustment) is preferable; if not possible, RAL dose adjustment is needed: double the twice-daily dose while on TB treatment
	TAF-containing	Change of regimen is needed: substitute TAF with ABC or TDF
	ATV/r-based	Change of regimen is needed: replace ATV/r with DTG if DTG-naïve or with LPV/r if DTG-experienced (with appropriate dose adjustment)
	DRV/r-based	Change of regimen is needed: replace DRV/r with DTG if DTG-naïve or with LPV/r if DTG-experienced (with appropriate dose adjustment)

Age	ART regimen	Changes needed for children on ART who are starting TB treatment, or for children starting ART while on TB treatment
Adolescents	DTG-based	Dose adjustment is needed: adjust dose of DTG (50 mg twice daily instead of 50 mg once daily)
	LPV/r-based	Transition to DTG-based regimen (with appropriate dose adjustment) is preferable If not possible, LPV/r dose adjustment is needed: “double-dose” LPV 800 mg/RTV 200 mg twice daily or “super-boosted” with LPV 400 mg/RTV 100 mg twice daily plus additional doses of RTV 300 mg twice daily Note: rifapentine (e.g. the 4-month treatment regimen for drug-susceptible TB consisting of HPZM) should not be used
	RAL-based	Transition to DTG-based regimen (with appropriate dose adjustment) is preferable If not possible, RAL dose adjustment is needed: adjusted dose of RAL (800 mg twice daily instead of 400 mg twice daily)
	Other regimens	See under children

^a Preferred ART regimen for initiation in neonates and children on TB treatment.

3TC: lamivudine; ABC: abacavir; ATV/r: atazanavir/ritonavir; AZT: zidovudine; DRV/r: darunavir/ritonavir; DTG: dolutegravir; EFV: efavirenz; FTC: emtricitabine; LPV/r: lopinavir/ritonavir; NVP: nevirapine; RAL: raltegravir; RTV: ritonavir; TAF: tenofovir alafenamide; TDF: tenofovir disoproxil fumarate.

For details on dosing of ART medicines with TB treatment in neonates, children and adolescents, see the interactive dosing table at <https://paedsarvdosing.org>. A useful tool for checking drug–drug interactions is at <https://www.hiv-druginteractions.org/>.

7.1.7.4. TPT in children and adolescents living with HIV on antiretroviral therapy

A key challenge with rifamycin-based TPT regimens in people living with HIV is drug–drug interactions. Rifampicin and rifapentine can be co-administered with EFV or DTG without dose adjustment. In people on RAL and rifamycins, however, a higher dosage of RAL (800 mg twice a day instead of 400 mg twice a day) should be used. This dose adjustment applies only to adolescents, as pharmacokinetic studies on the use of 3HP, 1HP and 3HR in children on various new ART regimens are ongoing. Rifampicin or rifapentine TPT regimens should not be co-administered with protease inhibitors or nevirapine. Further details on drug–drug interactions between TPT and ART medicines can be found in Chapter 6 of the *WHO operational handbook on tuberculosis. Module 1: prevention – tuberculosis preventive treatment (15)*.

Table 7.3 summarizes the TPT options for people on ART.

Table 7.3. TB preventive treatment options for children and adolescents on antiretroviral therapy

6H	3HP	3HR	4R	1HP	H+B6+CTX (Q-TIB)
No restrictions	Contraindicated: • all PIs • NVP and NNRTIs • TAF	Contraindicated: • all PIs • NVP and most NNRTIs	Contraindicated: • all PIs • NVP and most NNRTIs • TAF	Contraindicated: • all PIs • NVP and most NNRTIs • TAF	No restrictions
		Use with caution: • TAF			
		Adjust dose: • DTG • RAL	Adjust dose: • DTG • RAL		
	Use: • TDF • EFV (600 mg) • DTG • RAL ^a	Use: • TDF • EFV (600 mg) ^b	Use: • TDF • EFV (600 mg) ^b	Use: • TDF • EFV (600 mg) ^b • DTG ^c • RAL ^c	

^a Drug interaction has been studied in adults but not children; applies only to adolescents and adults taking DTG or RAL only.

^b EFV 600 mg applies to adolescents and adults; EFV is not recommended in children aged under 3 years.

^c For adolescents on 1HP who are taking DTG or RAL, dosing of DTG and RAL needs to be adjusted as per [Table 7.2](#).

Abbreviations: B6: pyridoxine; CTX: co-trimoxazole; DTG: dolutegravir; EFV: efavirenz; H: isoniazid; NNRTIs: non-nucleoside reverse-transcriptase inhibitors; NVP: nevirapine; PIs: protease inhibitors; RAL: raltegravir; TAF: tenofovir alafenamide; TDF: tenofovir disoproxil fumarate.

7.1.8. Immune reconstitution inflammatory syndrome

Also known as a paradoxical reaction, IRIS is a temporary clinical deterioration that may occur within 3 months (most commonly within the first month) of starting ART. As the immune system starts to recover after ART is initiated, the CD4 count increases and the viral load is suppressed. This reconstitution of cell-mediated immunity in response to mycobacterial antigens can trigger an inflammatory reaction to TB antigens at the sites of TB disease. This causes either deterioration of a treated infection or new presentation of a previously subclinical infection (6, 184, 185).

Risk factors for IRIS include low baseline CD4 count, extensive or disseminated TB, early initiation of ART, and rapid immunological and virological responses to ART. TB-IRIS and BCG-IRIS are a cause of significant morbidity, but they are not associated with an increased mortality risk.

Although IRIS following BCG immunization has frequently been reported in children (186), paradoxical and unmasking TB-IRIS is not as well documented in children as in adults. This is largely due to the difficulties in diagnosing TB in children living with HIV. TB-IRIS is, therefore, often a diagnosis of exclusion in children.

There are two main presentations of TB-IRIS:

- exacerbation of known TB disease in a child or adolescent living with HIV on TB treatment who is starting ART (paradoxical TB-IRIS);
- development of TB disease in a child or adolescent living with HIV starting ART (unmasking TB-IRIS).

When paradoxical TB-IRIS is suspected in a child or adolescent, it is important to assess adherence to ART and TB treatment, enquire about exposure to DR-TB, obtain appropriate specimens for Xpert MTB/RIF or Ultra, and exclude alternative diagnoses (e.g. acute bacterial infections, drug reactions, other opportunistic infections, malignancies).

Broad-spectrum antibiotics should be prescribed to a child or adolescent with clinical deterioration after starting ART in whom a bacterial infection is considered in the differential diagnosis. In most cases, it is safe to continue TB treatment and ART. Temporarily stopping ART should be considered if TB-IRIS is life-threatening or likely to cause permanent disability. Non-steroidal anti-inflammatory drugs may be considered for mild to moderate TB-IRIS. Corticosteroids may be considered for severe TB-IRIS (784) but should not be used if DR-TB is a likely diagnosis. If there is any doubt about the diagnosis or management, the child should be referred to the next level of care.

7.2. TB in pregnancy and management of newborns of mothers with TB disease

TB contributes to 6–15% of all maternal mortality and leads to adverse pregnancy outcomes (787). A national registry study found incidence rate ratios for TB in pregnant and postpartum women of 1.4 and 1.9, respectively, compared with non-pregnant women (788). TB in pregnancy is associated with adverse maternal outcomes and complications during birth, such as pre-eclampsia, eclampsia, vaginal bleeding, hospitalization and miscarriage. Perinatal outcomes include a two-fold increased risk of premature birth, low birthweight and intrauterine growth retardation, and a six-fold increased risk of perinatal death (789–791). Maternal TB more than doubles the risk of vertical transmission of HIV (792), and increases the risk of mortality not only in the newborn but also in other young children living in the household (793). The increase in TB incidence in the postpartum period is likely due to delays in early detection during pregnancy as a result of related physiological and immunological changes (794).

In the absence of systematic collection of data on TB in pregnancy, modelling studies have estimated that more than 215 000 TB cases occur annually among pregnant and postpartum women, with the vast majority of cases occurring in Africa and South-East Asia (795). This may be an underestimate because the study assumed equivalent sensitivity of screening algorithms and diagnostic tests in pregnant and postpartum women as in non-pregnant adults.

The symptoms of TB disease in pregnancy are similar to those in non-pregnant women. Pregnancy may mask true weight loss, however, and failure to gain weight is an important symptom to consider. PTB is the most common form of TB disease in pregnancy. Disseminated TB occurs in 5–10% of pregnant women with TB disease and is a particular risk factor for congenital TB in newborns. All pregnant women in regions endemic for TB and HIV should be screened for symptoms of TB. It is equally important that pregnant women with presumptive TB are tested for HIV (6).

As maternal TB increases the risk of vertical transmission of HIV, TB treatment must be started promptly to prevent transmission. The treatment of TB in pregnant women is the same as for non-pregnant women. All pregnant women with TB/HIV coinfection are eligible for ART and should be treated according to the most recent WHO guidelines (78).

7.2.1. Screening for TB in pregnant women living with HIV

Pregnant women living with HIV are a key population for screening for TB disease, given the suppressed immune status of the mother and the importance of protecting the health of the fetus. TB screening for this population should be integrated with prevention of vertical transmission and antenatal care. Table 7.4 provides an overview of the diagnostic accuracy of different screening tools (13).

Table 7.4. Diagnostic accuracy of WHO-recommended screening tools in pregnant women living with HIV

Diagnostic accuracy compared with culture reference standard	Sensitivity	Specificity
W4SS	61%	58%
CRP (cut-off value >5 mg/L)	70%	41%
W4SS combined with CXR (any abnormality)	75%	56%
mWRDs	55%	99%

7.2.2. Congenital and neonatal TB

Congenital TB is TB disease acquired in utero through haematogenous spread via the umbilical cord or at the time of delivery through aspiration or ingestion of infected amniotic fluid or cervicovaginal secretions. Congenital TB usually presents in the first 3 weeks of life and has a high mortality rate. Neonatal TB is TB acquired after birth through exposure to a person with infectious TB (usually the mother but sometimes another close contact). It is often difficult to distinguish between congenital and neonatal TB. Management is the same. Neonates exposed to TB may be asymptomatic or symptomatic (6).

Symptoms of neonatal TB are usually nonspecific. They include lethargy, fever, poor feeding, low birth weight and poor weight gain. Clinical signs are also nonspecific; they include respiratory distress, non-resolving pneumonia, hepatosplenomegaly, lymphadenopathy, abdominal distension with ascites, and a clinical picture of “neonatal sepsis” with disseminated TB. The diagnosis of TB should be included in the differential diagnosis of chronic neonatal infection with a poor response to antimicrobial therapy. The most important pointer to the diagnosis of neonatal TB is a maternal history of TB disease or HIV infection. Critical points in the maternal history include non-resolving pneumonia, past treatment for TB, contact with an index case of TB, and recent initiation of treatment for TB (6).

7.2.2.1. Management of congenital and neonatal TB

Treatment of congenital TB and neonatal TB is the same. Both should be managed by a clinician experienced in the management of paediatric TB. A complete investigation of mother and neonate should be undertaken. CXR should be done and appropriate specimens collected for Xpert MTB/RIF or Ultra to confirm the diagnosis of TB in the neonate (see Chapter 4). Treatment should be started based on the likelihood of TB, even before bacteriological confirmation is received, as TB can progress rapidly in neonates. Infants aged under 3 months or weighing less than 3 kg (including premature birth before 37 weeks) were not eligible for inclusion in the SHINE trial (86, 196). If PTB or tuberculous peripheral lymphadenitis is suspected or confirmed in these infants, they should be treated promptly with a 6-month treatment regimen (2HRZ(E)/4HR), as per the existing recommendation from the 2014 *Guidance for national tuberculosis programmes on the management of tuberculosis in children* (6). Treatment may require dose adjustment to reconcile the effect of age and possible toxicity in young

infants. The decision to adjust doses should be taken by a clinician experienced in managing paediatric TB. WHO recommendations on treatment for DR-TB apply to neonates as well (see [Chapter 5](#)).

Dosages must take account of body weight and weight gain, which can be rapid in young infants. Pharmacokinetic data to inform appropriate dosages of TB medicines in neonates, especially preterm neonates, are very limited.

A favourable response to treatment is indicated by increased appetite, weight gain and radiographic resolution. Breastfeeding is recommended, irrespective of the mother's TB status. The risk of TB transmission through breast milk is negligible and, although the most commonly used TB medicines are excreted into breast milk in small amounts, there is no evidence that this induces drug resistance. Separation from the mother is not advised, especially in resource-limited settings, where establishing breastfeeding can be critical for the child's survival. If TB is presumed or confirmed in the mother of an acutely ill neonate, the mother and her baby should be separated from the neonatal unit as soon as possible to prevent transmission to other neonates (6).

7.2.3. Management of asymptomatic neonates of mothers with TB

TB disease should be excluded in neonates born to women with presumptive or confirmed TB. The level of infectiousness and drug susceptibility in the mother should be determined. It is not necessary to separate the neonate from the mother. Breastfeeding should be continued and the mother advised to wear a surgical mask when close to the baby (791). While screening for TB disease or TB infection is ongoing, BCG should be postponed in neonates exposed to TB; the main reason for this is that BCG will interfere with the interpretation of TST, reducing the effectiveness of the test for diagnosing infection.

Neonates diagnosed with HIV infection, as confirmed by early virological testing, should not receive BCG at birth. Vaccination should be delayed until ART has been started and the infant is confirmed to be immunologically stable (CD4 >25% for children aged under 5 years; CD4 count \geq 200 for children aged over 5 years) (see [Chapter 3](#)).

Neonates born to women with bacteriologically confirmed PTB and who are well (without any signs or symptoms of TB) should receive preventive treatment once TB disease has been excluded. BCG vaccination should be delayed until after completion of TPT. 3HR using the child-friendly HR 50/75 mg FDC is a good option for infants who have not been exposed to HIV, but consultation with a neonatal specialist is advised. If the infant has been exposed to HIV (e.g. mother is living with HIV) and is on NVP, IPT should be started (TPT with rifamycins cannot be given along with NVP prophylaxis since these decrease NVP levels, which may result in increased vertical transmission of HIV). Infants on TPT should receive pyridoxine 5–10 mg/day. They should be regularly followed up and monitored for the development of symptoms and signs suggestive of TB. If the infant remains asymptomatic after completion of TPT, TB infection testing (TST or IGRA) should be performed if available. If TST or IGRA is negative or not available, and the infant is HIV-negative, BCG vaccination should be provided using a normal infant dose, 2 weeks after completion of the full course of TPT (15, 31).

If the mother is non-infectious, the infant should be screened for TB. If there is no evidence of TB disease, the infant should be followed up regularly to ensure TB disease does not develop, and TPT should be considered.

Neonates born to women with MDR/RR-TB should be referred to a local expert in the management of paediatric MDR/RR-TB. Infection control measures such as wearing masks are required to reduce the likelihood of transmission to the neonate (6).

Box 7.4 Management of babies born to women with TB disease (15)

- Assess the newborn. If the newborn is not well, refer to a specialist or paediatrician for further evaluation and to start a 6-month course of TB treatment if TB is confirmed or highly likely. It is important to ensure the mother receives effective TB treatment so she is no longer infectious. Ensure infection control measures are in place in the nursery, especially if the baby is in an inpatient facility for care when preterm or small at birth.
- If the newborn is well and without any signs or symptoms of TB, provide TPT (preferably 3HR) and delay BCG vaccination until TPT is complete. Administer pyridoxine 5–10 mg/day.
- If the infant is exposed to HIV (e.g. mother living with HIV) and is on nevirapine, IPT should be started. TPT with rifamycins (e.g. 3HR or 3HP) should not be given with nevirapine prophylaxis.
- At the end of TPT, do TST or IGRA. If the test for TB infection is negative or not available, give BCG (unless the baby is living with HIV). If the test is positive, BCG is not required.
- If the mother is taking TB medicines, she can safely breastfeed. The mother and baby should stay together, and the baby may be breastfed while on TPT.
- An infant breastfeeding from a mother on TB treatment or TPT should receive pyridoxine for the duration of the mother's treatment.

7.3. Palliative care for children and adolescents with TB

7.3.1. Introduction

In 2014, World Health Assembly Resolution WHA67.19 called upon WHO and Member States to improve access to palliative care as a core component of health systems, with an emphasis on PHC and community- and home-based care (197). WHO is supporting integration of palliative care into all relevant global disease control and health system plans and is promoting improved access to palliative care for children, in collaboration with the United Nations Children's Fund.

Figure 7.1. Palliative care

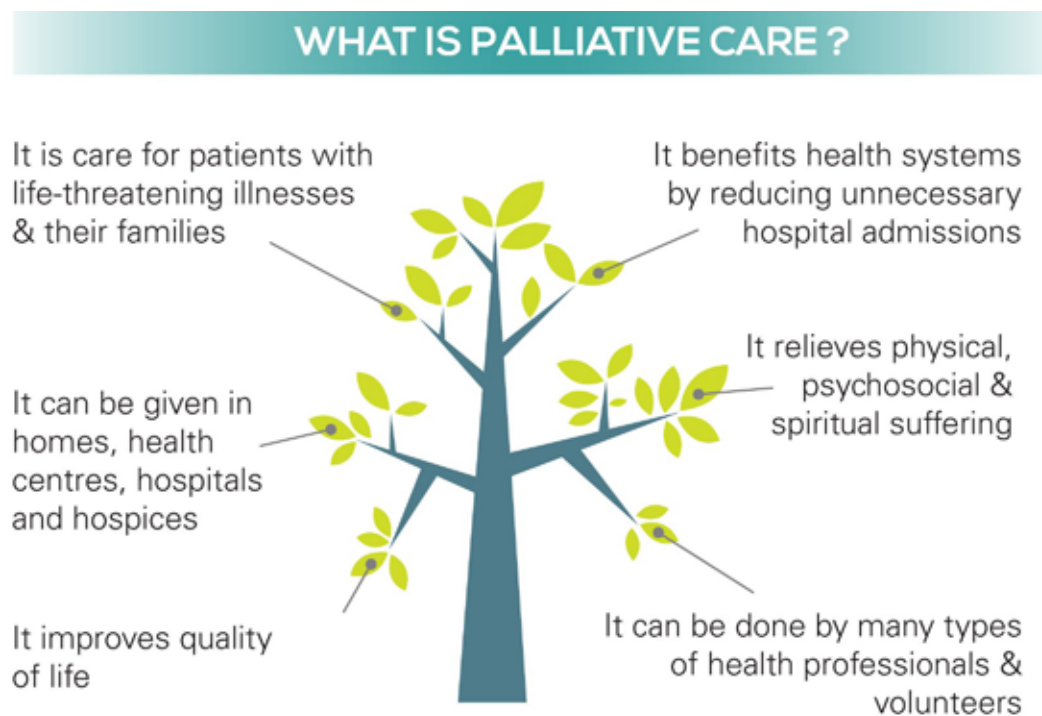

Source: https://www.who.int/images/default-source/infographics/palliative-care/infographic-palliative-care-en-final.jpg?sfvrsn=18ed19ec_4

Palliative care is an approach that improves the quality of life of people (neonates, children, adolescents, young people, adults) and their families who are facing life-threatening illness (Figure 7.1). Palliative care prevents and relieves suffering through the early identification, correct assessment and treatment of pain and other problems, whether physical, psychosocial or spiritual. Addressing suffering involves taking care of issues beyond physical symptoms. Palliative care uses a team approach to support patients and their caregivers. This includes addressing practical needs and providing bereavement counselling. It offers a support system to help people live as actively as possible until death.

Palliative care is explicitly recognized under the human right to health. It should be provided through a person- and family-centred approach through integrated health services that pay special attention to the specific needs and preferences of individuals and caregivers.

Palliative care is required for a wide range of diseases. In children, the greatest needs for palliative care are among those with HIV (29.6%); premature birth and birth trauma (17.7%); congenital malformations (16.2%); and injury, poisoning and external causes (16.0%). Of all children needing palliative care, 3.1% have TB (798).

7.3.2. Palliative care for people with TB

Palliative care for people with TB has not received adequate attention, as the focus has been on access to curative treatment. Palliative care aims to relieve suffering due to disease and illness and should be provided in conjunction with curative treatment. Although TB is curable, MDR/RR-TB (including pre-XDR and XDR-TB) is an increasing problem in many high TB burden and low- and middle-income countries, with poorer treatment outcomes reported for this group. All people with TB should be assessed for palliative care needs and these needs are greatest among people with MDR/RR-TB, some forms of EPTB (such as TBM or osteoarticular TB) and for people with comorbidities (e.g. HIV, diabetes) (799). Key to the provision of palliative care in children and adolescents with TB are the

needs of the patient, regardless of their diagnosis – for example, some children defaulting treatment may be very unwell and require palliative care (Box 7.5).

Box 7.5 Circumstances that may require palliative care in children and adolescents with TB

Situations where palliative care may be considered alongside TB treatment include:

- optimizing symptom control if the child or adolescent has distressing symptoms such as pain or breathlessness;
- advanced care planning if the child or adolescent is at risk of deterioration from the condition, considering their wishes and treatment options in advance;
- involvement of social care teams when being unwell with TB is having a significant impact on the child or adolescent and the family's social circumstances;
- the child or adolescent requires psychological support as their condition is significantly impacting their emotional or mental well-being;
- the child or adolescent is expected to die and provisions need to be made for end-of-life care, such as symptom control, spiritual care and bereavement counselling.

In November 2010, a group of experts in palliative care and MDR-TB and XDR-TB issued a declaration to expand efforts to include palliative care in the global response to MDR-TB and XDR-TB, which emphasized that access to palliative care is a human right, an essential component of TB care and that it should be strengthened (200).

Comprehensive guidelines for palliative care and support for people with TB and DR-TB were developed in 2016 (201, 202). These guidelines highlight the unique situation that TB poses for palliative care, related to the infectiousness of TB and MDR/RR-TB (including the impact on staff training and retention), indications for referral and provision of palliative care, stigma, behavioural and abuse issues, and ethical dilemmas. The guidelines recommend that symptom relief should be available to all people with TB with significant symptoms, including shortness of breath, pain, gastrointestinal dysfunction, night sweats and haemoptysis. In addition, formal palliative care should be available following a decision to discontinue TB treatment (201).

7.3.3. Palliative care for children and adolescents with TB

Palliative care for children with TB is similar to that for adults, but applied to the specific needs of this age group. While the definition and principles of palliative care described above apply to the entire lifespan, paediatric palliative care requires attention to physical, developmental, psychosocial, ethical, spiritual and relational phenomena unique to children and their families and caregivers (203). The following should be considered:

- the child's unique developmental stage and needs;
- the child's specific communication needs (e.g. sensitivity to the child's developmental stage and to language, culture and understanding of illness);
- the child's dependence on adults;
- impact of the child's severe illness on their family;
- different types of health conditions;
- need for paediatric formulations and dosing of essential medicines;
- degree of difficulty of clinical decision-making;
- requirements for the clinical environment (e.g. child-friendly, comforting).

The most common form of TB requiring palliative care in children and adolescents is DR-TB because it is associated with high morbidity and mortality. Pain, dyspnoea, nausea and vomiting are often the main physical symptoms, but stigma and isolation can result in social and spiritual pain. The family may need support to care for the child throughout the treatment period and to make preparations for end-of-life care if the prognosis is poor (204).

Integration of palliative care into existing services, such as those for children and young people with life-threatening and life-limiting illnesses, is deemed essential to improve accessibility to those who need it (204). The International Children’s Palliative Care Network stresses the need for integration of paediatric palliative care into child health services; inclusion of paediatric palliative care in relevant health, welfare and education policies; training and mentoring; and equitable access to pain-relieving and other medicines, including opioids (205). This is highlighted through the WHO conceptual model on strengthening palliative care services, which includes six components to support the development of palliative care services: supportive policies, empowered communities, research, training and education of the workforce, access to essential medicines, and integrated good-quality palliative care services (206).

Table 7.5. Actions to promote accessibility and availability of palliative care for children

Area for action	Action
Policy	Develop a national policy on children’s palliative care, with guidance on providing palliative care to children
Integration into health system	Develop national and local policies and standard operating procedures for children’s palliative care Gain management support for children’s palliative care Include human resources for provision of palliative care in planning human resources for health
Training and education	Train HCWs at basic, intermediate and specialist levels in providing palliative care to children
Access to essential medicines	Ensure essential palliative care medicines are included in the Essential Medicines List for paediatric care, are available in the country, and are accessible to children and adolescents when needed
Research	Provide data showing the impact of and need for palliative care to influence decision-makers and ensure quality of services provided
Awareness and understanding of palliative care	Develop a communication strategy and awareness campaigns to promote public understanding of palliative care This also targets policy- and decision-makers, many of whom may not be aware of the need for and impact of children’s palliative care

Although respiratory symptoms in children with life-threatening conditions such as MDR/RR-TB or advanced TB disease are common and distressing, there is very limited evidence to guide clinicians in their management. Guidelines for the management of symptoms in palliative care for children and adolescents exist, but clinicians may need to be made aware of these and may need support in managing key symptoms (Table 7.6).

Table 7.6. Examples of symptom management for children and adolescents with TB in need of palliative care (207, 208)

Symptom	Recommended management
Dyspnoea	Use of handheld fan directed at face Oxygen supplementation Oral, intravenous or subcutaneous opioids (starting at 25% of dose recommended for pain management) Integrative and supportive therapies
Cough	Over-the-counter cough medicines (e.g. honey preparations) Nebulized saline (for children with thick secretions or insufficient cough strength) Chest physiotherapy Opioids if needed (starting at 25% of dose recommended for pain management)
Haemoptysis	Antifibrinolytics as prevention or to stop haemoptysis
Retained secretions at end of life	Gentle suctioning

Source: adapted from Craig F, Henderson EM, Bluebond-Langner M. Management of respiratory symptoms in paediatric palliative care. *Curr Opin Support Palliat Care.* 2015;9(3):217–226; and Ringholz F, Devins M, McNally P. Managing end stage lung disease in children. *Paediatr Respir Rev.* 2014;15(1):75–80.

7.4. Care for adolescents with or at risk of TB

Adolescents with TB often present with bacteriologically infectious disease typical in adults (e.g. cavities seen on CXR) and therefore pose a high risk for transmission in households and congregate settings such as schools. Adolescents face unique challenges due to peer pressure and fear of stigma, increasing prevalence of comorbidities such as HIV, and risk behaviours such as use of alcohol, tobacco and other substances. People aged 10–19 years need adolescent-friendly services that include relevant psychosocial support and minimal disruption of education (5).

Age-disaggregated data on adolescent TB have been requested by WHO from countries with case-based electronic reporting systems since 2020. Data from 13 high TB burden countries that reported data in 5-year age groups (0–4 years, 5–9 years, 10–14 years, 15–19 years) to WHO for the 2021 Global TB Report show that notification rates in adolescents aged 15–19 years are relatively high compared with younger adolescents (Figure 7.2) (1).

The dynamic physical, psychological, emotional, cognitive and social development that adolescents undergo have implications for their health and well-being. Despite the specific characteristics of this age group, adolescent health data, including on TB, are often grouped together with those of younger children or adults, which means their specific needs, challenges and outcomes are not addressed.

Figure 7.2. New and relapse TB case notification rates by age group for children and adolescents in 13 high TB burden countries, 2020

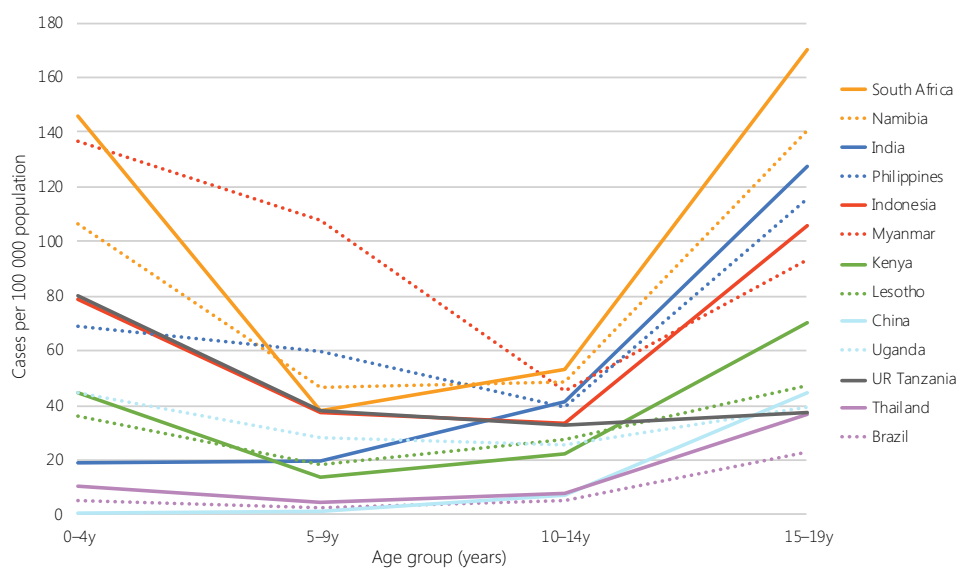

For the evidence review on the background question “How can adolescents with TB or eligible for TPT be optimally engaged in their care?” for the *WHO consolidated guidelines on the management of tuberculosis in children and adolescents*, the reviewers adapted the five domains of adolescent well-being as their theoretical framework (209): good health; connectedness and contribution to society; safety and a supportive environment; learning, competence, education, skills and employability; and agency and resilience. TB and TB treatment have negative impacts across these five domains.

7.4.1. Physical and mental health

Adolescents are at risk of TB infection, progression to TB disease, and loss to follow-up from TB care. Adolescents with MDR-TB or with TB/HIV coinfection are at particular risk of poor treatment outcomes, including death. Adherence, stigma, mental health and quality of life are impacted negatively by adverse effects of TB treatment, especially second-line treatment. Substance or alcohol use may have an impact on adverse events and TB care outcomes, although their prevalence among adolescents with TB is not known, and strategies for recognizing and managing substance or alcohol use have not been defined. Data on TB risk and outcomes for pregnant adolescents are lacking.

Specific factors related to adolescent development and vulnerabilities impact engagement of adolescents in TB prevention and treatment. Although recommended as a target group for TPT by WHO (28), adolescents are often not prioritized for TPT provision, and data on TPT uptake and completion for adolescents are seldom reported. Lower adherence to TPT has been associated with stigma, costs or challenges associated with clinic visits, and presence of risk behaviours (210, 211).

Challenges related to diagnosis or treatment for adolescents with TB are highlighted in a limited number of studies, including:

- delayed or missed diagnosis of TB in adolescents (212, 213);
- increased risk for poor adherence to TB treatment, including loss to follow-up (214–219).

Many factors that affect adolescent engagement with TB treatment have been described, including family challenges, poverty, stigma, attending work or school, and migration. Treatment fatigue and adverse effects have a negative impact on treatment adherence, particularly among adolescents with MDR/RR-TB or with TB/HIV coinfection. Adolescents often disengage from TB treatment during the continuation phase of treatment when their symptoms improve and treatment frequency decreases. Facility-based directly observed therapy is often inaccessible or unacceptable for adolescents, due

to anticipated stigma, concerns about confidentiality, travel costs, and need to attend school or work. Supportive relationships with family members, caregivers and health care providers promote treatment adherence (220).

7.4.2. Connectedness and positive contribution to society

Prolonged isolation and hospitalization have substantial psychosocial and emotional impacts on adolescents, for whom peer and family relationships are critical from a developmental standpoint. TB-related stigma impacts on adolescents' well-being and ability to engage with TB services. Family and peer relationships may, in turn, be disrupted or strained by isolation, separation or the effects of stigma.

7.4.3. Safety and a supportive environment

Adolescents with TB may experience threats to their human rights, including rights to safety, basic needs, access to health care without discrimination, protection against unnecessary hospitalization, and benefit from scientific progress. Adolescents and their families may incur devastating financial impacts, loss of income and food insecurity from TB and its treatment. Social and economic vulnerabilities increase the risk for poorer treatment outcomes, including loss to follow-up, treatment failure and death. Gender-based inequalities may be reflected in adolescent females' increased risk of HIV infection and, subsequently, TB disease (see [web annex 4](#)).

7.4.4. Learning, competence, education, skills and employability

Adolescents experience disruptions to their education due to TB and its treatment. The time needed for facility-based treatment support can interfere with education, and the need for education may in turn disrupt engagement with TB services. Disruption or delays in education may be further affected by prolonged isolation or hospitalization. As a result, TB and associated treatment may have a significant impact on adolescents' future livelihoods (see [web annex 4](#)).

7.4.5. Agency and resilience

Stigma and hierarchical models of care such as facility-based treatment may undermine adolescent agency.²⁷ Threats to social networks related to TB and its treatment and the increase in mental health challenges may impact adolescent resilience.²⁸ Some adolescents with TB, however, demonstrate resilience by forming strong relationships with peers who are on treatment or by finding a sense of purpose or meaning from their illness experience (see [web annex 4](#)).

7.4.6. Substance abuse and late presentation to care

The review identified specific challenges of providing TB care to adolescents around substance abuse, late presentation to care and treatment adherence. Adolescence is a time when individuals may engage in reward-seeking and risk-taking behaviours, including substance use. This may increase the risk of developing TB disease, more severe disease or more unfavourable treatment outcomes. Further research is required to better understand how to co-manage TB and substance use in adolescents.

There was evidence suggesting high prevalence rates, advanced disease at the time of diagnosis and underdetection of TB in adolescents, but more data are needed on the risk of late presentation and underdiagnosis in specific settings.

²⁷ Agency: the ability to make sense of the environment, initiate change, make choices and resist demands.

²⁸ Resilience: the potential for adolescents to develop positively when exposed to adversity and stress.

7.4.7. Poor adherence

Adolescents on treatment for TB disease are at risk for poor adherence in terms of missed doses and loss to follow-up. Predictors of poor treatment adherence for drug-susceptible TB include TB/HIV coinfection, age 15–19 years, prior TB treatment and male gender. For TPT, shorter regimens (e.g. 3HP or 4R) generally have higher completion rates than 6–9 months of isoniazid (see [web annex 4](#)). Qualitative studies have highlighted the importance of family support for adherence and identified why some adolescents lack support, including lack of caregiver understanding about TB, severe poverty, family conflict or neglect, and older adolescents moving away from home. Stigma is an important factor affecting adherence in adolescents. Adolescents are reported to be at particularly high risk of poor adherence during the continuation phase, when they are feeling better and the pill burden decreases (see [web annex 4](#)).

7.4.8. Making TB services more adolescent-friendly

As part of the review for the background question on adolescents, a group of experts was convened to propose actions for optimizing adolescent engagement in TB care. The proposed actions focused on two areas: reforming current practices that are harmful to adolescents with TB; and developing an adolescent-specific plan within each NTP to provide high-quality adolescent-centred TB services. [Box 7.6](#) summarizes the proposed interventions.

Box 7.6 Proposed interventions to address needs of adolescents with or at risk of TB

Reforming current practices to improve adolescent well-being:

- reporting age-disaggregated data for adolescents aged 10–14, 15–19 and 20–24 years (as currently requested by WHO for countries with case-based electronic reporting systems);
- including adolescents as a priority group for active TB case-finding, contact tracing, treatment of TB infection and TB education;
- ensuring family-oriented, community-based models of care (see [Chapter 6](#)) for adolescents, with delivery of treatment support within developmentally appropriate treatment models by CHWs or peer supporters, or by digital adherence technologies such as video supported treatment, or by trained family members or caregivers;
- minimizing isolation and hospitalization for adolescents with TB, with implementation of isolation policies on the basis of evidence for infectiousness (e.g. allowing adolescents to go back to school or higher education, vocational training or work as soon as they are no longer infectious and appropriate support and treatment adherence structures are in place);
- prioritization of adolescents (especially those aged under 18 years) in clinical trials and observational studies of treatments for infection and disease caused by drug-susceptible and DR-TB, and research on TB diagnostics;
- implementation of the shortest possible effective TPT and TB treatment regimens for adolescents to facilitate adherence and minimize interference with education and other developmental tasks;
- discussions on adverse effects of first- or second-line treatment, including consideration of the acceptability to adolescents of a medicine's potential adverse effects with adolescents and their caregivers before starting treatment;
- counselling of adolescents on contraception methods.

WHO has established standards that are equitable, accessible, acceptable, appropriate and effective for good-quality adolescent health services (221, 222). Ideally, planning for the implementation of these standards is overseen by expert committees in TB care and adolescent health, adolescents and young adults who have been treated for TB and their families, and youth advocates. Assessing current gaps and barriers to delivering good-quality adolescent health care within TB programmes is a first step in the development process. Age-disaggregated TB data and indicators, and existing adolescent-friendly models of care for HIV, sexual and reproductive health, and other health conditions can inform the plans. The next steps in the planning cycle are monitoring of the implementation of adolescent-oriented plans and integrating this into national reporting processes.

The following setting-specific components can be included in national plans to improve adolescent TB services:

- Ensure management of adolescents by providers who are knowledgeable and skilled in caring for this age group. Carry out regular training of TB clinicians, nurses and multidisciplinary staff in adolescent health, with the goal of better understanding and responding to the needs, values and preferences of adolescents, and providing confidential, nonjudgemental, destigmatizing care.
- Train general and specialist health care providers to increase their awareness of adolescent-specific risks with respect to TB, and appropriate use of TB screening, diagnostics and referral.
- Increase adolescents' access to TB services by offering after-school and weekend clinic hours; minimizing clinic waiting times for adolescents; providing community-based or decentralized TB care for adolescents; and facilitating easy transfer between TB care sites when adolescents need to relocate, such as for school, work or changing living situations.
- Actively identify wider health care needs of adolescents with TB by integrating TB care with other health services, such as within comprehensive adolescent health clinics. In the absence of co-located services, ensure clear referral pathways for common health concerns such as reproductive health care, prenatal care, HIV care, treatment of substance use disorders, immunization and mental health care.
- Provide education and youth-friendly information that is accessible to adolescents, their caregivers and the general public, with the goal of reducing TB-related stigma and increasing public awareness about adolescents' susceptibility to TB, TB symptoms, and ways to access TB testing.
- Address the psychosocial and mental health needs of adolescents with TB, including risks for depression and substance use. Interventions to prevent common mental disorders (e.g. depression and anxiety) can promote social connectedness. Consider routine screening for mental health disorders, provision of counselling and other forms of psychological support, employment of trained peer counsellors, and formation of peer support groups.
- Empower caregivers to effectively support adolescent TB treatment, including education, counselling, and identifying and addressing family or caregiver needs such as financial hardship.
- Collaborate with the education sector to develop policies that promote school engagement and retention of students with TB, facilitate TB screening and contact tracing, and provide adherence support for TB treatment if needed for students at school. Actively engage with local schools to build student understanding of TB and support schools to be able to practically and positively respond to students with TB.
- Collaborate with other sectors to address basic needs for adolescents with TB and their families. These may relate to catastrophic financial impacts (direct and indirect) of TB and its treatment on basic needs, including food security, and need for adolescents to continue education.

7.5. TB in children with severe acute pneumonia

TB is a common cause or comorbidity in children with clinically diagnosed pneumonia. A systematic review on TB in acute respiratory infection found that *M. tuberculosis* was identified in around 5–10% of children with pneumonia aged under 5 years in TB endemic countries (223). Limited data from clinical and autopsy studies suggest that TB was also associated with mortality in these children. Prevalence studies, including the multisite PERCH study (224), confirm these findings.

The review found that clinical features, including persistence of symptoms, had low specificity for diagnosis of TB in young children presenting with pneumonia. TB presents with acute and severe symptoms of pneumonia, which cannot be distinguished (clinically or radiographically) from other causes of pneumonia. Young age and history of a close or household TB contact are known important risk factors for TB in children presenting with pneumonia. However, only a minority of children diagnosed with bacteriologically confirmed TB had a reported close contact. Poor nutritional status increased risk of pneumonia of all causes and is recognized as both a feature of and a risk factor for TB. There were insufficient recent data to determine the current relative risk of TB presenting with pneumonia in children living with HIV.

TB may contribute to treatment failure in children with pneumonia, often following an initial clinical response to empirical antibiotic treatment for pneumonia, presumably because of coinfection with pathogens susceptible to those antibiotics, such as *Streptococcus pneumoniae*. Therefore, children with pneumonia who have prolonged symptoms, history of TB contact, treatment failure or recurrent pneumonia must be evaluated for TB disease. Box 7.7 summarizes implications for implementation.

Box 7.7 Implications for implementation

- Consideration of TB should continue to be included as part of child pneumonia guidelines, particularly in high TB burden settings.
- Children with pneumonia who have prolonged symptoms, TB contact, treatment failure or recurrent pneumonia must be evaluated for TB disease. Bacteriological confirmation should be sought whenever feasible in children with pneumonia who are evaluated for TB disease. The [treatment decision algorithms in Chapter 4](#) may be used in children with pneumonia.
- Children with TB who present with severe pneumonia often lack distinguishing clinical or radiological features of TB at presentation and may initially respond to empirical antibiotics. Post-discharge follow-up assessment of children with severe pneumonia provides an opportunity to identify and treat coexisting TB.
- Children with severe pneumonia who are diagnosed with TB should be treated with a 6-month regimen as they present with severe disease. No data on shortening treatment in children with severe pneumonia were available.

Source: Stakeholder consultative meeting on prevention and management of childhood pneumonia and diarrhoea. Geneva: World Health Organization Department of Maternal, Newborn, Child and Adolescent Health and Ageing, 12–14 October 2021 (<https://www.who.int/publications/i/item/9789240046702>).

Box 7.8 Findings from the TB-Speed Pneumonia study

Setting and methods The TB-Speed Pneumonia study was an international pragmatic cluster-randomized diagnostic trial conducted in 15 tertiary hospitals across 6 countries with high TB incidence (Cambodia, Cameroon, Côte d'Ivoire, Mozambique, Uganda, Zambia). It aimed to assess the impact on mortality of adding systematic molecular TB detection using the Xpert MTB/RIF Ultra (Ultra) assay performed on one NPA sample and one stool sample to the standard of care recommended by WHO for children with severe pneumonia. The trial also assessed the feasibility and TB detection yield of the Xpert Ultra on NPA and stool samples.

In both study arms, all children aged under 5 years newly hospitalized with WHO-defined severe pneumonia received care and treatment planned according to the routine WHO standard of care for young children with severe pneumonia, which includes a course of broad-spectrum antibiotics, oxygen when indicated, and treatment of comorbidities such as HIV and severe malnutrition.

In the intervention arm, in addition to the WHO standard of care, children had NPA and stool samples performed on the day of hospital admission and tested with Ultra. The sample flow was organized to reduce the time to results to 3 hours.

All children with Ultra-positive results were started on treatment immediately. Children were followed for 12 weeks after enrolment (day 3, hospital discharge, 2 weeks post-discharge, week 12).

Results A total of 2570 children were enrolled in the study (1401 control arm, 1169 intervention arm) between March 2019 and March 2021, with a 6-month period of interruption of enrolments in 2020 due to the COVID-19 pandemic. The median age was 11 months in both arms. Overall, 5% of the children were living with HIV. SAM was more frequent in the intervention arm (25.8%) than the control arm (17.1%). Pneumonia was slightly more severe in the control arm, with lower median oxygen saturation at enrolment (92%) compared with the intervention arm (94%). Overall, 87 (7.4%) and 71 (5.1%) children were initiated on TB treatment in the control and intervention arms, respectively ($p=0.012$). In the intervention arm, 97.4% and 82.2% of children had NPA and stool samples collected, respectively, and 2.1% had a positive Ultra result. At 12 weeks, 90 children (7.7%) had died in the intervention arm versus 100 (7.9%) in the control arm. Statistical analysis showed that the intervention was not associated with decreased mortality (aOR 0.95, 95% CI 0.58–1.58).

Conclusions Screening with Ultra at the time of admission did not lead to reduced mortality in children with severe pneumonia. Deaths occurred generally very early in the follow-up period, and these may not have been averted by the intervention, even if effective. Microbiological sample collection and Ultra testing had a high feasibility of combined NPA and stool samples but a low yield overall. The high proportion of children started on TB treatment and the relatively high microbiological confirmation rate support the more systematic use of Ultra in this vulnerable group.

Vessièrè A, Font H, Gabillard D, et al. (2021). Impact of systematic early tuberculosis detection using Xpert MTB/RIF Ultra in children with severe pneumonia in high tuberculosis burden countries (TB-Speed pneumonia): a stepped wedge cluster randomized trial. *BMC Pediatrics* 21(1): 136 (225).

Marcy O, Font H, Vessière A, et al., for the TB Speed Pneumonia Study Group. Impact of systematic TB detection using Xpert Ultra on nasopharyngeal aspirates and stool samples on mortality in children with severe pneumonia. Presentation. Paris: International Union Against Tuberculosis and Lung Disease, 2021 (226).

TB-Speed Pneumonia: results of an international cluster randomized trial on systematic tuberculosis detection in children with severe pneumonia. TB-Speed, 25 October 2021 (https://www.tb-speed.com/wp-content/uploads/2021/10/TB-Speed_Pneumonia_Study_Press_Release_20211021-.pdf) (227).

7.6. Management of children with TB and malnutrition

7.6.1. Introduction

By reducing cell-mediated immunity, undernutrition increases the risk of TB, while the catabolic effect of TB disease results in weight loss and wasting, creating a vicious cycle (105, 228). Globally, about 45% of deaths in children aged under 5 years are attributable to undernutrition (228). Undernutrition may be acute or chronic and categorized as moderate or severe. Data from the 2021 Global Tuberculosis Report suggest that 1.9 million TB cases per year (19%) are attributable to undernourishment (7). Data on TB prevalence among acutely malnourished children show a wide variety of prevalence levels, with 2–24% of acutely malnourished children in high TB burden settings diagnosed with TB (229).

A review of guidelines on acute malnutrition showed that TB screening is not consistently included in guidelines for acute malnutrition in high TB burden countries (229). Routine TB risk assessment, especially history of TB exposure, among acutely malnourished children, combined with improved referral linkages with TB services, could help increase TB case-finding and improve outcomes. Integration and coordination between TB and nutrition services are important to ensure children and adolescents with malnutrition are routinely evaluated for TB (5). Integrated models of care are covered in [Chapter 6](#).

7.6.2. Diagnosis and treatment of TB in children with malnutrition

Children and adolescents with TB disease frequently present with failure to thrive or weight loss (see [Chapter 4](#)). Severe malnutrition is one of the key risk factors for TB in children. Children receiving therapeutic nutritional treatment or nutritional supplementation but still not gaining weight, or continuing to lose weight, should be considered as having a chronic disease such as TB and evaluated accordingly (6). Malnutrition may cause a false-negative TST through its impact on the cell-mediated immune response (6, 230).

SAM puts a child at high risk of rapid progression of TB disease (see [Chapter 4](#)). When using the integrated treatment decision algorithms, a child with SAM (defined as weight-for-height Z-score of less than -3) should be assessed using all steps of Algorithm A or B (depending on availability of CXR), including the scoring section. If available, an mWRD (Xpert MTB/RIF or Ultra) or LF-LAM if the child is also living with HIV should be done and treatment started if the test is positive. If the child has a documented contact with a person with bacteriologically confirmed TB, the child should be started on TB treatment as well. In the absence of a TB contact, if the total score from signs and symptoms (and CXR if applicable) is more than 10, a decision to start TB treatment should be made.

Severely malnourished children with a decision to start TB treatment should be started on a 6-month course of treatment (2HRZ(E)/4HR). These children should not be treated with the 4-month treatment regimen as there was limited evidence in the SHINE trial on this subgroup (3, 86). If there is a high likelihood of DR-TB, they should be started on a second-line treatment regimen or referred to the appropriate level of care. Children and adolescents living with HIV who have TB who are severely malnourished have a high risk for a poor treatment response and mortality and should be monitored closely (6).

7.6.3. Nutritional care for children and adolescents with TB

WHO provides guidance on the principles²⁹ and recommendations for nutritional care and support of people with TB as part of their regular TB care.

Five guiding principles are key for providing nutritional care and support as an integral part of TB care and prevention (105):

- All people with TB disease should receive TB diagnosis, treatment and care according to WHO guidelines and international standards of care. When malnutrition is identified at the time of TB diagnosis, TB is considered a key causal factor that needs to be addressed. It is essential that nutrition assessment and assistance do not divert resources from optimal TB diagnosis and care. Concerns about weight loss or failure to gain weight during TB treatment should trigger further clinical assessment (e.g. resistance to TB medicines, poor adherence, comorbidities) and nutritional assessment of the causes of undernutrition to determine the most appropriate interventions.
- An adequate diet containing all essential macro- and micronutrients is necessary for the well-being and health of all people, including those with TB infection or TB disease.
- Because of the clear bidirectional causal link between undernutrition and TB disease, nutrition screening, assessment and management are integral components of TB treatment and care.
- Poverty and food insecurity are both causes and consequences of TB. Providers involved in TB care play an important role in recognizing and addressing these wider socioeconomic issues.
- TB is commonly accompanied by comorbidities such as HIV, diabetes mellitus, smoking, and alcohol or substance use, which have their own nutritional implications. These should be considered fully during nutrition screening, assessment and counselling.

People with TB should be nutritionally assessed and receive the same nutritional care and support as other people of similar nutritional status, in agreement with all relevant WHO recommendations.

The recommendations are grouped in four areas related to nutritional care and support to cover especially vulnerable populations, with an additional area for contact investigation (Box 7.9).

²⁹ A guiding principle in health is a rule that has to be followed, or that may be desirable to follow, and that cannot be proved or contradicted unless propositions are made that are even clearer. It is a comprehensive and fundamental law, doctrine or assumption guiding health care and is understood by its users as the essential characteristics of health care and its designed purpose. A respect of the principles is needed for the health care to be used effectively. A guiding principle reflects a set of values that contextualize the provision of care in programmatic settings. Such values cannot be subjected to formal research but reflect preferences regarding public health approaches and goals. The principles are intended to inform and assist national technical groups and international and regional partners providing health care.

Box 7.9 WHO recommendations related to nutritional care and support

Nutrition assessment and counselling

All individuals with TB disease should receive (i) an assessment of their nutritional status and (ii) appropriate counselling based on their nutritional status at diagnosis and throughout treatment (*strong recommendation, certainty of evidence not available*).

Management of severe acute malnutrition

School-age children and adolescents (5–19 years) and adults, including pregnant and lactating women, with TB disease and severe acute malnutrition should be treated in accordance with the WHO recommendations for management of severe acute malnutrition (*strong recommendation, very low certainty of evidence*).

Children who are less than 5 years of age with TB disease and severe acute malnutrition should be treated in accordance with the WHO recommendations for the management of severe acute malnutrition in children who are less than 5 years of age (*strong recommendation, very low certainty of evidence*).

Management of moderate undernutrition

School-age children and adolescents (5–19 years) and adults, including lactating women, with TB disease and moderate undernutrition, who fail to regain normal body mass index after 2 months' TB treatment, as well as those who are losing weight during TB treatment, should be evaluated for adherence and comorbid conditions. They should also receive nutrition assessment and counselling and, if indicated, be provided with locally available nutrient-rich or fortified supplementary foods, as necessary to restore normal nutritional status (*conditional recommendation, low certainty of evidence*).

Children who are less than 5 years of age with TB disease and moderate undernutrition should be managed as any other children with moderate undernutrition. This includes provision of locally available nutrient rich or fortified supplementary foods, in order to restore appropriate weight-for-height (*strong recommendation, very low certainty of evidence*).

Patients with multidrug-resistant TB and moderate undernutrition should be provided with locally available nutrient-rich or fortified supplementary foods, as necessary to restore normal nutritional status (*strong recommendation, very low certainty of evidence*).

A daily multiple micronutrient supplement at 1× recommended nutrient intake should be provided in situations where fortified or supplementary foods should have been provided in accordance with standard management of moderate undernutrition^a but are unavailable (*conditional recommendation, very low certainty of evidence*).

Contact investigation

In settings where contact tracing is implemented, household contacts of people with TB disease should have a nutrition screening and assessment as part of contact investigation. If malnutrition is identified, it should be managed according to WHO recommendations (*conditional recommendation, very low certainty of evidence*).

Remarks:

There is no evidence that nutritional management of acute malnutrition of people with TB disease should be different from that for those without TB disease.

Concerns about weight loss or failure to gain weight should trigger further clinical assessment (e.g. resistance to TB medicines, poor adherence, comorbidities) and nutrition assessment to determine the most appropriate interventions.

Closer nutritional monitoring and earlier initiation of nutrition support (before the first 2 months of TB treatment are completed) should be considered if the nutritional indicator is approaching the cut-off value for a diagnosis of severe undernutrition.

^a Pyridoxine supplementation is recommended along with isoniazid treatment for all pregnant (or breastfeeding) women, and for people with conditions such as HIV, alcohol dependency, malnutrition, diabetes, chronic liver disease and renal failure. Pyridoxine provision together with isoniazid treatment was not analysed for the 2013 *WHO guideline: nutritional care and support for patients with tuberculosis*.

Source: Guideline: nutritional care and support for patients with tuberculosis. Geneva: World Health Organization; 2013 (https://apps.who.int/iris/bitstream/handle/10665/94836/9789241506410_eng.pdf) (105).

The nutritional status of children and adolescents with TB should be assessed regularly during TB treatment. All children and adolescents diagnosed with TB who do not meet criteria for treatment of SAM still require nutritional support. This includes efforts to continue breastfeeding (at least until age 24 months where possible) and to ensure adequate nutrient intake using locally available and affordable foods. Additional energy (up to 20–30% more calories) is important during the intensive phase of treatment and is simplest to provide through additional household foods as part of a balanced varied diet. A clear explanation and advice to the caregiver is important. Where it is not possible to meet the needs with household food, the child or adolescent can be provided with nutritional supplements (e.g. ready-to-use therapeutic food) until stabilized.

Infants aged under 6 months with malnutrition or growth failure require referral to a therapeutic feeding programme to receive a special formulated mixture of protein, carbohydrate, lipid, vitamins and minerals, as do children of other ages with severe malnutrition. If therapeutic feeding is not available or feasible, breastfeeding mothers should be given nutritional support to optimize breastfeeding.

Key messages

Management of TB in children and adolescents living with HIV

- Children and adolescents living with HIV have an increased risk of TB exposure, infection, progression to disease, and TB-related morbidity and mortality.
- The increased risk warrants specific approaches to TB screening, TPT, and diagnosis and management of TB, with adaptations of tools and treatment regimens to avoid drug–drug interactions between ART and TB medicines.
- In children and adolescents with TB/HIV coinfection, ART should be started as soon as possible within 2 weeks of initiating TB treatment.

Management of TB in pregnancy and newborns of mothers with TB disease

- TB in pregnancy is associated with adverse maternal outcomes and complications during birth, and increased risk of premature birth, low birthweight and perinatal death.
- Pregnant and postpartum women are a risk group to be considered for TB screening. Pregnant women living with HIV are a key population for TB screening.
- Congenital TB (acquired in utero) and neonatal TB (acquired after birth through close contact, usually the mother) should be considered in neonates with chronic infection with a poor response to antibiotics, especially if the mother has a history of TB or HIV.
- Well neonates born to mothers with TB disease should receive TPT and delay BCG vaccination until after completion of TPT.

Palliative care for children and adolescents with TB

- Palliative care is an approach that improves the quality of life of people of all ages facing life-threatening illness, and their families.
- Palliative care is recognized as a human right to health and should be provided through a person- and family-centred approach through integrated health services.
- Palliative care for children and adolescents with TB involves symptom control, advanced care planning, involvement of social care teams, psychological support and end-of-life care, including pain relief.

Care for adolescents with or at risk of TB

- Adolescents with TB usually present with adult-type disease.
- This age group faces unique challenges due to peer pressure and fear of stigma, increasing prevalence of comorbidities such as HIV, and risk behaviours such as use of alcohol, tobacco and other substances.
- To make TB services more adolescent-friendly, some practices need to be reformed to improve adolescent well-being.

Management of TB in children with pneumonia

- TB is a cause or comorbidity in 5–10% of children aged under 5 years with severe acute pneumonia in TB endemic countries.
- Consideration of TB should continue to be included as part of child pneumonia guidelines, particularly in high TB burden settings.
- Children with pneumonia who have prolonged symptoms, treatment failure or recurrent pneumonia should be evaluated for TB disease. Bacteriological confirmation should be sought whenever feasible.

- Children with TB who present with severe pneumonia often lack distinguishing clinical or radiological features of TB at presentation and may initially respond to empirical antibiotics. Post-discharge follow-up assessment of children with severe pneumonia provides an opportunity to identify and treat coexisting TB.

Management of children with TB and malnutrition

- Undernutrition increases the risk of TB, and the catabolic effect of TB disease results in weight loss and wasting.
- Severe malnutrition is one of the key risk factors for TB in children. Children who are receiving therapeutic nutritional treatment or supplementation but still not gaining weight should be evaluated for TB.
- Children with SAM should be treated with a 6-month treatment regimen.
- Recommendations exist on nutritional assessment and counselling and nutritional supplementation or management of SAM for children with TB who have moderate or severe malnutrition.

8. References

1. Global tuberculosis report 2021. Geneva: World Health Organization; 2021 (<https://apps.who.int/iris/handle/10665/346387>, accessed 1 December 2021).
2. Snow KJ, Sismanidis C, Denholm J, et al. The incidence of tuberculosis among adolescents and young adults: a global estimate. *Eur Respir J*. 2018;51(2):1702352.
3. WHO consolidated guidelines on tuberculosis. Module 5: management of tuberculosis in children and adolescents. Geneva: World Health Organization; 2022 (<https://apps.who.int/iris/bitstream/handle/10665/352522/9789240046764-eng.pdf>).
4. Marais B. The natural history of childhood intra-thoracic tuberculosis: a critical review of literature from the pre-chemotherapy era. *Int J Tuberc Lung Dis*. 2004;8(4):392–402.
5. Roadmap towards ending TB in children and adolescents. Geneva: World Health Organization; 2018 (<https://apps.who.int/iris/handle/10665/275422>, accessed 1 December 2021).
6. Guidance for national tuberculosis programmes on the management of tuberculosis in children, second edition. Geneva: World Health Organization; 2014 (<https://apps.who.int/iris/handle/10665/112360>, accessed 1 December 2021).
7. The End TB Strategy: global strategy and targets for tuberculosis prevention, care and control after 2015. Geneva: World Health Organization; 2014 (<https://apps.who.int/iris/handle/10665/162760>, accessed 1 December 2021).
8. The Sustainable Development Agenda. New York: United Nations (<https://www.un.org/sustainabledevelopment/development-agenda/>, accessed 1 December 2021).
9. Political declaration of the UN General-Assembly High-level meeting on the fight against tuberculosis. New York: United Nations; 2018 (https://www.who.int/docs/default-source/documents/tuberculosis/political-declaration-un-general-assembly-tb-tuberculosis.pdf?sfvrsn=4f4090dc_1&download=true, accessed 1 December 2021).
10. Houben R, Lalli M, Kranzer K, et al. What if they don't have tuberculosis? The consequences and trade-offs involved in false-positive diagnoses of tuberculosis. *Clin Infect Dis*. 2019;68(1):150–156.
11. Dodd PJ, Gardiner E, Coghlan R, Seddon JA. Burden of childhood tuberculosis in 22 high-burden countries: a mathematical modelling study. *Lancet Glob Health*. 2014;2(8):e453–e459.
12. Dodd PJ, Sismanidis C, Seddon JA. Global burden of drug-resistant tuberculosis in children: a mathematical modelling study. *Lancet Infect Dis*. 2016;16(10):1193–1201.
13. WHO operational handbook on tuberculosis. Module 2: screening – systematic screening for tuberculosis disease. Geneva: World Health Organization; 2021 (<https://apps.who.int/iris/handle/10665/340256>, accessed 1 December 2021).
14. WHO consolidated guidelines on tuberculosis. Module 2: screening – systematic screening for tuberculosis disease. Geneva: World Health Organization; 2021 (<https://apps.who.int/iris/handle/10665/340255>, accessed 1 December 2021).
15. WHO operational handbook on tuberculosis. Module 1: prevention – tuberculosis preventive treatment. Geneva: World Health Organization; 2020 (<https://apps.who.int/iris/handle/10665/331525>, accessed 1 December 2021).
16. Martinez L, Cords O, Horsburgh CR, et al. The risk of tuberculosis in children after close exposure: a systematic review and individual-participant meta-analysis. *Lancet*. 2020;395(10228):973–984.

17. Dodd PJ, Yuen CM, Sismanidis C, et al. The global burden of tuberculosis mortality in children: a mathematical modelling study. *Lancet Glob Health*. 2017;5(9):e898–e906.
18. Gupta A, Swindells S, Kim S, et al. Feasibility of identifying household contacts of rifampin- and multidrug-resistant tuberculosis cases at high risk of progression to tuberculosis disease. *Clin Infect Dis*. 2020;70(3):425–435.
19. Lung T, Marks GB, Nhung NV, et al. Household contact investigation for the detection of tuberculosis in Vietnam: economic evaluation of a cluster-randomised trial. *Lancet Glob Health*. 2019;7(3):e376–e384.
20. Sulis G, Combarry A, Getahun H, et al. Implementation of tuberculosis prevention for exposed children, Burkina Faso. *Bull World Health Org*. 2018;96(6):386–392.
21. Kay AW, Sandoval M, Mtetwa G, et al. Vikela Ekaya: a novel, community-based, tuberculosis contact management program in a high burden setting. *Clin Infect Dis*. 2021; (<https://doi.org/10.1093/cid/ciab652>, accessed 1 December 2021).
22. Recommendations for investigating contacts of persons with infectious tuberculosis in low- and middle-income countries. Geneva: World Health Organization; 2012 (<https://apps.who.int/iris/handle/10665/77741>, accessed 1 December 2021).
23. Padyana M, Bhat RV, Dinesha M, Nawaz A. HIV-tuberculosis: a study of chest X-ray patterns in relation to CD4 count. *N Am J Med Sci*. 2012;4(5):221–225.
24. Colditz GA, Berkey CS, Mosteller F, et al. The efficacy of bacillus Calmette-Guérin vaccination of newborns and infants in the prevention of tuberculosis: meta-analyses of the published literature. *Pediatrics*. 1995;96(1 Pt 1):29–35.
25. Vonasek B, Ness T, Takwoingi Y, et al. Screening tests for active pulmonary tuberculosis in children. *Cochrane Database Syst Rev*. 2021;6(6):CD013693.
26. WHO consolidated guidelines on tuberculosis. Module 3: diagnosis – rapid diagnostics for tuberculosis detection, 2021 update. Geneva: World Health Organization; 2021 (<https://apps.who.int/iris/handle/10665/342331>, accessed 1 December 2021).
27. Use of tuberculosis interferon-gamma release assays (IGRAs) in low- and middle-income countries: policy statement. Geneva: World Health Organization; 2011 (<https://apps.who.int/iris/handle/10665/44759>, accessed 1 December 2021).
28. WHO consolidated guidelines on tuberculosis. Module 1: prevention – tuberculosis preventive treatment. Geneva: World Health Organization; 2020 (<https://apps.who.int/iris/handle/10665/331170>, accessed 1 December 2021).
29. Colditz GA, Brewer TF, Berkey CS, et al. Efficacy of BCG vaccine in the prevention of tuberculosis: meta-analysis of the published literature. *JAMA*. 1994;271(9):698–702.
30. Blok L, Sahu S, Creswell J, et al. Comparative meta-analysis of tuberculosis contact investigation interventions in eleven high burden countries. *PLoS One*. 2015;10(3):e0119822.
31. BCG vaccines: WHO position paper – February 2018. Geneva: World Health Organization; 2018 (<https://apps.who.int/iris/handle/10665/260307>, accessed 1 December 2021).
32. Prentice S, Nassanga B, Webb EL, et al. BCG-induced non-specific effects on heterologous infectious disease in Ugandan neonates: an investigator-blind randomised controlled trial. *Lancet Infect Dis*. 2021;21(7):993–1003.
33. Information sheet: observed rate of vaccine reactions – bacille Calmette-Guérin (BCG) vaccine. Geneva: World Health Organization; 2012.
34. Hesselning AC, Johnson LF, Jaspan H, et al. Disseminated bacille Calmette-Guérin disease in HIV-infected South African infants. *Bull World Health Organ*. 2009;87(7):505–511.

35. Cuello-Garcia CA, Perez-Gaxiola G, Jimenez Gutierrez C. Treating BCG-induced disease in children. *Cochrane Database Syst Rev.* 2013;(1):CD008300.
36. Hesselning AC, Rabie H, Marais BJ, et al. Bacille Calmette-Guérin vaccine-induced disease in HIV-infected and HIV-uninfected children. *Clin Infect Dis.* 2006;42(4):548–558.
37. Venkataraman A, Yusuff M, Liebeschuetz S, et al. Management and outcome of Bacille Calmette-Guerin vaccine adverse reactions. *Vaccine.* 2015;33(41):5470–5474.
38. Curtis N, Sparrow A, Ghebreyesus TA, Netea MG. Considering BCG vaccination to reduce the impact of COVID-19. *Lancet.* 2020;395(10236):1545–1546.
39. Fritschi N, Curtis N, Ritz N. Bacille Calmette Guerin (BCG) and new TB vaccines: specific, cross-mycobacterial and off-target effects. *Paediatr Respir Rev.* 2020;36:57–64.
40. Marais BJ, Seddon JA, Detjen AK, et al. Interrupted BCG vaccination is a major threat to global child health. *Lancet Respir Med.* 2016;4(4):251–253.
41. Kontturi A, Santiago B, Tebruegge M, et al. The impact of Bacille Calmette-Guérin shortage on immunisation practice and policies in Europe: a Paediatric Tuberculosis Network European Trials Group (ptbnet) survey. *Tuberculosis (Edinb).* 2016;101:125–129.
42. Du Preez K, Seddon JA, Schaaf HS, et al. Global shortages of BCG vaccine and tuberculous meningitis in children. *Lancet Glob Health.* 2019;7(1):e28–e29.
43. Cernuschi T, Malvolti S, Nickels E, Friede M. Bacillus Calmette-Guerin (BCG) vaccine: a global assessment of demand and supply balance. *Vaccine.* 2018;36(4):498–506.
44. Global market study: BCG vaccine. Geneva: World Health Organization; 2019 (https://www.who.int/immunization/programmes_systems/procurement/v3p/platform/module2/WHO_BCG_vaccine_global_market_update_Feb2019.pdf, accessed 1 December 2021).
45. Bacille Calmette-Guérin (BCG) vaccination and COVID-19: scientific brief – 12 April 2020. Geneva: World Health Organization; 2020 (<https://apps.who.int/iris/handle/10665/331745>, accessed 1 December 2021).
46. Dodd PJ, Prendergast AJ, Beecroft C, et al. The impact of HIV and antiretroviral therapy on TB risk in children: a systematic review and meta-analysis. *Thorax.* 2017;72(6):559–575.
47. Ford N, Matteelli A, Shubber Z, et al. TB as a cause of hospitalization and in-hospital mortality among people living with HIV worldwide: a systematic review and meta-analysis. *J Int AIDS Soc.* 2016;19(1):20714.
48. Badje A, Moh R, Gabillard D, et al. Effect of isoniazid preventive therapy on risk of death in west African, HIV-infected adults with high CD4 cell counts: long-term follow-up of the Temprano ANRS 12136 trial. *Lancet Glob Health.* 2017;5(11):e1080–e1089.
49. Guidelines for intensified tuberculosis case-finding and isoniazid preventative therapy for people living with HIV in resource-constrained settings. Geneva: World Health Organization; 2011 (<https://apps.who.int/iris/handle/10665/44472>, accessed 1 December 2021).
50. Bruins WS, van Leth F. Effect of secondary preventive therapy on recurrence of tuberculosis in HIV-infected individuals: a systematic review. *Infect Dis (Lond).* 2017;49(3):161–169.
51. Cotton MF, Schaaf HS, Lottering G, et al. Tuberculosis exposure in HIV-exposed infants in a high-prevalence setting. *Int J Tuberc Lung Dis.* 2008;12(2):225–227.
52. Cranmer LM, Kanyugo M, Jonnalagadda SR, et al. High prevalence of tuberculosis infection in HIV-1 exposed Kenyan infants. *Pediatr Infect Dis J.* 2014;33(4):401–406.
53. Kali PB, Gray GE, Violari A, et al. Combining PMTCT with active case finding for tuberculosis. *J Acquir Immune Defic Syndr.* 2006;42(3):379–381.
54. Sterling TR, Alwood K, Gachuhi R, et al. Relapse rates after short-course (6-month) treatment of tuberculosis in HIV-infected and uninfected persons. *Aids.* 1999;13(14):1899–1904.

55. Vernon A, Burman W, Benator D, et al. Acquired rifamycin mono-resistance in patients with HIV-related tuberculosis treated with once-weekly rifapentine and isoniazid. *Tuberculosis Trials Consortium. Lancet.* 1999;353(9167):1843–1847.
56. Small PM, Shafer RW, Hopewell PC, et al. Exogenous reinfection with multidrug-resistant *Mycobacterium tuberculosis* in patients with advanced HIV infection. *N Engl J Med.* 1993;328(16):1137–1144.
57. Crampin AC, Mwaungulu JN, Mwaungulu FD, et al. Recurrent TB: relapse or reinfection? The effect of HIV in a general population cohort in Malawi. *AIDS.* 2010;24(3):417–426.
58. Narayanan S, Swaminathan S, Supply P, et al. Impact of HIV infection on the recurrence of tuberculosis in South India. *J Infect Dis.* 2010;201(5):691–703.
59. Chaisson RE, Churchyard GJ. Recurrent tuberculosis: relapse, reinfection, and HIV. *J Infect Dis.* 2010;201(5):653–655.
60. Naidoo K, Dookie N. Insights into recurrent tuberculosis: relapse versus reinfection and related risk factors. In Kayembe J-M, editor. *Tuberculosis.* London: IntechOpen; 2018 (<https://www.intechopen.com/books/tuberculosis/insights-into-recurrent-tuberculosis-relapse-versus-reinfection-and-related-risk-factors>, accessed 1 December 2021).
61. Latent tuberculosis infection: updated and consolidated guidelines for programmatic management. Geneva: World Health Organization; 2018 (<https://apps.who.int/iris/handle/10665/260233>, accessed 8 March 2022).
62. TB elimination: interferon-gamma release assays (IGRAs) – blood tests for TB infection. Atlanta, GA: Centers for Disease Control and Prevention (<https://www.cdc.gov/tb/publications/factsheets/testing/IGRA.pdf>, accessed 1 December 2021).
63. Getahun H, Matteelli A, Chaisson RE, Raviglione M. Latent *Mycobacterium tuberculosis* infection. *N Engl J Med.* 2015;372(22):2127–2135.
64. Salgame P, Geadas C, Collins L, et al. Latent tuberculosis infection: revisiting and revising concepts. *Tuberculosis (Edinb).* 2015;95(4):373–384.
65. Schwoebel V, Koura KG, Adjobimey M, et al. Tuberculosis contact investigation and short-course preventive therapy among young children in Africa. *Int J Tuberc Lung Dis.* 2020;24(4):452–460.
66. Report of the meeting to review the paediatric antituberculosis drug optimization priority list. Geneva: World Health Organization; 2021 (<https://apps.who.int/iris/handle/10665/340316>, accessed 1 December 2021).
67. Becerra MC, Huang C-C, Lecca L, et al. Transmissibility and potential for disease progression of drug resistant *Mycobacterium tuberculosis*: prospective cohort study. *BMJ.* 2019;367:l5894.
68. Marks SM, Mase SR, Morris SB. Systematic review, meta-analysis, and cost-effectiveness of treatment of latent tuberculosis to reduce progression to multidrug-resistant tuberculosis. *Clin Infect Dis.* 2017;64(12):1670–1677.
69. Handbook for the use of digital technologies to support tuberculosis medication adherence. Geneva: World Health Organization; 2017 (<https://apps.who.int/iris/handle/10665/259832>, accessed 1 December 2021).
70. WHO guidelines on tuberculosis infection prevention and control, 2019 update. Geneva: World Health Organization; 2019 (<https://apps.who.int/iris/handle/10665/311259>, accessed 1 December 2021).
71. Definitions and reporting framework for tuberculosis: 2013 revision (updated December 2014 and January 2020). Geneva: World Health Organization; 2013 (<https://apps.who.int/iris/handle/10665/79199>, accessed 3 December 2021).
72. The Union’s desk guide for diagnosis and management of TB in children, third edition. Paris: International Union Against Tuberculosis and Lung Disease; 2016 (https://theunion.org/sites/default/files/2020-08/2016_Desk-guide_Africa_Web.pdf, accessed 3 December 2021).
73. Kay AW, Gonzalez Fernandez L, Takwoingi Y, et al. Xpert MTB/RIF and Xpert MTB/RIF Ultra assays for active tuberculosis and rifampicin resistance in children. *Cochrane Database Syst Rev.* 2020;8:CD013359.

74. Jasumback CL, Dlamini Q, Kahari J, et al. Laboratory comparison of stool processing methods for Xpert® Ultra. *Public Health Action*. 2021;11(2):55–57.
75. Zar HJ, Workman L, Isaacs W, et al. Rapid molecular diagnosis of pulmonary tuberculosis in children using nasopharyngeal specimens. *Clin Infect Dis*. 2012;55(8):1088–1095.
76. World Health Organization. WHO operational handbook on tuberculosis. Module 3: diagnosis – rapid diagnostics for tuberculosis detection, 2021 update. Geneva: World Health Organization; 2021 (<https://apps.who.int/iris/handle/10665/342369>, accessed 1 December 2021).
77. Package of care for children and adolescents with advanced HIV disease: stop AIDS. Geneva: World Health Organization; 2020 (<https://apps.who.int/iris/handle/10665/332907>, accessed 6 December 2021).
78. Consolidated guidelines on HIV prevention, testing, treatment, service delivery and monitoring: recommendations for a public health approach. Geneva: World Health Organization; 2021 (<https://apps.who.int/iris/handle/10665/342899>, accessed 1 December 2021).
79. Fry SH, Barnabas SL, Cotton MF. Tuberculosis and HIV: an update on the “cursed duet” in children. *Front Pediatr*. 2019;7:159.
80. Integrated Management of Childhood Illness: chart booklet. Geneva: World Health Organization; 2014 (<https://apps.who.int/iris/handle/10665/104772>, accessed 1 December 2021).
81. Updated guideline: paediatric emergency triage, assessment and treatment – care of critically ill children. Geneva: World Health Organization; 2016 (<https://apps.who.int/iris/handle/10665/204463>, accessed 8 March 2022).
82. WHO operational handbook on tuberculosis. Module 4: treatment – drug-resistant tuberculosis treatment. Geneva: World Health Organization; 2020 (<https://apps.who.int/iris/handle/10665/332398>, accessed 2 December 2021).
83. Chiang SS, Brooks MB, Jenkins HE, et al. Concordance of drug-resistance profiles between persons with drug-resistant tuberculosis and their household contacts: a systematic review and meta-analysis. *Clin Infect Dis*. 2021;73(2):250–263.
84. Management of drug-resistant tuberculosis in children: a field guide. Boston, MA: Sentinel Project for Pediatric Drug-Resistant Tuberculosis; 2019 (http://sentinel-project.org/wp-content/uploads/2019/02/Updated_DRTB-Field-Guide-2019-V3.pdf, accessed 2 December 2021).
85. Jenkins HE, Yuen CM, Rodriguez CA, et al. Mortality in children diagnosed with tuberculosis: a systematic review and meta-analysis. *Lancet Infect Dis*. 2017;17(3):285–295.
86. Turkova A, Wills GA, Wobudeya E, et al. Shorter treatment for nonsevere tuberculosis in African and Indian children. *N Engl J Med*. 2022;386(7).
87. WHO consolidated guidelines on tuberculosis. Module 4: treatment – drug-susceptible tuberculosis treatment. Geneva: World Health Organization; 2022 (<https://www.who.int/publications/i/item/9789240048126>, accessed 8 March 2022).
88. Graham SM, Grzemska M, Gie RP. The background and rationale for a new fixed-dose combination for first-line treatment of tuberculosis in children. *Int J Tuberc Lung Dis*. 2015;19(Suppl 1):3–8.
89. Donald PR, Maher D, Maritz JS, Qazi S. Ethambutol dosage for the treatment of children: literature review and recommendations. *Int J Tuberc Lung Dis*. 2006;10(12):1318–1330.
90. WHO case definitions of HIV for surveillance and revised clinical staging and immunological classification of HIV-related disease in adults and children. Geneva: World Health Organization; 2007 (<https://apps.who.int/iris/handle/10665/43699>, accessed 6 December 2021).
91. Guideline: updates on the management of severe acute malnutrition in infants and children. Geneva: World Health Organization; 2013 (<https://apps.who.int/iris/handle/10665/95584>, accessed 8 March 2022).

92. Schaaf HS, Marais BJ, Whitelaw A, et al. Culture-confirmed childhood tuberculosis in Cape Town, South Africa: a review of 596 cases. *BMC Infect Dis.* 2007;7(1):140.
93. Wolzak NK, Cooke ML, Orth H, van Toorn R. The changing profile of pediatric meningitis at a referral centre in Cape Town, South Africa. *J Trop Pediatr.* 2012;58(6):491–495.
94. Chiang SS, Khan FA, Milstein MB, et al. Treatment outcomes of childhood tuberculous meningitis: a systematic review and meta-analysis. *Lancet Infect Dis.* 2014;14(10):947–957.
95. Van Toorn R, Schaaf HS, Laubscher JA, et al. Short intensified treatment in children with drug-susceptible tuberculous meningitis. *Pediatr Infect Dis J.* 2014;33(3):248–252.
96. Van Well GT, Paes BF, Terwee CB, et al. Twenty years of pediatric tuberculous meningitis: a retrospective cohort study in the western cape of South Africa. *Pediatrics.* 2009;123(1):e1–e8.
97. Rapid advice: treatment of tuberculosis in children. Geneva: World Health Organization; 2010 (<https://apps.who.int/iris/handle/10665/44444>, accessed 8 March 2022).
98. Donald PR. The chemotherapy of tuberculous meningitis in children and adults. *Tuberculosis (Edinb).* 2010;90(6):375–392.
99. Guidelines for the management of tuberculosis in children. Pretoria: Department of Health; 2013 (www.kznhealth.gov.za/family/National-Childhood-TB-Guidelines-2013-ZA.pdf, accessed 11 March 2022).
100. Statement on the use of child-friendly fixed-dose combinations for the treatment of TB in children. Geneva; World Health Organization and United Nations Children’s Fund; 2017 (https://cdn.who.int/media/docs/default-source/documents/tuberculosis/statement-on-the-use-of-child-friendly-fixed-dose-combinations-for-the-treatment-of-tb-in-children8ce21e28-f351-4abe-92de-4b757cf2d0d8.pdf?sfvrsn=82f15c83_1&download=true, accessed 11 March 2022).
101. New pathways for childhood TB treatment: lessons from the STEP-TB Project. New York and Vernier: TB Alliance and Unitaid; 2017 (https://www.tballiance.org/sites/default/files/child-resources/New_Pathways_for_Childhood_TB_Treatment.pdf, accessed 6 December 2021).
102. Prasad K, Singh MB, Ryan H. Corticosteroids for managing tuberculous meningitis. *Cochrane Database Syst Rev.* 2016;4(4):CD002244.
103. Schoeman JF, Van Zyl LE, Laubscher JA, Donald PR. Effect of corticosteroids on intracranial pressure, computed tomographic findings, and clinical outcome in young children with tuberculous meningitis. *Pediatrics.* 1997;99(2):226–231.
104. Essential nutrition actions: mainstreaming nutrition through the life-course. Geneva: World Health Organization; 2019 (<https://apps.who.int/iris/handle/10665/326261>, accessed 8 March 2022).
105. Guideline: nutritional care and support for patients with tuberculosis. Geneva: World Health Organization; 2013 (<https://apps.who.int/iris/handle/10665/94836>, accessed 6 December 2021).
106. Saukkonen JJ, Cohn DL, Jasmer RM, et al. An official ATS statement: hepatotoxicity of antituberculosis therapy. *Am J Respir Crit Care Med.* 2006;174(8):935–952.
107. Guidelines for treatment of drug-susceptible tuberculosis and patient care: 2017 update. Geneva: World Health Organization; 2017 (<https://apps.who.int/iris/handle/10665/255052>, accessed 8 March 2022).
108. Meeting report of the WHO expert consultation on drug-resistant tuberculosis treatment outcome definitions, 17–19 November 2020. Geneva: World Health Organization; 2021 (<https://apps.who.int/iris/handle/10665/340284>, accessed 6 December 2021).
109. Nahid P, Dorman SE, Alipanah N, et al. Official American Thoracic Society/Centers for Disease Control and Prevention/Infectious Diseases Society of America clinical practice guidelines: treatment of drug-susceptible tuberculosis. *Clin Infect Dis.* 2016;63(7):e147–e195.

110. Jenkins HE, Tolman AW, Yuen CM, et al. Incidence of multidrug-resistant tuberculosis disease in children: systematic review and global estimates. *Lancet*. 2014;383(9928):1572–1579.
111. Harausz EP, Garcia-Prats AJ, Law S, et al. Treatment and outcomes in children with multidrug-resistant tuberculosis: a systematic review and individual patient data meta-analysis. *PLoS Med*. 2018;15(7):e1002591.
112. Seddon JA, Hesselning AC, Godfrey-Faussett P, Schaaf HS. High treatment success in children treated for multidrug-resistant tuberculosis: an observational cohort study. *Thorax*. 2014;69(5):458–464.
113. Shah NS, Yuen CM, Heo M, et al. Yield of contact investigations in households of patients with drug-resistant tuberculosis: systematic review and meta-analysis. *Clin Infect Dis*. 2014;58(3):381–391.
114. Ettehad D, Schaaf HS, Seddon JA, et al. Treatment outcomes for children with multidrug-resistant tuberculosis: a systematic review and meta-analysis. *Lancet Infect Dis*. 2012;12(6):449–456.
115. Gegia M, Jenkins HE, Kalandadze I, Furin J. Outcomes of children treated for tuberculosis with second-line medications in Georgia, 2009–2011. *Int J Tuberc Lung Dis*. 2013;17(5):624–629.
116. WHO consolidated guidelines on tuberculosis. Module 4: treatment – drug-resistant tuberculosis treatment. Geneva: World Health Organization; 2020 (<https://apps.who.int/iris/handle/10665/332397>, accessed 2 December 2021).
117. Dooley KE, Rosenkranz SL, Conradie F, et al. QT effects of bedaquiline, delamanid, or both in patients with rifampicin-resistant tuberculosis: a phase 2, open-label, randomised, controlled trial. *Lancet Infect Dis*. 2021;21(7):975–983.
118. Svensson EM, Aweeka F, Park JG, et al. Model-based estimates of the effects of efavirenz on bedaquiline pharmacokinetics and suggested dose adjustments for patients coinfecting with HIV and tuberculosis. *Antimicrob Agents Chemother*. 2013;57(6):2780–2787.
119. Svensson EM, Dooley KE, Karlsson MO. Impact of lopinavir-ritonavir or nevirapine on bedaquiline exposures and potential implications for patients with tuberculosis-HIV coinfection. *Antimicrob Agents Chemother*. 2014;58(11):6406–6412.
120. Brill MJ, Svensson EM, Pandie M, et al. Confirming model-predicted pharmacokinetic interactions between bedaquiline and lopinavir/ritonavir or nevirapine in patients with HIV and drug-resistant tuberculosis. *Int J Antimicrob Agents*. 2017;49(2):212–217.
121. Mallikaarjun S, Wells C, Petersen C, et al. Delamanid coadministered with antiretroviral drugs or antituberculosis drugs shows no clinically relevant drug–drug interactions in healthy subjects. *Antimicrob Agents Chemother*. 2016;60(10):5976–5985.
122. StopTB Partnership Global Drug Facility Paediatric Drug-Resistant TB (DR-TB) Donation Initiative [website]. Boston: Sentinel Project on Pediatric Drug-Resistant Tuberculosis; 2019 (<http://sentinel-project.org/2019/02/18/stoptbgdfs-paediatric-drug-resistant-tb-dr-tb-donation-initiative/>, accessed 16 March 2022).
123. Svensson EM, du Bois J, Kitshoff R, et al. Relative bioavailability of bedaquiline tablets suspended in water: implications for dosing in children. *Br J Clin Pharmacol*. 2018;84(10):2384–2392.
124. Schaaf HS, Thee S, van der Laan L, et al. Adverse effects of oral second-line antituberculosis drugs in children. *Expert Opin Drug Saf*. 2016;15(10):1369–1381.
125. Garcia-Prats AJ, Schaaf HS, Hesselning AC. The safety and tolerability of the second-line injectable antituberculosis drugs in children. *Expert Opin Drug Saf*. 2016;15(11):1491–1500.
126. Schaaf HS, Garcia-Prats AJ, McKenna L, Seddon JA. Challenges of using new and repurposed drugs for the treatment of multidrug-resistant tuberculosis in children. *Expert Rev Clin Pharmacol*. 2018;11(3):233–244.
127. Garcia-Prats AJ, Schaaf HS, Draper HR, et al. Pharmacokinetics, optimal dosing, and safety of linezolid in children with multidrug-resistant tuberculosis: combined data from two prospective observational studies. *PLoS Med*. 2019;16(4):e1002789.

128. Isaakidis P, Paryani R, Khan S, et al. Poor outcomes in a cohort of HIV-infected adolescents undergoing treatment for multidrug-resistant tuberculosis in Mumbai, India. *PLoS One*. 2013;8(7):e68869.
129. Moyo S, Furin JJ, Hughes J, et al. Outcomes in adolescents undergoing treatment for drug-resistant tuberculosis in Cape Town, South Africa, 2008–2013. *Arch Pediatr Infect Dis*. 2015;3(1 TB):e17934.
130. A family-centered approach to the treatment and prevention of drug-resistant tuberculosis in children and adolescents: Counselling tools and approach. Khayelitsha: Medecins Sans Frontieres; 2021 (http://sentinel-project.org/wp-content/uploads/2021/12/Peds_Counseling_Outline_V3.pdf, accessed 12 March 2022).
131. Allwood BW, Byrne A, Meghji J, et al. Post-tuberculosis lung disease: clinical review of an under-recognised global challenge. *Respiration*. 2021;100(8):751–763.
132. Allwood BW, Amaral AFS, Byrne A, et al. Post-tuberculosis lung health: perspectives from the First International Symposium. *Int J Tuberc Lung Dis*. 2020;24(8):820–828.
133. Dodd PJ, Yuen CM, Jayasooriya SM, et al. Quantifying the global number of tuberculosis survivors: a modelling study. *Lancet Infect Dis*. 2021;21(7):984–992.
134. Schoeman J, Wait J, Burger M, et al. Long-term follow up of childhood tuberculous meningitis. *Dev Med Child Neurol*. 2002;44(8):522–526.
135. Gupta R, Kushwaha S, Thakur R, et al. Predictors of adverse outcome in patients of tuberculous meningitis in a multi-centric study from India. *Indian J Tuberc*. 2017;64(4):296–301.
136. Dhawan SR, Gupta A, Singhi P, et al. Predictors of neurological outcome of tuberculous meningitis in childhood: a prospective cohort study from a developing country. *J Child Neurol*. 2016;31(14):1622–1627.
137. Davis AG, Nightingale S, Springer PE, et al. Neurocognitive and functional impairment in adult and paediatric tuberculous meningitis. *Wellcome Open Res*. 2019;4:178.
138. Dian S, Hermawan R, van Laarhoven A, et al. Brain MRI findings in relation to clinical characteristics and outcome of tuberculous meningitis. *PLoS One*. 15(11): e0241974.
139. Garg RK, Malhotra HS, Kumar N, Uniyal R. Vision loss in tuberculous meningitis. *J Neurol Sci*. 2017;375:27–34.
140. Lam KS, Sham MM, Tam SC, et al. Hypopituitarism after tuberculous meningitis in childhood. *Ann Intern Med*. 1993;118(9):701–706.
141. Osman M, Welte A, Dunbar R, et al. Morbidity and mortality up to 5 years post tuberculosis treatment in South Africa: a pilot study. 2019. *Int J Infect Dis*. 2019;85:57–63.
142. Basham CA, Romanowski K, Johnston JC. Life after tuberculosis: planning for health. *Lancet Respir Med*. 2019;7(12):1004–1006.
143. Romanowski K, Baumann B, Basham CA, et al. Long-term all-cause mortality in people treated for tuberculosis: a systematic review and meta-analysis. *Lancet Infect Dis*. 2019;19(10):1129–1137.
144. Marx FM, Cohen T, Menzies NA, et al. Cost-effectiveness of post-treatment follow-up examinations and secondary prevention of tuberculosis in a high-incidence setting: a model-based analysis. *Lancet Glob Health*. 2020;8(9):e1223–e1233.
145. Marx FM, Yaesoubi R, Menzies NA, et al. Tuberculosis control interventions targeted to previously treated people in a high-incidence setting: a modelling study. *Lancet Glob Health*. 2018;6(4):e426–e435.
146. Beydon N, Davis SD, Lombardi E, et al. An official American Thoracic Society/European Respiratory Society statement: pulmonary function testing in preschool children. *Am J Respir Crit Care Med*. 2007;175(12):1304–1345.
147. Guillien A, Soumagne T, Regnard J, Degano B. Les nouvelles équations de référence du Global Lung Function Initiative (GLI) pour les explorations fonctionnelles respiratoires. [The new reference equations of the Global Lung function Initiative (GLI) for pulmonary function tests.] *Rev Mal Respir*. 2018;35(10):1020–1027.

148. Chang AB, Fortescue R, Grimwood K, et al. European Respiratory Society guidelines for the management of children and adolescents with bronchiectasis. *Eur Respir J*. 2021;58(2):2002990.
149. Shah I, Dani S, Shetty NS, et al. Profile of osteoarticular tuberculosis in children. *Indian J Tuberc*. 2020;67(1):43–45.
150. Rajasekaran S. Natural history of Pott’s kyphosis. *Eur Spine J*. 2013;22(Suppl 4):634–640.
151. Mann TN, Schaaf HS, Dunn RN, et al. Child and adult spinal tuberculosis at tertiary hospitals in the Western Cape, South Africa: 4-year burden and trend. *Epidemiol Infect*. 2018;146(16):2107–2115.
152. Dhammi I, Kumar S. Current concepts in diagnosis and management of osteoarticular tuberculosis. *Orthop J M P*. 2020;26(1):3–13.
153. Germain N, Aballéa S, Toumi M. Measuring health-related quality of life in young children: how far have we come? [Published correction appears in *J Mark Access Health Policy*. 2019;11;7(1):1626572.] *J Mark Access Health Policy*. 2019;7(1):1618661.
154. Verstraete J, Ramma L, Jelsma J. Item generation for a proxy health related quality of life measure in very young children. *Health Qual Life Outcomes*. 2020;18(1):11.
155. Wille N, Badia X, Bonsel G, et al. Development of the EQ-5D-Y: a child-friendly version of the EQ-5D. *Qual Life Res*. 2010;19(6):875–886.
156. Verstraete J, Lloyd A, Scott D, Jelsma J. How does the EQ-5D-Y Proxy version 1 perform in 3, 4 and 5-year-old children? *Health Qual Life Outcomes*. 2020;18:149.
157. Graham SM, Sekadde MP. Case detection and diagnosis of tuberculosis in primary-care settings. *Paediatr Int Child Health*. 2019;39(2):84–87.
158. Dongo JP, Graham SM, Nsonga J, et al. Implementation of an effective decentralised programme for detection, treatment and prevention of tuberculosis in children. *Trop Med Infect Dis*. 2021;6(3).
159. Talukder K, Salim MA, Jerin I, et al. Intervention to increase detection of childhood tuberculosis in Bangladesh. *Int J Tuberc Lung Dis*. 2012;16(1):70–75.
160. Ketema L, Dememew ZG, Assefa D, et al. Evaluating the integration of tuberculosis screening and contact investigation in tuberculosis clinics in Ethiopia: a mixed method study. *PLoS One*. 2020;15(11):e0241977.
161. Maha A, Majumdar SS, Main S, et al. The effects of decentralisation of tuberculosis services in the East New Britain Province, Papua New Guinea. *Publ Health Act*. 2019;9(Suppl 1):S43-S49.
162. Multisectoral accountability framework to accelerate progress to end tuberculosis by 2030. Geneva: World Health Organization; 2019 (<https://apps.who.int/iris/handle/10665/331934>, accessed 1 December 2021).
163. WHO Multisectoral Accountability Framework for TB (MAF-TB): baseline assessment checklist for country use in pursuing a national MAF-TB. Geneva: World Health Organization; 2020 (https://www.who.int/docs/default-source/documents/tuberculosis/multisectoral-accountability-framework-tb-tuberculosis-checklist.pdf?sfvrsn=6ba20074_1&download=true, accessed 1 December 2021).
164. Progress towards the achievement of global tuberculosis targets and implementation of the political declaration of the high-level meeting of the General Assembly on the fight against tuberculosis: report of the Secretary-General. New York: United Nations General Assembly; 2020 (<https://apps.who.int/iris/handle/10665/343376>, accessed 8 March 2022).
165. Zawedde-Muyanja S, Nakanwagi A, Dongo JP, et al. Decentralisation of child tuberculosis services increases case finding and uptake of preventive therapy in Uganda. *Int J Tuberc Lung Dis*. 2018;22(11):1314–1321.
166. Khan AJ, Khowaja S, Khan FS, et al. Engaging the private sector to increase tuberculosis case detection: an impact evaluation study. *Lancet Infect Dis*. 2012;12(8):608–616.

167. WHO policy on collaborative TB/HIV activities: guidelines for national programmes and other stakeholders. Geneva: World Health Organization; 2012 (<https://apps.who.int/iris/handle/10665/44789>, accessed 1 December 2021).
168. Standards for improving the quality of care for children and young adolescents in health facilities. Geneva: World Health Organization; 2018 (<https://apps.who.int/iris/handle/10665/272346>, accessed 1 December 2021).
169. Young M, Wolfheim C, Marsh DR, Hammamy D. World Health Organization/United Nations Children's Fund joint statement on integrated community case management: an equity-focused strategy to improve access to essential treatment services for children. *Am J Trop Med Hyg.* 2012;87(5 Suppl):6–10.
170. Marais BJ, Obihara CC, Warren RM, et al. The burden of childhood tuberculosis: a public health perspective. *Int J Tuberc Lung Dis.* 2005;9(12):1305–1313.
171. Onazi O, Gidado M, Onazi M, et al. Estimating the cost of TB and its social impact on TB patients and their households. *Publ Health Act.* 2015;5(2):127–131.
172. Goyal-Honavar A, Markose AP, Chhakchuakk L, et al. Unmasking the human face of TB: the impact of tuberculosis on the families of patients. *J Fam Med Prim Care.* 2020;9(10):5345–5350.
173. Best practices in child and adolescent tuberculosis care. Geneva: World Health Organization; 2018 (<https://apps.who.int/iris/handle/10665/274373>, accessed 1 December 2021).
174. Public–private mix for TB prevention and care: a roadmap. Geneva: World Health Organization; 2018 (<https://apps.who.int/iris/handle/10665/333885>, accessed 1 December 2021).
175. Stallworthy G, Dias HM, Pai M. Quality of tuberculosis care in the private health sector. *J Clin Tuberc Other Mycobact Dis.* 2020;20:100171.
176. Uplekar M, Juvekar S, Morankar S, et al. Tuberculosis patients and practitioners in private clinics in India. *Int J Tuberc Lung Dis.* 1998;2(4):324–329.
177. Integrating intensive TB case finding and TB preventive treatment services into differentiated ART models: framework for implementation. New York: CQUIN TB/HIV Community of Practice; 2019 (https://cquin.icap.columbia.edu/wp-content/uploads/2020/01/CQUIN-TPT-Toolkit_Jan-2020_Final_Cover.pdf, accessed 1 December 2021).
178. Maintaining essential health services: operational guidance for the COVID-19 context. Interim guidance: 1 June 2020. Geneva: World Health Organization; 2020 (<https://apps.who.int/iris/handle/10665/332240>, accessed 3 December 2021).
179. WHO information note: COVID-19 – considerations for tuberculosis (TB) care. Geneva: World Health Organization; 2021 (<https://apps.who.int/iris/handle/10665/341126>, accessed 1 December 2021).
180. Briefing note: testing for both tuberculosis and SARS-CoV-2. Geneva: Global Fund to Fight AIDS, Tuberculosis and Malaria; 2021 (https://www.theglobalfund.org/media/11438/covid19_tb-testing_briefingnote_en.pdf, accessed 3 December 2021).
181. Cerrone M, Wang X, Neary M, et al. Pharmacokinetics of efavirenz 400 mg once daily coadministered with isoniazid and rifampicin in human immunodeficiency virus-infected individuals. *Clin Infect Dis.* 2019;68(3):446–452.
182. Dooley KE, Sayre P, Borland J, et al. Safety, tolerability, and pharmacokinetics of the HIV integrase inhibitor dolutegravir given twice daily with rifampin or once daily with rifabutin: results of a phase 1 study among healthy subjects. *J Acquir Immune Defic Syndr.* 2013;62(1):21–27.
183. Dooley KE, Kaplan R, Mwelase N, et al. Dolutegravir-based antiretroviral therapy for patients coinfecting with tuberculosis and human immunodeficiency virus: a multicenter, noncomparative, open-label, randomized trial. *Clin Infect Dis.* 2020;70(4):549–556.

184. Meintjes G, Rabie H, Wilkinson RJ, Cotton MF. Tuberculosis-associated immune reconstitution inflammatory syndrome and unmasking of tuberculosis by antiretroviral therapy. *Clin Chest Med*. 2009;30(4):797–810.
185. Link-Gelles R, Moultrie H, Sawry S, et al. Tuberculosis immune reconstitution inflammatory syndrome in children initiating antiretroviral therapy for HIV infection: a systematic literature review. *Pediatr Infect Dis J*. 2014;33(5):499–503.
186. Rabie H, Violari A, Duong T, et al. Early antiretroviral treatment reduces risk of bacille Calmette-Guérin immune reconstitution adenitis. *Int J Tuberc Lung Dis*. 2011;15(9):1194-i.
187. Mathad JS, Gupta A. Tuberculosis in pregnant and postpartum women: epidemiology, management, and research gaps. *Clin Infect Dis*. 2012;55(11):1532–1549.
188. Jonsson J, Kuhlmann-Berenzon S, Berggren I, Bruchfeld J. Increased risk of active tuberculosis during pregnancy and postpartum: a register-based cohort study in Sweden. *Eur Respir J*. 2020;55(3).
189. Tuberculosis in women. Geneva: World Health Organization; 2015 (https://www.who.int/tb/challenges/hiv/tb_women_factsheet.pdf, accessed 6 December 2021).
190. Loto OM, Awowole I. Tuberculosis in pregnancy: a review. *J Pregnancy*. 2012;2012:379271.
191. Gupta A, Nayak U, Ram M, et al. Postpartum tuberculosis incidence and mortality among HIV-infected women and their infants in Pune, India, 2002–2005. *Clin Infect Dis*. 2007;45(2):241–249.
192. Gupta A, Bhosale R, Kinikar A, et al. Maternal tuberculosis: a risk factor for mother-to-child transmission of human immunodeficiency virus. *J Infect Dis*. 2011;203(3):358–363.
193. Gomes VF, Andersen A, Wejse C, et al. Impact of tuberculosis exposure at home on mortality in children under 5 years of age in Guinea-Bissau. *Thorax*. 2011;66(2):163–167.
194. Zenner D, Kruijshaar ME, Andrews N, Abubakar I. Risk of tuberculosis in pregnancy: a national, primary care-based cohort and self-controlled case series study. *Am J Respir Crit Care Med*. 2012;185(7):779–784.
195. Sugarman J, Colvin C, Moran AC, Oxlade O. Tuberculosis in pregnancy: an estimate of the global burden of disease. *Lancet Glob Health*. 2014;2(12):e710–e716.
196. Chabala C, Turkova A, Thomason MJ, et al. Shorter treatment for minimal tuberculosis (TB) in children (SHINE): a study protocol for a randomised controlled trial. *Trials*. 2018;19(1):237.
197. Resolution WHA67.19. Strengthening of palliative care as a component of comprehensive care throughout the life course. Geneva: World Health Organization; 2014 (<https://apps.who.int/iris/handle/10665/162863>, accessed 6 December 2021).
198. Global atlas of palliative care, 2nd edition. London: Worldwide Palliative Care Alliance; 2020 (<http://www.thewhpc.org/resources/global-atlas-on-end-of-life-care>, accessed 6 December 2021).
199. Connor SR. Palliative care for tuberculosis. *J Pain Symptom Manage*. 2018;55(2S):S178–S180.
200. Connor S, Foley K, Harding R, Jaramillo E. Declaration on palliative care and MDR/XDR-TB. *Int J Tuberc Lung Dis*. 2012;16(6):712–713.
201. USAID/TB CARE II Project. Comprehensive guidelines for TB and DR-TB palliative care and support. Bethesda, MD: University Research Co., LLC. (<http://www.thewhpc.org/resources/item/south-african-palliative-care-guidelines-for-tb>, accessed 8 March 2022).
202. Clinical practice guidelines for providing palliative care to patients with tuberculosis. Bishkek: Ministry of Health of the Kyrgyz Republic; 2014 ([http://www.thewhpc.org/resources?task=callelement&format=rw&item_id=625&element=f85c494b-2b32-4109-b8c1-083cca2b7db6&method=download&args\[0\]=0f2b19dd0c28b8279b243d317b90f7d4](http://www.thewhpc.org/resources?task=callelement&format=rw&item_id=625&element=f85c494b-2b32-4109-b8c1-083cca2b7db6&method=download&args[0]=0f2b19dd0c28b8279b243d317b90f7d4), accessed 6 December 2021).
203. Integrating palliative care and symptom relief into paediatrics: a WHO guide for health care planners, implementers and managers. Geneva: World Health Organization; 2018 (<https://apps.who.int/iris/handle/10665/274561>, accessed 6 December 2021).

204. Policy brief: palliative care for children with drug-resistant tuberculosis. Bristol: International Children's Palliative Care Network; 2013 (<http://www.riatt-esa.org/s/Policy-Brief-on-Palliative-Care-for-Children-with-Durg-Resistant-TUberculosis-DR-TB.pdf>, accessed 6 December 2021).
205. Palliative care for children with drug-resistant TB: an ICPCN position paper. Bristol: International children's palliative care network; 2013 (<https://www.icpcn.org/wp-content/uploads/2013/07/ICPCN-Position-paper-on-Drug-Resistant-TB.pdf>, accessed 6 December 2021).
206. Assessing the development of palliative care worldwide: a set of actionable indicators. Geneva: World Health Organization; 2021 (<https://apps.who.int/iris/handle/10665/345532>, accessed 6 December 2021).
207. Craig F, Henderson EM, Bluebond-Langner M. Management of respiratory symptoms in paediatric palliative care. *Curr Opin Support Palliat Care*. 2015;9(3):217–226.
208. Ringholz F, Devins M, McNally P. Managing end stage lung disease in children. *Paediatr Respir Rev*. 2014;15(1):75–80.
209. Ross DA, Hinton R, Melles-Brewer M, et al. Adolescent well-being: a definition and conceptual framework. *J Adolesc Health*. 2020;67(4):472–476.
210. Kay AW, Thivalapill N, Skinner D, et al. Predictors of suboptimal adherence to isoniazid preventive therapy among adolescents and children living with HIV. *PLoS One*. 2020;15(12):e0243713.
211. Hovell M, Blumberg E, Gil-Trejo L, et al. Predictors of adherence to treatment for latent tuberculosis infection in high-risk Latino adolescents: a behavioral epidemiological analysis. *Soc Sci Med*. 2003;56(8):1789–1796.
212. Kam A, Ford-Jones L, Malloy P, et al. Active tuberculosis among adolescents in Toronto, Canada: clinical features and delays in diagnosis. *Pediatr Infect Dis J*. 2007;26(4):355–356.
213. Nduba V, Hoog AH, Mitchell E, et al. Prevalence of tuberculosis in adolescents, western Kenya: implications for control programs. *Int J Infect Dis*. 2015;35:11–17.
214. Enane LA, Lowenthal ED, Arscott-Mills T, et al. Loss to follow-up among adolescents with tuberculosis in Gaborone, Botswana. *Int J Tuberc Lung Dis*. 2016;20(10):1320–1325.
215. Mulongeni P, Hermans S, Caldwell J, et al. HIV prevalence and determinants of loss-to-follow-up in adolescents and young adults with tuberculosis in Cape Town. *PloS One*. 2019;14(2):e0210937.
216. Enane LA, Eby J, Arscott-Mills T, et al. TB and TB-HIV care for adolescents and young adults. *Int J Tuberc Lung Dis*. 2020;24(2):240–249.
217. Guix-Comellas E-M, Rozas L, Velasco-Arnaiz E, et al. Adherence to antituberculosis drugs in children and adolescents in a low-endemic setting: a retrospective series. *Pediatr Infect Dis J*. 2017;36(6):616–618.
218. De Oliveira MCB, Sant'Anna CC, Raggio Luiz R, Kritski AL. Unfavorable outcomes in tuberculosis: multidimensional factors among adolescents in Rio de Janeiro, Brazil. *Am J Trop Med Hyg*. 2020;103(6):2492–2500.
219. Reif LK, Rivera V, Bertrand R, et al. Outcomes across the tuberculosis care continuum among adolescents in Haiti. *Publ Health Act*. 2018;8(3):103–109.
220. Laycock KM, Eby J, Arscott-Mills T, et al. Towards quality adolescent-friendly services in TB care. *Int J Tuberc Lung Dis*. 2021;25(7):579–583.
221. Making health services adolescent friendly: developing national quality standards for adolescent friendly health services. Geneva: World Health Organization; 2012 (<https://apps.who.int/iris/handle/10665/75217>, accessed 6 December 2021).
222. Global Accelerated Action for the Health of Adolescents (AA-HA!): guidance to support country implementation – summary. Geneva: World Health Organization; 2017 (<https://apps.who.int/iris/handle/10665/255418>, accessed 6 December 2021).

223. Kazi S, Corcoran H, Abo Y-N, for the ARI Review group. A systematic review of clinical, epidemiological and demographic predictors of tuberculosis in children with pneumonia. *J Glob Health* (in press). 2022.
224. O'Brien KL, Baggett HC, Brooks WA, et al. Causes of severe pneumonia requiring hospital admission in children without HIV infection from Africa and Asia: the PERCH multi-country case-control study. *Lancet*. 2019;394(10200):757–779.
225. Vessière A, Font H, Gabillard D, et al. Impact of systematic early tuberculosis detection using Xpert MTB/RIF Ultra in children with severe pneumonia in high tuberculosis burden countries (TB-Speed pneumonia): a stepped wedge cluster randomized trial. *BMC Pediatrics*. 2021;21(1):136.
226. Marcy O, Font H, Vessière A, for the TB Speed Pneumonia Study Group. Impact of systematic TB detection using Xpert Ultra on nasopharyngeal aspirates and stool samples on mortality in children with severe pneumonia. Presentation. Paris: International Union Against Tuberculosis and Lung Disease; 2021.
227. Results of an international cluster randomized trial on systematic tuberculosis detection in children with severe pneumonia. Bordeaux: TB-SPEED Pneumonia; 2021 (https://www.tb-speed.com/wp-content/uploads/2021/10/TB-Speed_Pneumonia_Study_Press_Release_20211021-.pdf, accessed 8 March 2022).
228. Black RE, Victora CG, Walker SP, et al. Maternal and child undernutrition and overweight in low-income and middle-income countries. *Lancet*. 2013;382(9890):427–451.
229. Patel LN, Detjen AK. Integration of childhood TB into guidelines for the management of acute malnutrition in high burden countries. *Public Health Action*. 2017;7(2):110–115.
230. Jaganath D, Mupere E. Childhood tuberculosis and malnutrition. *J Infect Dis*. 2012;206(12):1809–1815.

Annex 1. Selected resources on child and adolescent TB

Roadmap

Roadmap towards ending TB in children and adolescents, second edition. Geneva: World Health Organization; 2018 (<https://apps.who.int/iris/bitstream/handle/10665/275422/9789241514798-eng.pdf?sequence=1&isAllowed=y>).

WHO operational handbooks

WHO operational handbook on tuberculosis. Module 1: prevention – tuberculosis preventive treatment. Geneva: World Health Organization; 2020 (<https://www.who.int/publications/i/item/9789240002906>).

WHO operational handbook on tuberculosis. Module 2: screening – systematic screening for tuberculosis disease. Geneva: World Health Organization; 2021 (<https://apps.who.int/iris/rest/bitstreams/1336777/retrieve>).

WHO operational handbook on tuberculosis. Module 3: diagnosis – rapid diagnostics for tuberculosis detection, 2021 update. Geneva: World Health Organization; 2021 (<https://apps.who.int/iris/rest/bitstreams/1354562/retrieve>).

WHO operational handbook on tuberculosis. Module 4: treatment – drug-resistant tuberculosis treatment. Geneva: World Health Organization; 2020 (<https://apps.who.int/iris/rest/bitstreams/1281012/retrieve>).

WHO operational handbook on tuberculosis. Module 4: treatment – drug-susceptible tuberculosis treatment. Geneva: World Health Organization; 2022.

WHO operational handbook on tuberculosis. Module 4: treatment – care and support during tuberculosis treatment. Geneva: World Health Organization; 2022.

Prevention

Prevent TB digital platform. Geneva: World Health Organization (<https://www.who.int/activities/preventing-tb#app>).

TB preventive treatment (TPT) implementation tools. Washington, DC: PEPFAR Solutions Platform (<https://www.pepfarsolutions.org/resourcesandtools-2/2018/9/25/tpt-implementation-tools>). (Tool 17b covers considerations for incorporating TPT into differentiated service delivery models – child and adolescent populations.)

Resources. The PEARL study (<https://www.thepearlstudy.org/resources>). (An implementation study using population-wide active case-finding and prevention for TB and leprosy elimination in Kiribati.)

Diagnostic approaches

Making the best out of available tools and approaches: summary guidance for microbiological and clinical diagnosis of pulmonary tuberculosis among children. Geneva: Pediatric TB Operational and Sustainability Expertise Exchange (POSEE) Taskforce; 2021 (https://stoptb.org/wg/dots_expansion/childhoodtb/assets/documents/POSEE%20Info%20Note_Pediatric%20TB%20diagnosis_Final_17.6.2021.pdf).

Practical manual of processing stool samples for diagnosis of childhood TB. Geneva: Global Laboratory Initiative (<https://www.who.int/publications/i/item/9789240042650>).

The SOS Stoolbox: an implementation package for the SOS Stool method to detect TB and rifampicin resistance. The Hague: KNCV (<https://www.kncvtbc.org/en/sos-stoolbox/>).

TB-Speed stool processing: instructions for use – sucrose flotation method. TB-Speed (https://www.tb-speed.com/wp-content/uploads/2020/09/TB-Speed_Stools_Standard_Operating_Procedures.pdf).

TB-Speed nasopharyngeal aspirate (NPA) collection. TB-Speed (https://www.tb-speed.com/wp-content/uploads/2020/09/TB-Speed_SOP_NPA.pdf).

Diagnostic CXR atlas for paediatric pulmonary tuberculosis: a guide to chest X-ray interpretation to diagnose paediatric tuberculosis, second edition. Paris: International Union Against Tuberculosis and Lung Disease; 2022 (<https://theunion.org/technical-publications/diagnostic-cxr-atlas-for-tuberculosis-in-children>).

TB treatment in children and adolescents

Resources, including webinars, project publications and treatment guidelines (website). Boston, MA: Sentinel Project on Pediatric Drug-resistant Tuberculosis (<http://sentinel-project.org/resources/>).

A family-centered approach to the treatment and prevention of drug-resistant tuberculosis in children and adolescents: counseling tools and approach. Khayelitsha, South Africa: Médecins Sans Frontières; 2021 (http://sentinel-project.org/wp-content/uploads/2021/12/Peds_Counseling_Outline_V3.pdf).

Training materials

Child and adolescent TB training for healthcare workers. Paris: International Union Against TB and Lung Disease; 2021 (<https://coursesonline.theunion.org/theunion/2021/child-and-adolescent-tb-training-course-for-hcw/333811>). (This course is also available in French – see below.)

Formation sur la TB chez l'enfant et l'adolescent pour les professionnels de santé. Paris: International Union Against TB and Lung Disease; 2021 (<https://coursesonline.theunion.org/theunion/2021/tb-chez-lenfant-et-ladolescent/337400/faculty.presenter28s29.formation.sur.la.tb.chez.l.enfant.et.l.adolescent.pour.html>). (This course is also available in English – see above.)

TB-Speed 1.5 day chest X-ray training to diagnose childhood tuberculosis: Summary booklet, Child CXR interpretation course: TB-Speed (https://www.tb-speed.com/wp-content/uploads/2021/09/Chest_X-Ray_Training_Children_Tuberculosis_TB-Speed.pdf).

Planning and programme management

Costing of dedicated key interventions towards ending TB in children: development of training materials and implementation of a nationwide training programme for paediatric TB; Household contact investigation; TB preventive treatment; Sample collection for children. Geneva: Pediatric TB

Operational and Sustainability Expertise Exchange (POSEE) Taskforce; 2020 (https://stoptb.org/wg/dots_expansion/childhoodtb/posee.asp).

KNCV benchmarking tool for childhood TB policies, practice and planning. The Hague: KNCV Tuberculosis Foundation (<https://www.kncvtbc.org/en/kb/kncv-benchmarking-tool-for-childhood-tb-policies-practice-and-planning/>).

Advocacy

Change the game: an agenda for action on childhood tuberculosis. New York: United Nations Children's Fund; 2018 (https://data.unicef.org/wp-content/uploads/2018/03/TB-Advocacy-Brochure-Final-3_21-high-Res.pdf).

Tuberculosis research funding trends, 2005–2020. New York: Treatment Action Group; 2021 (https://www.treatmentactiongroup.org/wp-content/uploads/2021/12/tb_funding_2021.pdf).

Pipeline report 2021: tuberculosis diagnostics. New York: Treatment Action Group; 2021 (https://www.treatmentactiongroup.org/wp-content/uploads/2021/11/pipeline_TB_diagnostics_2021_final.pdf).

Pipeline report 2021: tuberculosis preventive treatment. New York: Treatment Action Group; 2021 (https://www.treatmentactiongroup.org/wp-content/uploads/2021/10/2021_pipeline_TB_prev_treatment_final.pdf).

Pipeline report 2021: tuberculosis treatment. New York: Treatment Action Group; 2021 (https://www.treatmentactiongroup.org/wp-content/uploads/2021/11/pipeline_TB_Treatment_2021_final.pdf).

General resources on child and adolescent TB

Graham S, Marais B, Amanullah F, editors. Recent advances and ongoing challenges in the management of tuberculosis in children and adolescents. Special Issue of Pathogens; 2022 (https://www.mdpi.com/journal/pathogens/special_issues/Tuberculosis_Children_Adolescents).

Websites

Ending TB in children and adolescents. Geneva: World Health Organization (<https://www.who.int/activities/ending-tb-in-children-and-adolescents>).

Stop TB Partnership Child and Adolescent Working Group. Geneva: Stop TB Partnership (https://stoptb.org/wg/dots_expansion/childhoodtb/default.asp).

CaP TB: implementation and integration of TB care and treatment models. Washington, DC: Elizabeth Glaser Pediatric AIDS Foundation (<https://www.pedaids.org/resource/catalyzing-pediatric-tuberculosis-innovations-cap-tb-implementation-integration-new-tb-care-treatment-models/>).

A research project to strengthen paediatric tuberculosis services for enhanced early detection. TB-Speed (<https://www.tb-speed.com/>).

Benefit Kids. Better Evidence and Formulations for Improved MDR-TB Treatment for Children (<https://blogs.sun.ac.za/dttc/benefit-kids/>).

Annex 2. Tuberculin skin testing: administration, reading and interpretation

This annex provides information on administering, reading and interpreting tuberculin skin tests (TSTs).

A TST is the intradermal injection of a combination of mycobacterial antigens that elicit a delayed-type hypersensitivity immune response, represented by induration, which can be measured in millimetres.

The standard method of identifying people infected with *Mycobacterium tuberculosis* is the TST using the Mantoux method. Multiple puncture tests should not be used as these tests are unreliable (because the amount of tuberculin injected intradermally cannot be precisely controlled). This annex describes the procedure for a TST using 5 tuberculin units (TU) of tuberculin purified protein derivative (PPD)-S. (Alternatively, 2 TU of tuberculin PPD RT 23 can be used).

Administration

1 Locate and clean the injection site 5–10 cm below the elbow joint:

- Place the forearm palm-up on a firm, well-lit surface.
- Select a smooth area of skin (e.g. free from scars, sores and veins) for placing the TST.
- Clean the area with an alcohol swab.

2 Prepare the syringe:

- Tuberculin vials are multidose vials (of 10 or 50 doses). The vials should be stored at 2–8 °C without exposure to direct sunlight. The vial can be used up to 1 month after opening. It should be discarded if the fluid changes colour or after 30 days.
- Check the expiry date on the vial and ensure the vial contains tuberculin PPD-S (5 TU/0.1 mL) or PPD RT 23 (2 TU/0.1 mL).
- Use a 1 mL graduated syringe or tuberculin syringe that can dispense 0.1 mL solution accurately using a short (8–13 mm) 27-gauge needle.
- Clean the top of the vial with a sterile swab.
- Draw 0.1 mL (5 TU) of tuberculin, or as per the manufacturer's instructions, and expel air and excess drops.
- Tuberculin should be injected within 20 minutes of loading to the syringe.

3 Inject tuberculin:

- After gentle cleaning of the site with an alcohol swab, stretch the selected area of the skin using the thumb and forefinger, insert the needle slowly with the bevel pointing upwards at an angle of 5–15 degrees, and advance the needle through the epidermis approximately 3 mm so the entire bevel is covered and visible just under the skin. Release the stretched skin and slowly inject tuberculin and check for leakage. If there is no leakage, continue to inject slowly until the complete 0.1 mL solution has been administered, and then remove the needle quickly.

- If a drop of blood appears, gently blot the injection site with alcohol-based disinfectant without squeezing out tuberculin.

4 Check injection site:

- When the correct injection technique is used, a pale wheal measuring 6–10 mm in diameter will result. If the wheal is less than 6 mm in diameter, the test should be repeated at a site at least 5 cm away from the original site.

Reading

- The test should be read 48–72 hours after the injection (not before 48 hours or after 72 hours).
- Reading should be performed in good light, with the forearm slightly flexed at the elbow. The reader should gauge the presence of induration (palpable, raised, hardened area or swelling), starting with inspection and then palpation with light, gentle motion. Sweep fingertips over the surface of forearm in all four directions to locate margins or edges of induration. Using the fingertip as a guide, lightly mark the widest edges of the induration across the forearm with a fine line or dot. If the margins of the induration are irregular, mark and measure the widest diameter.
- The diameter of induration is measured across the forearm, from the thumb side of the arm to the little finger side. Using a plastic scale or ruler, place the zero ruler line inside the edge of marked fine line or dot and measure the ruler line inside the right dot or the alternate edge of the fine line. If the measurement falls between two divisions on the millimetre scale, record the lower division.
- Do not measure the diameter of the redness, swelling or bruising. Measure the induration.
- Alternatively, use the ballpoint pen method for reading. A ballpoint pen line may be drawn on the transverse axis of the forearm, starting 1–2 cm away from the visible skin test reaction and moving slowly towards its centre, exerting moderate pressure against the skin. The point where resistance to pen displacement occurs determines the outer limit of the induration. Mark lightly with a fine line or dot at the widest edges of the induration across the forearm and use a ruler to measure the diameter as above.

Recording

- Note the location of TST administration (right or left forearm).
- If there is no induration, record as “zero”. Otherwise, record the exact size of the induration in millimetres. Do not record as positive or negative.
- Record adverse events (if any) at the test site, such as formation of vesicles, bullae, lymphangitis, ulceration or necrosis.

Interpretation

TST does not measure immunity to TB but measures the degree of hypersensitivity to tuberculin. A skin test result is interpreted considering the person’s risk of being infected with TB and progression to disease when infected as well as size of the induration in millimetres. There is no correlation between the size of induration and likelihood of current TB disease (poor positive predictive value) or future risk of developing TB disease. There is no correlation between the size of TST reactions post-BCG vaccination and protection against TB disease. Overall, results of TST must be interpreted carefully considering individual clinical risk factors before determining the size of the induration that is positive (e.g. 5 mm, 10 mm or 15 mm). Details on interpretation are provided in [Chapter 3](#).

Formation of vesicles, bullae, lymphangitis, ulceration and necrosis at the test site should be noted as they may indicate a high degree of tuberculin sensitivity and hence the presence of TB infection.

A negative test may indicate lack of infection with *M. tuberculosis* or that the person has acquired infection recently and not enough time has elapsed for the body to react to the skin test. From the time of infection to the development of cell-mediated immunity, there is a window period of up to 12 weeks when TST would be negative. Most children with a negative result may not be infected with *M. tuberculosis*. Immunologically compromised individuals, especially people living with HIV and low CD4 T-cell counts or severe malnutrition, frequently show negative results from the PPD test. The absence of cell-mediated immunity to tuberculin may be due to lack of previous sensitization or due to anergy because of immune suppression.

Induration of diameter $\geq 5\text{mm}$ is considered positive in:

- children living with HIV;
- severely malnourished children (with clinical evidence of marasmus or kwashiorkor).

Induration of diameter $\geq 10\text{ mm}$ is considered positive in:

- all other children (whether or not they have received BCG vaccination).

Causes of false-negative and false-positive TST are listed in [Table A2.1](#).

Table A2.1. Causes of false-negative and false-positive tuberculin skin tests

False-negative	False-positive
Incorrect administration or interpretation of test	Incorrect interpretation of reaction
HIV	Previous BCG vaccination
Recent TB infection (within 8–10 weeks of exposure)	Infection with non-tuberculosis mycobacteria
Severe forms of TB (e.g. disseminated TB, TB meningitis)	Incorrect method of TST administration
Viral infections (e.g. measles, varicella, Epstein–Barr virus)	Incorrect bottle of antigen used
Vaccinated with live viral vaccines (within 6 weeks)	
Malnutrition	
Bacterial infection (e.g. typhoid, leprosy, pertussis)	
Immunosuppressive medicines (e.g. corticosteroids)	
Neonates and infants aged <6 months	
Primary immunodeficiencies	
Diseases of lymphoid tissue (e.g. Hodgkin disease, lymphoma, leukaemia, sarcoidosis)	
Low protein states	
Improper storage of tuberculin	

Source: adapted from Guidance for national tuberculosis programmes on the management of tuberculosis in children, second edition. Geneva: World Health Organization; 2014; WHO operational handbook on tuberculosis. Module 1: prevention – tuberculosis preventive treatment. Geneva: World Health Organization; 2020 (<https://www.who.int/publications/i/item/9789240002906>); and <https://www.cdc.gov/tb/publications/factsheets/testing/skintesting.htm>.

Annex 3. Sample collection methods

This annex provides an overview of respiratory and non-respiratory specimens that can be used to diagnose TB in children and adolescents, with a short description for each, the age group in which they can be used, the minimum volume required for testing, and the optimal time of collection.

Table A3.1. Respiratory specimens

Specimen	Description of procedure	Age group	Minimum volume for testing ^a	Optimal collection time	Comments
(Spontaneous) expectorated sputum	Expectoration of sputum without prior saline nebulization	>5 years	3 mL	Early morning	If child is unable to produce sputum of sufficient quantity and quality, consider sputum induction
Induced sputum	Expectoration of sputum preceded by hypertonic saline nebulization	Any age	3 mL	Early morning	If child is unable to expectorate (children aged <5 years), consider nasopharyngeal aspiration
Gastric aspirate	Nasogastric aspiration of gastric juice containing swallowed sputum	<7 years	5 mL	Early morning before child gets out of bed	Upon awakening, sitting and standing, peristalsis begins and stomach gradually empties, compromising volume
Gastric lavage	Nasogastric instillation of solution to “wash off” and recover sputum adhered to stomach wall	<7 years	10 mL	Early morning	Recommended only when 3 mL gastric aspirate cannot be obtained

Specimen	Description of procedure	Age group	Minimum volume for testing ^a	Optimal collection time	Comments
Nasopharyngeal aspirate	Nasopharyngeal suctioning of nasopharynx to collect secretions from upper respiratory tract, but may also collect secretions from lower respiratory tract if cough reflex is stimulated	Mostly <7 years	2 mL	Unknown, but probably higher yield in morning	Bacteriological yield of nasopharyngeal aspirate tends to be similar to or lower than that of induced sputum or gastric aspirate/lavage, and this may be a good alternative to these more invasive methods of obtaining sputum
Stool ^b	Sampling of random stool uncontaminated by urine or toilet bowl	Any age	5 g (about 1 tablespoon)	Any time	Xpert (MTB/RIF or Ultra) testing on stool after simple decontamination procedures can have diagnostic yield similar to gastric aspirate and expectorated sputum, while being non-invasive Bacteriological yield of stool for smear and culture is lower than that of sputum and gastric aspirate/lavage
Bronchoalveolar lavage	Bronchoscopy	Any age	3 mL	Any time	Bacteriological yield of one bronchoalveolar lavage sample is not superior to that of serial induced sputum or gastric aspirate/lavage

^a These values are the minimum recommended amount; larger volumes have higher bacteriological yields.

^b Children with TB swallow sputum containing TB bacilli originating from the lungs, which then pass through the digestive tract, where they can be detected in stool samples. Stool is, therefore, regarded as a respiratory specimen for the diagnosis of TB.

Table A3.2. Non-respiratory specimens

Specimen	Description of procedure	Age group	Minimum volume for testing ^a	Optimal collection time	Comments
Cerebrospinal fluid (CSF)	Lumbar puncture	Any age	2 mL	Any time	If requesting culture, submit third or fourth tube of CSF to reduce possibility of contamination due to skin flora
Serosal fluids and tissues ^b	Serosal fluid aspirate with serosal tissue biopsy (if indicated)	Any age	1 mL	Any time	Bacteriological yield of tissue is significantly higher than that of fluid; biochemical markers are useful in all fluids
Urine	Clean-catch, midstream urine	Any age	2 mL	First micturition of morning	Bacteriological yield is low except in urinary tract TB Detection of lipoarabinomannan (LAM) antigen has high sensitivity in children and adolescents living with HIV who are severely immunocompromised
Blood	Phlebotomy	Any age	5 mL	Any time	Bacteriological yield very low; use for mWRD in severely ill people living with HIV with presumed disseminated TB
Fine-needle aspiration biopsy	Fine-needle aspiration biopsy, depending on type of tissue and clinical situation	Any age	Based on type	Any time	Histopathology features (biopsy) consistent with TB can be diagnostic
Bone marrow	Bone marrow aspirate	Any age	1 mL	Any time	Consider bone marrow aspiration in children with presumed disseminated disease Consider testing for other pathogens, especially in children and adolescents living with HIV

mWRD: molecular WHO-recommended rapid diagnostic test.

^a These values are the minimum recommended amount; larger volumes have higher bacteriological yields.

^b Serosal fluids include pleural, pericardial, peritoneal and synovial fluids.

Source: adapted from Management of drug-resistant tuberculosis in children: a field guide, 4th edition. Boston, MA: Sentinel Project for Pediatric Drug-resistant Tuberculosis; 2019.

Annex 4. Standard operating procedures for sample collection methods

This annex provides examples of standard operating procedures for the most common methods of obtaining clinical samples from children for rapid molecular testing: expectoration, gastric aspiration, nasopharyngeal aspiration (NPA) and sputum induction.

Biosafety and infection prevention and control practices to be followed during cough-inducing and aerosol-generating procedures

Gastric aspiration, NPA and sputum induction are considered aerosol-generating procedures. Although children with TB disease are usually less likely than adults to be infectious, transmission from young children can occur.

The following biosafety considerations are required when performing one of these procedures on a child presenting with predictors of infectiousness (including those with extensive pulmonary or laryngeal involvement, e.g. coughing for more than 3 weeks, cavitory TB disease):

- If the child is considered infectious, these procedures should be performed in a dedicated cough room with directional airflow with 6–12 air exchanges per hour.
- All personnel involved must use personal protective equipment (particulate respirators such as N95 or FFP2 masks, eye protection glasses, gloves and a plastic apron). Caregivers assisting personnel with the procedure (e.g. holding a child during specimen collection) should be provided with particulate respirators.
- Put up a sign outside the room indicating that specimen collection is taking place inside, to avoid anyone entering the room during the procedure.
- Wash hands as per the local handwashing protocol before and after the procedure. All surfaces must be cleaned with 70% alcohol solution before and after each procedure.
- After collection, specimen containers should be closed tightly. The outside of the container should be disinfected before it is labelled. The sample should then be placed in a sample bag.
- After the procedure, masks, gloves and disposable aprons should be discarded in a plastic bag or appropriate bin, and hands should be disinfected immediately.
- Allow at least 10 minutes after specimen collection before exiting the room. Close the door immediately. Clearly indicate the time when the next procedure can be done.

Expectoration³⁰

Background

All sputum specimens produced by children and adolescents should be sent for an mWRD. Children and adolescents who can produce a sputum specimen may be able to transmit the disease. They should be asked to produce the specimen outside and not in an enclosed space (e.g. a bathroom) unless there is a room especially equipped for sputum collection.

Procedure

- Reassure the child or adolescent by explaining to them and their family the reason for sputum collection and the procedure.
- Ask the child or adolescent to rinse their mouth with water before producing the specimen. This will help to remove food and any contaminating bacteria in the mouth.
- Ask the child or adolescent to take two deep breaths, holding the breath for a few seconds after each inhalation and then exhaling slowly. Ask the child or adolescent to breathe in a third time and then forcefully blow the air out. Ask them to breathe in again and then cough. This should produce sputum from deep in the lungs. Ask the child or adolescent to hold the sputum container close to the lips and to spit into it gently after a productive cough.
- If the amount of sputum is insufficient, encourage the child or adolescent to cough again until a satisfactory specimen is obtained. Many people cannot produce sputum from deep in the respiratory tract in only a few minutes. Give the child or adolescent sufficient time to produce an expectoration that they feel is produced by a deep cough.
- If there is no expectoration, treat the container as used and dispose of it in the appropriate manner.

Gastric aspiration³¹

Background

Children with TB may swallow mucus that contains *M. tuberculosis*. Gastric aspiration is a technique used to collect gastric contents to try to confirm the diagnosis of TB by rapid molecular tests (or mycobacterial culture if rapid tests are not available). Gastric aspirates are used for collection of samples for diagnostic testing in young children when sputum cannot be spontaneously expectorated or induced using hypertonic saline. It is most useful for young children who are hospitalized. Gastric aspirates are collected from young children with presumed pulmonary TB (PTB). During sleep, the mucociliary system of the lung beats mucus up into the throat. The mucus is swallowed and remains in the stomach until the stomach empties. The highest-yield specimens are therefore obtained first thing in the morning.

³⁰ Adapted from *Guidance for national tuberculosis programmes on the management of tuberculosis in children*, second edition. Geneva: World Health Organization; 2014.

³¹ Adapted from *Guidance for national tuberculosis programmes on the management of tuberculosis in children*, second edition. Geneva: World Health Organization; 2014; and Standard operating procedures: collection, transport and processing of gastric aspirates. CaP-TB project.

Materials needed

- non-sterile gloves;
- particulate respirator masks (N95 or equivalent);
- disposable apron;
- eye protection glasses;
- nasogastric tubes (6–10 French), preferably Ryles or Levin tubes;
- 5, 10 and 20 mL syringes;
- sterile specimen container with screw top (Falcon tube);
- litmus paper/pH strips;
- sodium bicarbonate 4% solution for bedside neutralization;
- three bedsheets or surgical drapes (one for the bed, one to wrap child, one to cover child);
- dropper or small syringe;
- normal saline (0.9% NaCl) or sterile water in single-use vials;
- local anaesthetic gel;
- optional oxymetazoline (to prevent epistaxis);
- alcohol or chlorhexidine;
- laboratory request form;
- permanent marker or pen;
- antiseptic soap.

Contraindications

- child not fasted for 4 hours (3 hours for infants);
- low platelet count or bleeding tendency;
- obstructive lesions in nasopharyngeal tract.

Procedure

- This procedure is routinely performed by nursing personnel.
- The child's parent or guardian should be instructed regarding overnight fasting of at least 4 hours before early-morning gastric aspirate. The procedure is preferably performed early in the morning. It may also be performed during the daytime, as long as the child has fasted for a minimum of 4 hours.
- Use an assistant (e.g. caregiver) to help.
- Prepare all equipment before starting the procedure.
- Disinfect all working surfaces, including the bed. Place a drape over the bed. Use a drape to secure the child and another drape to cover the child, leaving their head exposed.
- Position the child on their back or side with the help of an assistant.
- Optional: instil 2 drops of oxymetazoline into each nostril to induce vasoconstriction and prevent epistaxis.
- Measure the distance of the nasogastric tube between the child's nose and stomach to estimate how far the tube will need to be inserted to reach the stomach.
- Coat the outside of the nasogastric tube with local anaesthetic gel, without covering the holes.
- Place the child's face in the "sniffing air" position, and then pass the nasogastric tube from the nose into the stomach to aspirate gastric contents.
- Attach a syringe (10 mL if using Levin tube or 20mL if using Ryles tube) to the nasogastric tube (size 6–10 French, depending on the size of the child).
- Withdraw (aspirate) gastric contents using the syringe attached to the nasogastric tube.
- To check the position of the tube is correct, test the gastric contents with litmus paper: blue litmus turns red in response to acidic stomach contents. (This can also be checked by pushing 3–5 mL air from the syringe into the stomach and listening with a stethoscope over the stomach.)
- Aspirate stomach contents gently and steadily, with the child in each of three positions: head central, left lateral and right lateral. Allow a few seconds before aspirating after changing position. If no fluid is aspirated, push the tube 1–2 cm deeper or pull it out 1–2 cm, and then aspirate. Ideally 5 mL should be collected (especially in a sick child), but any volume of more than 1 mL is adequate for bacteriological testing.
- If less than 1 mL is aspirated, a gastric lavage can be performed:

- Insert 10 mL of sterile water or preservative-free normal saline in the nasogastric tube, leave for 3 minutes, and then aspirate until a minimum of 5–10 mL aspirate is obtained.
- If no fluid is aspirated, insert an additional 10 mL of sterile water and aspirate again. If still unsuccessful, repeat this up to three times.
- Transfer the full volume of gastric fluid from the syringe into a sterile container (Falcon tube).
- Titrate 4% sodium bicarbonate using a pipette or syringe and pH strips, adding 0.3 mL aliquots to the specimen until pH 6–7 is reached. (This neutralizes the acidic gastric contents and prevents destruction of TB bacilli.) Check pH after each addition of bicarbonate using litmus paper.

After the procedure

- Clean the Falcon tube with alcohol swabs.
- Label the sample: sample type and number, date, time, time of neutralization, volume of bicarbonate added, and total sample volume.
- Complete the laboratory request forms.
- Transport the specimen in a cool box to the laboratory for processing as soon as possible (within 4 hours).
- If it is likely to take more than 4 hours for the specimens to be transported, place them in the refrigerator (at 4–8 °C) and store until transported.
- Give the child their usual food.

Nasopharyngeal aspiration (NPA)³²

Materials needed

- non-sterile gloves;
- particulate respirator masks (N95 or equivalent);
- disposable apron;
- eye protection glasses;
- suction machine (mucus aspirator);
- sterile nasogastric catheter (6–10 French) or mucus extractor (6–8 G);
- normal saline (0.9% NaCl) or sterile water in single-use vials;
- one or two bedsheets to wrap the child;
- optional oxymetazoline (to prevent epistaxis);
- cotton wool;
- alcohol or chlorhexidine;
- sterile sample container (Falcon tubes);
- laboratory request form;
- permanent marker or pen;
- antiseptic soap.

Contraindications

- child not fasted for 2 hours;
- low platelet count or bleeding tendency;
- obstructive lesions in nasopharyngeal tract.

Procedure

- Clearly explain to the child and their family the reason for collecting nasopharyngeal aspirate and the main steps of the procedure.
- Place the child in a supine position on their back or side, or sitting on a family member or caregiver's lap.
- To avoid injury to the child due to movement, young children should be wrapped in a piece of cloth, and an assistant nurse asked to hold the child's head throughout the procedure.

³² Adapted from *Standard operating procedures: collection, transport and processing of nasopharyngeal aspirates*. CaP-TB project; and *TB-Speed standard operating procedure nasopharyngeal aspirate (NPA) collection*, TBS_2P_SOP_BSC, version 1.0, 14/02/2019.

- Clean the child's nose with saline drops and cotton wool. If the child is old enough, ask them to blow their nose into a tissue. If the nasal mucus is too thick to be removed with the measures above, it can be suctioned before NPA. A soft catheter size F6/7 should be used for suctioning and then discarded immediately afterwards.
- Connect the mucus extractor (sputum trap) to the suction pump and the catheter. Do not connect the mucus extractor directly to the suction machine.
- One drop of oxymetazoline may be instilled into each nostril to prevent epistaxis.
- Instil two drops of sterile saline into each nostril.
- Measure the distance from the nostril to the external opening of the ear to find the length of catheter used to aspirate the NPA sample.
- Choose the size of the catheter and adjust the pressure depending on the age of the child:
- Without applying suction, insert the tube through the child's nostril, along the posterior pharyngeal wall until the marked length is reached. If the child does not have teeth, the tube can be introduced via the mouth. Proceed with caution to avoid causing trauma. Usually, the tube makes the child cough and produce sputum, which can then be aspirated.
- Suctioning is activated only when the tip of the catheter is in the posterior nasopharynx.
- Using a rotating movement, collect respiratory secretions by slowly pulling out the tube. Do not push the tube forward while aspirating, as this increases the risk of local trauma.
- The catheter should remain in the nasopharynx for a minimal period of time, and no more than 10 seconds.
- The procedure should aspirate 2–5 mL of secretions. If this volume is not reached with the first aspiration, the procedure should be repeated with nasopharyngeal lavage by inserting 5 mL of normal saline into the same or other nostril.
- The procedure must not be attempted more than three times.
- Stop the procedure immediately if:
 - respiratory distress occurs;
 - profuse sweating, nausea, vomiting, light-headedness, dizziness or loss of consciousness occurs.

Age of child	Size of Catheter	Pressure of suction pump
1–12 months	6 Fr	80–100 mmHg (0.10 bar)
1–10 years	8 Fr	100–120 mmHg (0.15 bar)
>10 years	10 Fr	120–150 mmHg (0.20 bar)

After the procedure

- Monitor the child for several minutes.
- Inform the child's parent or caregiver that coughing may be more frequent for 24 hours after the procedure.
- Transfer the full volume of sample into a sterile container (Falcon tube).
- Clean the Falcon tube with alcohol swabs.
- Label the sample with sample type and number, date, time and total sample volume.
- Place the specimen in a sample bag, seal and prepare for transport.

Sputum induction³³

Background

Sputum induction is typically done in people of any age who are unable to produce sputum spontaneously. The patient inhales nebulized hypertonic saline solution, which liquefies airway secretions, promotes coughing and allows expectoration of respiratory secretions. In young children, inhalation of hypertonic saline does not always trigger expectoration. When expectoration does not occur, NPA is usually required for sputum collection.

Sputum induction is regarded as a low-risk procedure for the child or adolescent to be evaluated for TB. The very few adverse events that have been reported include coughing spells, mild wheezing and nosebleeds. The procedure can be performed safely even in young infants, although staff will need to have specialized training and equipment to perform the procedure in such patients and infection control measures must be observed. Examine children and adolescents in advance to ensure they are well enough to undergo the procedure.

Children and adolescents with the following characteristics should not undergo sputum induction:

- not fasted for 3 hours;
- oxygen saturation less than 92% in room air or cyanosis;
- severe respiratory distress and vital signs outside normal parameters;
- moderate to severe wheezing;
- severe cough;
- bleeding – low platelet count, nosebleeds or other bleeding source;
- reduced level of consciousness.

Materials needed

- non-sterile gloves;
- particulate respirator Masks (N95 or equivalent);
- disposable apron;
- protective eyeglasses;
- salbutamol (100 µg/puff);
- spacer;
- oxygen concentrator with mask or nasal cannula;
- pulse oximeter;
- nebulizer and tubing;
- nebulization mask of different sizes or mouthpiece;
- antibacterial filter;
- sterile hypertonic saline solution (3–5%);
- 5–10 mL syringes;
- sputum container;
- suction pump;
- sterile nasogastric catheter (6–10 Fr) or mucus extractor (6/7/8 G);
- one or two bedsheets to wrap the child;
- optional oxymetazoline (to prevent epistaxis);
- mucus trap;
- sterile saline solution;
- cotton wool;
- alcohol or chlorhexidine
- disinfectant for medical equipment;
- sterile sample container (Falcon tubes);
- laboratory request form;
- permanent marker or pen;
- antiseptic soap.

Procedure

Sputum induction is performed by a nurse or other clinician trained in the technique and is undertaken after a 2–3 hour fast. General observations and chest auscultation should be documented. Oxygen

³³ Adapted from *Guidance for national tuberculosis programmes on the management of tuberculosis in children*, second edition. Geneva: World Health Organization; 2014; and *Standard operating procedures: collection, transport and processing of induced sputum*. CaP-TB project.

saturation and pulse rate must be monitored throughout the procedure. The procedure must be stopped in the event of a fall in saturation below 90% and a pulse over 180/minute or below 100/minute.

- Explain the procedure to the child or adolescent and to their parent or caregiver (if present).
- Administer a bronchodilator (e.g. salbutamol 200 µg via a metered dose inhaler with attached spacer) to prevent bronchoconstriction. Wait 15 minutes before starting nebulization.
- Fill the medication chamber cup of the nebulizer with 10 mL of sodium chloride 5% solution.
- Administer nebulized hypertonic saline (5% NaCl) for 15 minutes or until the reservoir is empty.
- Carry out chest physiotherapy (lightly clapping or percussing on the back, chest and underarms of the child using cupped hands) if necessary to mobilize secretions.
- For older children and adolescents who are able to expectorate:
 - Encourage the child or adolescent to expectorate sputum into a sputum container. The child or adolescent should continue to expectorate until no more sputum can be produced. Nebulization can be repeated if an inadequate sample is obtained (less than 1 mL or watery sample indicative of saliva).
 - If the child or adolescent does not cough after nebulization, encourage them to perform deep breathing or to jump or run on the spot if clinically stable and able to do so. Chest percussion is done over the anterior and posterior chest wall. Encourage the child or adolescent to expectorate as above.
 - If less than 1–2 mL of sputum is collected, repeat nebulization with another 5 mL of sodium chloride 5%, until at least 2 mL of sputum is collected, allowing for an interval of at least 30 minutes between the end of one nebulization and the start of the next. No more than three consecutive nebulizations are recommended in one session.
 - Seal the specimen container tightly.
 - Ensure the child or adolescent is wearing a surgical mask before they leave the sputum induction room.
- For young children who are unable to expectorate:
 - Obtain sputum by suctioning through the nasopharynx with a sterile mucus extractor or nasogastric catheter (see procedure for nasopharyngeal aspiration).

Any equipment that will be reused must be disinfected and sterilized before use with subsequent patients.

Annex 5. Treatment decision algorithms

Methodology for developing the treatment decision algorithms

Individual-level participant diagnostic evaluations and outcome data in children aged under 10 years presenting for evaluation of PTB were solicited from studies carried out in geographically diverse high TB burden settings. Missing data were imputed using multiple imputations by chained equations. Prediction models were built to classify participants as having TB (confirmed or unconfirmed TB) or unlikely TB using features from clinical evaluation and CXR as predictors. The predictors were selected based on those commonly used in the evaluation of children with PTB that were available in the individual participant data. An additional model was built excluding CXR features to assess performance in settings where CXR may not be available. Model predictor coefficients were estimated using meta-analytical methods used for clustered and multiply imputed individual participant data. Model generalizability and validation were assessed using an internal/external leave-one-study-out cross-validation framework.

After considering the implications of different sensitivity and specificity cut-offs, a panel of childhood TB experts reached consensus on selecting a modelled probability threshold to classify pulmonary TB at 85% sensitivity. The model coefficient estimates for the predictors were scaled to produce a score such that a child with a set of features resulting in a total score over 10 constituted a classification of pulmonary TB with a sensitivity of 85%. The associated specificity of a total score over 10 is 37% for the algorithm with and 30% for the one without CXR features. It is important to note that the sensitivity and specificity apply only to the scored part of the algorithms, shown in the yellow boxes in algorithms A and B (Figure A5.1).

Triage steps were included in the final algorithms, prior to children entering the scoring part to improve the accuracy of prediction and the safety of algorithm use. Triage steps first assess for danger signs that may require immediate management or referral (as per IMCI guidance in children aged under 5 years), risk-stratifying based on risk of disease progression, and for low-risk children providing treatment for alternative diagnoses first before a re-evaluation. The use of mWRDs where available is included in the algorithms before scoring of signs and symptoms and CXR features. These steps should improve diagnostic accuracy. The performance of the algorithm will be assessed through ongoing external validation.

During the guideline development group meeting in May–June 2021, the group reflected on the consequences of false-negative and false-positive conclusions based on integrated treatment decision algorithms. The group agreed that it was most important to avoid missing a TB diagnosis in a child who has TB, while accepting a certain degree of over-diagnosis, considering the large case detection gap and the consequences of a missed diagnosis of TB.

Treatment decision algorithms and operational guidance

Figure A5.1. Algorithm A (for settings with chest X-ray) and Algorithm B (for settings without chest X-ray)

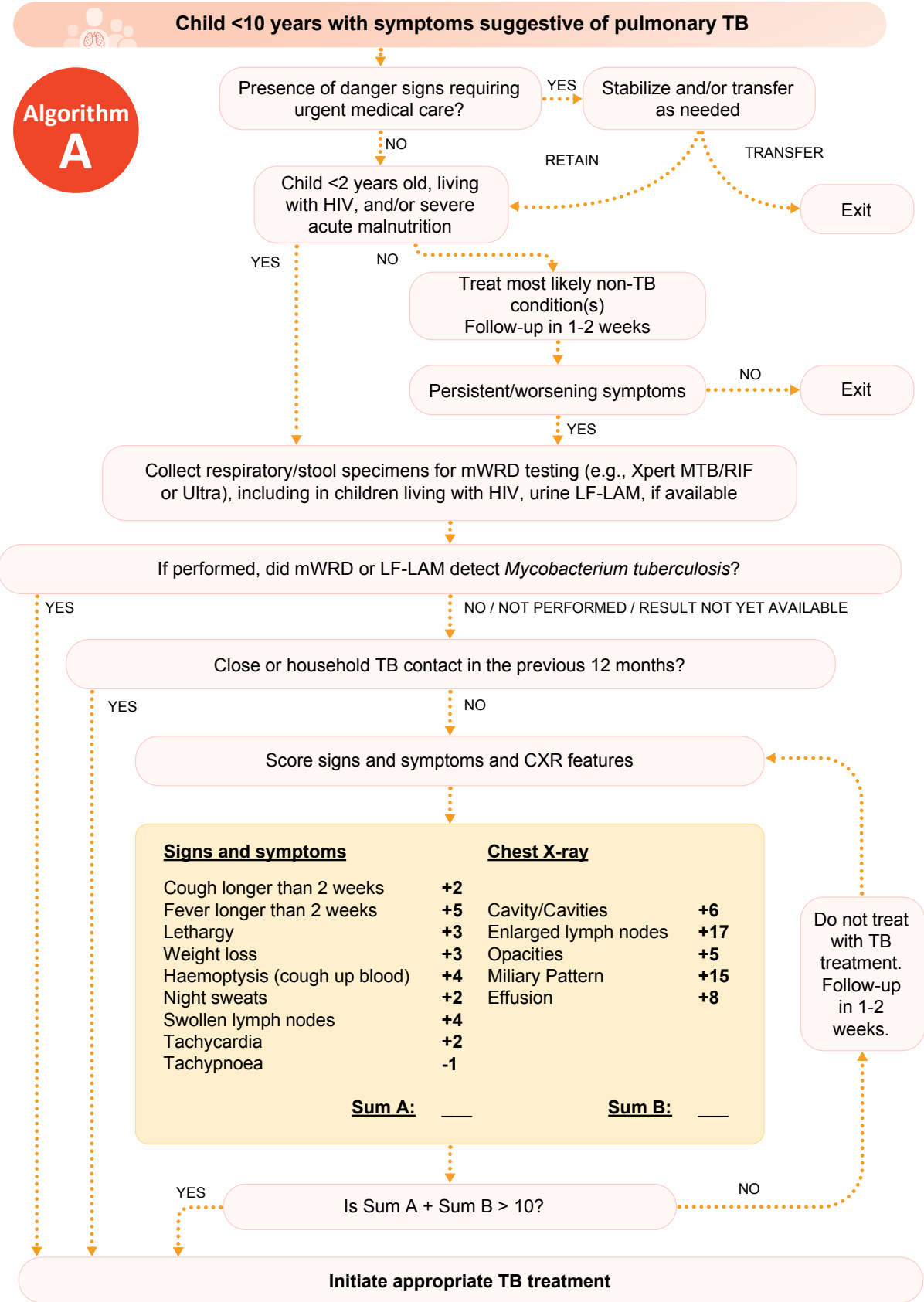

Child <10 years with symptoms suggestive of pulmonary TB

Algorithm B

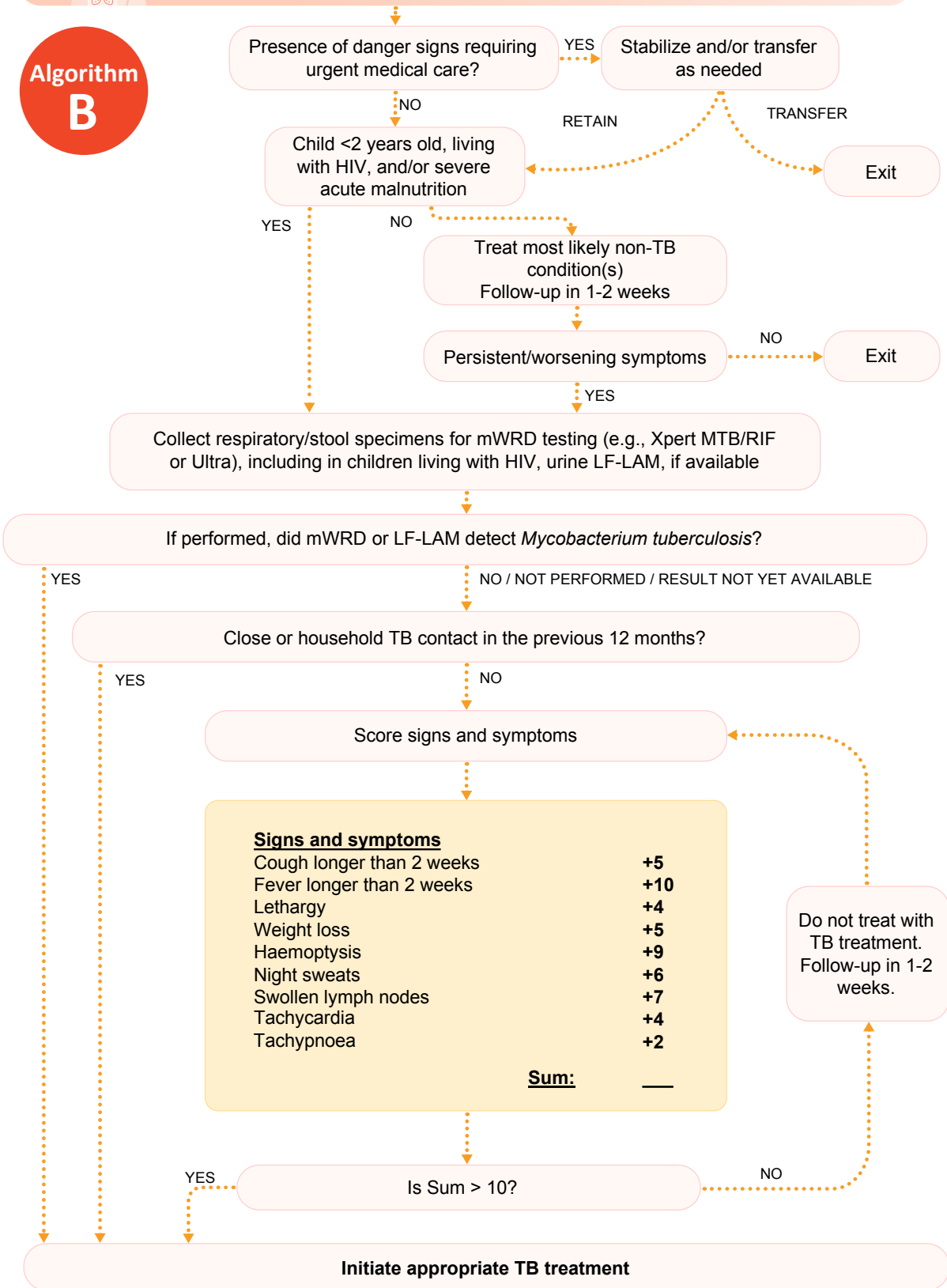

Using the integrated treatment decision algorithms

Algorithms A and B have been developed to support health workers in the evaluation of children brought to health services due to parental or caregiver concern about their symptoms, or for child contacts who have screened positive (via symptoms or CXR screening) and been identified by HCWs as having presumptive TB. Children are classified as having presumptive TB if they have unremitting symptoms lasting more than 2 weeks (any one of cough, fever, not eating well or anorexia, weight loss or failure to thrive, fatigue, reduced playfulness or decreased activity). Definitions of symptoms can be found in [Box A5.1](#).

These algorithms are not intended to guide the management of children identified by active case-finding strategies or to evaluate asymptomatic children identified as being at high risk of TB or following exposure to a person with infectious TB (see Chapters 2 and 3 on screening and contact investigation and prevention).

Algorithm A can be used in contexts where CXR is available. Algorithm B can be used in contexts where CXR is not available.

The first step in both algorithms is to determine whether the child has signs and symptoms that indicate an urgent health problem. In children aged under 5 years, these signs and symptoms typically refer to “danger signs”, as defined by the IMCI approach³⁴. In older children, these signs and symptoms are defined in paediatric emergency triage, assessment and treatment (ETAT)³⁵. Important danger and priority signs are described in [Table A5.1](#).

Table A5.1. Danger and priority signs of severe illness or health problems in children aged under 10 years

Aged <5 years	Aged 5–9 years	All children aged <10 years
Danger signs (IMCI)	Danger signs (ETAT)	Priority signs
Gastrointestinal/circulatory: <ul style="list-style-type: none"> • Unable to eat or drink • Vomiting up everything • Signs of severe dehydration (sunken eyes, skin pinch returns very slowly) • Severe palmar pallor 	Gastrointestinal/circulatory: <ul style="list-style-type: none"> • Diarrhoea with any two signs of severe dehydration (lethargy, unconsciousness, sunken eyes, very slow return of skin after pinching) • Signs of shock (cold extremities with capillary refill time >3 seconds, weak and fast pulse) 	<ul style="list-style-type: none"> • Any sick child aged <2 months • High fever (>39° C) • Severe pallor • Respiratory distress • Restless, continuously irritable, lethargic • SAM
Respiratory: <ul style="list-style-type: none"> • Stridor • Oxygen saturation <90% 	Respiratory: <ul style="list-style-type: none"> • Obstructed or absent breathing • Severe respiratory distress • Central cyanosis 	

³⁴ Integrated Management of Childhood Illness: chart booklet. Geneva: World Health Organization; 2014 (<http://thepafp.org/website/wp-content/uploads/2017/05/2014-IMCI.pdf>, accessed 1 December 2021).

³⁵ Updated guideline: paediatric emergency triage, assessment and treatment – care of critically ill children. Geneva: World Health Organization; 2016 (https://apps.who.int/iris/bitstream/handle/10665/204463/9789241510219_eng.pdf?sequence=1&isAllowed=y, accessed 8 March 2022).

Aged <5 years	Aged 5–9 years	All children aged <10 years
Danger signs (IMCI)	Danger signs (ETAT)	Priority signs
Neurological: <ul style="list-style-type: none"> • Seizures • Profoundly lethargic, unconscious • Neck stiffness or bulging fontanelle 	Neurological: <ul style="list-style-type: none"> • Coma (or seriously reduced level of consciousness) • Seizures 	

If any of these signs is present, the child should be stabilized and referred to a higher level of care as appropriate. Once stabilized, the child with presumptive TB should continue to be evaluated using Algorithm A or B. Children with presumptive TB are then stratified based on their risk of rapid TB disease progression:

- ➔ High-risk children include those aged under 2 years, living with HIV or with SAM (defined as weight-for-height Z-score less than –3 standard deviations or mid-upper arm circumference below 115 mm). For these high-risk children, a respiratory sample (expectorated or induced sputum, NPA sample, gastric aspirate or stool) should be collected for testing with mWRD (e.g. Xpert MTB/RIF or Xpert Ultra) if available. For children living with HIV, a urine specimen should be collected and sent for LF-LAM testing if available. If the Xpert or LF-LAM result is positive, TB treatment should be started. If Xpert or LF-LAM is not available, or if the result is negative, or if there will be a delay before receiving the results, high-risk children should enter the next step in either of the algorithms.
- ➔ Lower-risk children include those who do not have any of the high-risk characteristics (i.e. an HIV-negative child aged 2 years or older without SAM). These children should first be managed and treated for the most likely diagnosis based on the presenting signs and symptoms (e.g. asthma, pneumonia, pertussis, malaria). This would commonly include a course of broad-spectrum antibiotics and clinical review after 1–2 weeks. If the child has persistent or worsening symptoms when evaluated after 1–2 weeks, they should provide samples for testing with mWRD (e.g. Xpert MTB/RIF or Xpert Ultra). If Xpert is positive, TB treatment should be started. If Xpert is unavailable or negative or there will be a delay before receiving the result, the child should enter the next step in either of the algorithms.
- ➔ Children with unknown HIV status should be offered rapid HIV testing accompanied by pre- and post-test counselling in accordance with WHO recommendations for children with presumptive TB or TB exposure. This allows the child to be placed into the appropriate risk group to inform clinical management, as described above.

When evaluating a child using either of the algorithms, the following steps are implemented:

- ➔ While taking the clinical history, the health worker or clinician should identify whether the child has been exposed to a person with infectious (Xpert-, smear- or culture-positive) PTB in the past 12 months. This might include household exposure or close exposure to a person outside the home. If the child has been exposed to a person with infectious TB, the child should begin TB treatment immediately.
- ➔ If there is no identified TB exposure, the next step is to assess the features in the yellow part of the algorithm using information collected during the clinical history and physical examination of the child and CXR if available. When a feature is present, the corresponding score is noted, and the scores are added up:

- Algorithm A is used when CXR is available. Scores from the signs and symptoms (left part of the yellow box) and the CXR (right part of the yellow box) are combined. The CXR can be done at any point during the evaluation (in parallel with or after scoring signs and symptoms from the clinical history and physical examination). The scores from the two parts of the yellow box are added. A decision to start treatment is made based on a score over 10. This may be achieved using only the left part of the yellow box (clinical history and physical examination score) while awaiting the CXR result, or with consideration of the CXR result once it is available. It is advisable to do a CXR as part of the evaluation as it is an important tool to determine severity of disease and may also support an alternative diagnosis.
 - Algorithm B is used when CXR is not available. It features only the signs and symptoms section based on clinical history and physical examination (yellow box). (Note that scores in this section are distinct from those in Algorithm A.) A decision to start treatment is made based on a score over 10.
- ➔ In either algorithm, if the child's total score is over 10, the child should start TB treatment using a WHO-recommended regimen.
- ➔ If the score is 10 or less, the child should not start TB treatment but should return in 1–2 weeks to undergo a repeat clinical history and physical examination.

Box A5.1 Example of scoring via algorithm A

- If a child has a cough for more than 2 weeks (+2 points), lethargy (+3 points), tachycardia (+2 points) and none of the stated radiological features on CXR (cavities, enlarged lymph nodes, opacities, miliary pattern or effusions), the child is assigned 7 points and should not start TB treatment. The child should be treated for the most likely alternative diagnosis and reassessed in 1–2 weeks.
- If a child has weight loss (+3 points), swollen lymph nodes (+4 points) and opacities on CXR (+5 points), the child is assigned 12 points and should start TB treatment.

Box A5.2 Example of scoring via Algorithm B

- If a child has a cough for more than 2 weeks (+5 points), fever for 5 days (0 points as it is less than 2 weeks), and tachypnoea (+2 points), the child is assigned 7 points and should not start TB treatment. The child should be treated for the most likely alternative diagnosis and reassessed in 1–2 weeks.
- If a child has a cough for more than 2 weeks (+5 points), weight loss (+5 points) and swollen lymph nodes (+7 points), the child is assigned 17 points and should start TB treatment.

When a decision to treat for TB has been made, the HCW must complete two additional evaluations to inform the choice of treatment regimen:

- ➔ Assessment for risk factors for the child having DR-TB: DR-TB should be considered when there is:
1. contact with a confirmed or presumed person with DR;
 2. a poor response to first-line treatment after 2–3 months; or
 3. previous TB treatment in the past 12 months (see [Section 4.6](#)).
- ➔ Children with risk factors for DR-TB should be referred to the appropriate level of care as needed.

- Determination of whether the child has severe or non-severe disease to inform selection of treatment regimen: non-severe PTB is defined as intrathoracic lymph node TB without airway obstruction; and uncomplicated TB pleural effusion or paucibacillary, non-cavitary disease confined to one lobe of the lungs and without a miliary pattern (additional details regarding determination of severity of disease when CXR and Xpert are not available are included in [Section 5.2.4](#)). Children with non-severe, presumed drug-susceptible TB should receive a 4-month treatment regimen. (See [Chapter 5](#) for information on regimens for the treatment of drug-susceptible TB and DR-TB.)

All children with a decision to start TB treatment should be registered and notified to the NTP.

Box A5.3 Definitions of symptoms suggestive of pulmonary TB included in treatment decision algorithms

- Cough: persistent, unremitting cough for 2 weeks or more.
- Fever: persistent fever for 2 weeks or more (the score in the algorithm is based on the duration of fever as per the history rather than the actual temperature on examination).
- Lethargy: persistent unexplained lethargy or decrease in playfulness or activity reported by the parent or caregiver.
- Weight loss: more than 5% reduction in weight compared with the highest weight recorded in the past 3 months, or failure to thrive (clear deviation from previous growth trajectory, or documented crossing of percentile lines in the preceding 3 months, or WFA Z-score of -2 or less, or weight-for-height Z-score of -2 or less in the absence of information on previous or recent growth trajectory).
- Haemoptysis: expectoration of blood or blood-tinged sputum. This is a very rare symptom in children aged under 10 years and should be distinguished carefully from blood brought up by a child following a nosebleed.
- Night sweats: excessive night-time sweating that soaks the bed or clothes.
- Swollen lymph nodes: non-painful, enlarged cervical, submandibular or axillary lymph nodes.
- Tachycardia:
 - children aged under 2 months: heart rate over 160 beats/minute;
 - children aged 2–12 months: heart rate over 150 beats/minute;
 - children aged 12 months to 5 years: heart rate over 140 beats/minute;
 - children aged over 5 years: heart rate over 120 beats/minute.
- Tachypnoea:
 - children aged under 2 months: respiratory rate over 60/minute;
 - children aged 2–12 months: respiratory rate over 50/minute;
 - children aged 12 months to 5 years: respiratory rate over 40/minute;
 - children aged over 5 years: respiratory rate over 30/minute.
- If a child has weight loss (+3 points), swollen lymph nodes (+4 points) and opacities on CXR (+5 points), the child is assigned 12 points and should start TB treatment.

Annex 6. Dosing of medicines used in second-line multidrug-resistant TB regimens by weight band (below 46 kg)^a

- Dosing guidance is based on currently available data and may be revised once additional data are available.
- For patients weighing ≥ 46 kg, please refer to Table A in Annex 1 of the [WHO operational handbook on tuberculosis. Module 4: treatment – drug-resistant tuberculosis](#): Dosing of medicines used in second-line multidrug-resistant TB regimens by weight band (patients 15 years or older).
- For dosing of premature and low birth weight infants weighing < 3 kg, advice from a paediatric DR-TB expert should be sought.
- For dosing of infants weighing 3 to < 5 kg, a paediatric DR-TB expert should be consulted whenever possible.
- The use of child-friendly, dispersible tablets in infants and young children is preferred over manipulating adult tablets or administering/manipulating capsules. Where applicable, the dosing provided is based on dissolving the dispersible formulation in 10 mL of water and administering the number of mL (aliquots). The dissolved solution should be used immediately and the remainder of the 10 mL should be discarded.
- For some weight bands, dosing is indicated with both child-friendly, dispersible formulations and adult formulations. If adult formulations are used, the table provides the dose using aliquots in mL and tablet fractions where applicable (if the fraction is 0.5 or more). Aliquots refer to the volume to administer after crushing and dissolving the tablet in 10 mL of water.

Group	Medicine	Weight-based daily dose ^b	Formulations (mg/mL, as applicable)	Weight bands ^a								Usual upper daily dose ^b	Comments
				3 to <5 kg	5 to <7 kg	7 to <10 kg	10 to <16 kg	16 to <24 kg	24 to <30 kg	30 to <36 kg	36 to <46 kg		
A	Levofloxacin	15–20 mg/kg	100 mg dt (100 mg in 10 mL = 10 mg/mL)	5 mL (0.5 dt)	1	1.5	2	3	-	-	-	1.5 g	
			250 mg tab (250 mg in 10 mL = 25 mg/mL)	2 mL ^c	5 mL (0.5 tab) ^c	5 mL (0.5 tab) ^c	1	1.5	2	3	3	1.5 g	
	Moxifloxacin	10–15 mg/kg (standard dose) ^d	100 mg dt (100 mg in 10 mL = 10 mg/mL)	4 mL	8 mL	1.5	2	3	4	4	4	400 mg	
			400 mg tab (400 mg in 10 mL = 40 mg/mL)	1 mL ^c	2 mL ^c	3 mL ^c	5 mL ^c (0.5 tab)	7.5 mL ^c (0.75 tab)	1	1	1	400 mg	
		High dose ^d	400 mg tab	-	-	-	-	-	-	1 or 1.5	1.5	800 mg	
	Bedaquiline	-	20 mg dt	0 to <3 months: 1.5 od for 2 weeks; then 0.5 od M/W/F for 22 weeks ≥ 3 months: 3 od for 2 weeks; then 1 od M/W/F for 22 weeks	0 to <3 months: 1.5 od for 2 weeks; then 0.5 od M/W/F for 22 weeks 3 to <6 months: 3 od for 2 weeks; then 1 od M/W/F for 22 weeks ≥ 6 months: 4 od for 2 weeks; then 2 od M/W/F for 22 weeks	3 to <6 months: 3 od for 2 weeks; then 1 od M/W/F for 22 weeks ≥ 6 months: 6 od for 2 weeks; then 3 od M/W/F for 22 weeks	10 od for 2 weeks; then 5 od M/W/F for 22 weeks	20 od for 2 weeks; then 10 od M/W/F for 22 weeks	-	-	-	-	
		-	100 mg tab ^e (100 mg in 10 mL = 10 mg/mL)	0 to <3 months: 3 mL od for 2 weeks; then 1 mL od M/W/F for 22 weeks ^c ≥ 3 months: 6 mL od for 2 weeks; then 2 mL od M/W/F for 22 weeks ^c	0 to <3 months: 3 mL od for 2 weeks; then 1 mL od M/W/F for 22 weeks ^c 3 to <6 months: 6 mL od for 2 weeks; then 2 mL od M/W/F for 22 weeks ^c ≥ 6 months: 8 mL od for 2 weeks; then 4 mL od M/W/F for 22 weeks ^c	3 to <6 months: 6 mL od for 2 weeks; then 2 mL od M/W/F for 22 weeks ^c ≥ 6 months: 12 mL od for 2 weeks; then 6 mL od M/W/F for 22 weeks ^c	2 od for 2 weeks; then 1 od M/W/F for 22 weeks	4 od for 2 weeks; then 2 od M/W/F for 22 weeks	-	-	-	-	A daily loading dose is used for the first 2 weeks, followed by a maintenance dose given three times a week

Group	Medicine	Weight-based daily dose ^b	Formulations (mg/mL, as applicable)	Weight bands ^a								Usual upper daily dose ^b	Comments
				3 to <5 kg	5 to <7 kg	7 to <10 kg	10 to <16 kg	16 to <24 kg	24 to <30 kg	30 to <36 kg	36 to <46 kg		
	Linezolid	15 mg/kg od in 1–15 kg; 10–12 mg/kg od in ≥ 15 kg	20 mg/mL suspension	2 mL	4 mL	6 mL	8 mL	11 mL	14 mL	15 mL	20 mL	600 mg	
			150 mg dt ^f (150 mg in 10 mL = 15 mg/mL)	2.5 mL	5 mL (0.5 dt)	1	1	2 ^g	2	2	3		
			600 mg tab (600 mg in 10 mL = 60 mg/mL)	-	1.25 mL ^c	2.5 mL ^c	2.5 mL ^c	5 mL ^{c,9}	5 mL (0.5 tab) ^c	5 mL (0.5 tab) ^c	7.5 mL (0.75 tab) ^c		
B	Clofazimine	2–5 mg/kg (when dosed daily)	50 mg cap or tab ^h	1 M/F	1 M/W/F	1 M/W/F	1	1	2	2	2	100 mg	For children <24 kg, the use of the 50 mg tab is preferred
			100 mg cap or tab ^h	-	1 M/F	1 M/F	1 M/W/F	1 M/W/F	1	1	1	100 mg	
	Cycloserine or terizidone	15–20 mg/kg in 7 to <30 kg ⁱ 10–15 mg/kg in ≥30kg	125 mg mini capsule (cycloserine) (125 mg in 10 mL = 12.5 mg/mL)	2 mL ^c	4 mL ^c	1	2	3	4	4	4	1 g	In children 3 to <7 kg dosing is lower than previously recommended in light of relatively high exposures observed in updated PK models
			250 mg cap (250 mg in 10 mL = 25 mg/mL)	1 mL ^c	2 mL ^c	5 mL ^c	1	2	2	2	2	1 g	
C	Ethambutol	15–25 mg/kg	100 mg dt (100 mg in 10 mL = 10 mg/mL)	5 mL (0.5 dt)	1	2	3	4	-	-	-	-	
			400 mg tab (400 mg in 10 mL = 40 mg/mL)	1.5 mL ^c	3 mL ^c	4 mL ^c	6 mL ^c	1	1.5	2	2		
	Delamanid	-	25 mg dt ^j	1 od	<3 months: 1 od ≥ 3 months: 1 bd	1 bd	2 morning 1 evening	2 bd	2bd	-	-	-	
			50 mg tab ^j (50 mg in 10 mL = 5 mg/mL)	5 mL (0.5 tab) od ^c	<3 months: 5 mL (0.5 tab) od ^c ≥ 3 months: 5 mL (0.5 tab) bd ^c	5 mL (0.5 tab) bd ^c	10 mL (1 tab) morning 5 mL (0.5 tab) evening	1 bd ^k	1 bd ^k				

Group	Medicine	Weight-based daily dose ^b	Formulations (mg/mL, as applicable)	Weight bands ^a								Usual upper daily dose ^b	Comments
				3 to <5 kg	5 to <7 kg	7 to <10 kg	10 to <16 kg	16 to <24 kg	24 to <30 kg	30 to <36 kg	36 to <46 kg		
	Pyrazinamide	30–40 mg/kg	150 mg dt (150 mg in 10 mL = 15 mg/mL)	5 mL (0.5 dt)	1	2	3	5	-	-	-	-	
			400 mg tab (400 mg in 10 mL = 40 mg/mL)	2.5 mL ^c	5 mL (0.5 tab) ^c	7.5 mL (0.75 tab) ^c	1	2	2.5	3	4		
			500 mg tab (500 mg in 10 mL = 50 mg/mL)	2 mL ^c	5 mL (0.5 tab) ^c	5 mL (0.5 tab) ^c	1	1.5	2	2	3		
	Imipenem-cilastatin	-	500 mg + 500 mg powder for injection, vial (10 mL)	Not used in patients <15 years (use meropenem)						2 vials (1g + 1g) bd		-	
	Meropenem	20–40 mg/kg iv every 8 hours	1 g powder for injection, vial (20 mL)	1 ml	2 ml	4 ml	6 ml	9 ml	11 ml	1 vial 3 times per day or 2 vials bd		-	Only to be used with clavulanic acid
	Amikacin ^l	-	500 mg/2 mL vial	Not recommended by WHO in children and adolescents below 18 years of age, but if used as salvage therapy, calculate according to dilution used								-	
	Streptomycin ^l	-	1 g vial	Not recommended by WHO in children and adolescents below 18 years of age, but if used as salvage therapy, calculate according to dilution used								-	
	Ethionamide or prothionamide	15–20 mg/kg	125 mg dt (ethionamide) (125 mg in 10 mL = 12.5 mg/mL)	3 mL ^c	7 mL ^c	1	2	3	4	4	4	1 g	In case of intolerance, the same total daily dose can be given in 2 divided doses or separate from other second-line TB drugs (expert opinion)
			250 mg tab (250 mg in 10 mL = 25 mg/mL)	-	3 mL ^c	5 mL (0.5 tab) ^c	1	2	2	2	2	1 g	
	<i>p</i> -aminosalicylic acid	200–300 mg/kg in 2 divided doses	PAS sodium salt (equivalent to 4 g PAS acid) sachet	0.3 g bd	0.75 g bd	1 g bd	2 g bd	3 g bd	3.5 g bd	4 g bd	4 g bd	-	Full dose can be given once daily in the evening if tolerated (expert opinion)

Group	Medicine	Weight-based daily dose ^b	Formulations (mg/mL, as applicable)	Weight bands ^a								Usual upper daily dose ^b	Comments
				3 to <5 kg	5 to <7 kg	7 to <10 kg	10 to <16 kg	16 to <24 kg	24 to <30 kg	30 to <36 kg	36 to <46 kg		
Other medicines ^m	Isoniazid	15–20 mg/kg (high dose)	100 mg dt (100 mg in 10 mL = 10 mg/mL)	5 mL (0.5 dt)	1	1.5	2	3	4	4	4.5		300 mg isoniazid tab can be used in patients ≥16 kg. Pyridoxine is always given with high-dose isoniazid in children (1–2 mg/kg) ⁿ
			50 mg/5 ml soln	5 ml	9 ml	15 ml	20 ml	-	-	-	-		
	Clavulanic acid (as amoxicillin/clavulanate) ^o	-	62.5 mg clavulanic acid as amoxicillin/clavulanate, 250 mg/62.5, powder for oral solution, 5 mL ^o	1.5 ml bd ^o	2 ml bd ^o	3 ml bd ^o	5 ml bd ^o	8 ml bd ^o	10 ml bd ^o	10 ml bd ^o	10 ml bd ^o		Only to be used with carbapenems. For children and adolescents weighing ≥30 kg, the 500 mg/125 mg amoxicillin/clavulanate tablet can be used (see Table A)

AEs: adverse events; bd: two times a day; cap: capsule; dt: dispersible tablet; g: gram; kg: kilogram; mL: milliliter; mg: milligram; M/W/F: Monday, Wednesday, Friday; od: once daily; soln: solution; susp: suspension; tab: tablet.

^a Dosages were established by the guideline development groups for the WHO guidelines on drug-resistant tuberculosis treatment (2018 and 2020 updates), the WHO Global Task Force on the Pharmacokinetics and Pharmacodynamics (PK/PD) of TB medicines and the expert group convened after the guideline development group on child and adolescent TB in 2021 and 2022. They are based on the most recent reviews and best practices in the treatment of (paediatric) MDR/RR-TB. For certain medicines the dosages were informed by pharmacokinetic modelling results based on the principle of allometric scaling and maturation (Denti P, Wasmann RE, Francis J, et al. One dose does not fit all: revising the WHO paediatric dosing tool to include the non-linear effect of body size and maturation. *Lancet Child Adolesc Health*. 2022;6(1):9–10). Due to the pharmacokinetic properties of certain medicines the doses proposed may exceed the mg/kg/day ranges shown here in order to achieve blood concentrations similar to target levels in an average adult patient. The guidance for the 3–<5kg weight band and for bedaquiline and delamanid is based on currently available data and may be revised when new data becomes available.

^b Clinicians may decide to exceed these values in particular cases to improve therapeutic effect. In infants weighing less than 10 kg, consultation with an expert in paediatric DR-TB is advised, in view of limited data on maturation.

^c Dissolving of crushed adult tablets or capsule content in 10 mL of water is required for administering this dose. The number of mL in the table reflects the dose to provide. This avoids fractioning solid formulations, although bioavailability of the dissolved, crushed adult tablets is uncertain (use of dispersible tablets is preferred if available).

^d The higher dose may be used except when: there is risk of toxicity; levels are expected to be lowered because of pharmacokinetic interactions, malabsorption or other reasons; or the strain has low-level drug resistance.

- ^e Bedaquiline adult tablets (100 mg) crushed and suspended in water have been shown to be bioequivalent to tablets swallowed whole. Vigorous stirring/shaking is needed prior to administering the 100 mg tablet crushed and suspended in water.
- ^f The 150 mg dispersible tablet for linezolid is expected to become available in 2022.
- ^g When using the 600 mg tab and the 150 mg dt to dose children weighing 16 to <24 kg, the dose in mg/kg will exceed 10–12 mg/kg and clinicians may opt to administer 1.5 dt or 4 mL of the 600 mg tab dispersed in 10 mL of water.
- ^h Clofazimine tablets are technically not dispersible but they do slowly (this takes approximately 5 minutes) dissolve in water (5 mL and 10 mL for the 50 mg and 100 mg tablets, respectively). The suspension should be stirred prior to administration. The 100 mg soft gel capsule is difficult to swallow for young children and therefore countries are strongly encouraged to make the 50 mg tablet formulation available.
- ⁱ In children weighing 3 to <7 kg doses are lower than previously recommended. This is because of relatively high exposures associated with risk of neuropsychiatric AEs, which is especially concerning when co-administering cycloserine with delamanid
- ^j Delamanid adult tablets (50 mg) crushed and suspended in water have been shown to be bioequivalent to tablets swallowed whole.
- ^k The dose for delamanid in children and young adolescents weighing 30 to < 46 kg differs from the dose provided for older adolescents and adults in the same weight band in Table A (Module 4: Operational Handbook DR-TB).
- ^l Amikacin and streptomycin may be used in adults aged 18 years or more, in situations where an effective regimen cannot otherwise be designed using oral agents, when susceptibility is demonstrated, and when adequate measures are in place to monitor for adverse events. Given the profound impact that hearing loss can have on the acquisition of language and the ability to learn at school, the use of injectable agents in children should be exceptional and limited to salvage therapy, and the treatment needs to be provided under strict monitoring to ensure early detection of ototoxicity. If used, the weight-based daily dose for amikacin is 15–20 mg/kg and for streptomycin is 20–40 mg/kg for children over 2 years. To determine the dosing for infants and children < 2 years, a paediatric DR-TB expert should be consulted and a lower mg/kg dose used to compensate for immature clearance. Co-administration with lidocaine is advised to reduce pain at injection site (Garcia-Prats A, Rose PC, Draper HR et al. Effect of Coadministration of Lidocaine on the Pain and Pharmacokinetics of Intramuscular Amikacin in Children with Multidrug-Resistant Tuberculosis: A Randomized Crossover Trial. *Pediatr Infect Dis J*. 2018 Dec;37(12):1199–1203).
- ^m These medicines are only recommended as a companion agent (amoxicillin/clavulanic acid) or are not included in groups A, B and C, because of a lack of data from the latest analysis on longer MDR-TB regimens in adults (isoniazid).
- ⁿ In infants, pyridoxine may be given as part of a multi-vitamin syrup.
- ^o Only to be used with the carbapenems, and only available in combination with amoxicillin as co-amoxiclav. For example, for the 24 to <30 kg weight band, amoxicillin/clavulanate, 500/125 mg bd is given.

Annex 7. Overview of options for neurocognitive and functional testing at end of treatment for TB meningitis

Table A7.1. Options for neurocognitive and functional testing at end of treatment for TB meningitis

Outcome	Measure	Timing
Neurodevelopmental	Minimal: <ul style="list-style-type: none"> • Ages and Stages Questionnaire (age range 0–5 years) ^a Optimal: <ul style="list-style-type: none"> • Bailey Scale of Infant Development, 3rd edition (age range 1–42 months) ^b • Mullen Scale Early Learning (age range 0–68 months) ^c 	Post-acute: 6–9 months, 2 years, 4 years
Neurocognitive	<ul style="list-style-type: none"> • Wechsler Intelligence Scales for Children (age range 6–16 years) ^d • Kauffman Assessment Battery for Children, 2nd edition (age range 3–8 years) ^e 	Post-acute: 6–9 months Long-term throughout schooling (2 and 5 years minimum)
Functional	Minimal: <ul style="list-style-type: none"> • Modified Rankin Scale (age range 1 year–adult) • WHO Disability Assessment Schedule 2.0 (age range 12 years–adult) ^f Optimal: <ul style="list-style-type: none"> • Vineland Adaptive Behaviour Scale (age range birth to adult) ^g 	Post-acute: 6–9 months Long-term throughout schooling (2 and 5 years minimum)
Neurobehavioural	Minimal: <ul style="list-style-type: none"> • Strengths and Difficulties Questionnaire (age range 4–17 years) • Child, parent, teachers forms 	Post-acute: 6–9 months Long-term throughout schooling (2 and 5 years minimum)

Note: these developmental assessment tools have not been formally adapted for use in low- and middle-income countries, and locally determined norms have not been developed. Interpretation of results requires careful consideration of the local context. A number of in-country locally developed screening tools are also available.

^a Ages and stages questionnaire, 3rd edition. Baltimore, MD: Brookes Publishing; 2009.

^b Bayley N. Scales of Infant and Toddler Development III (screening test). San Antonio, TX: Pearson; 2005.

^c Torrance CW, editor. Mullen Scales of Early Learning. 1995.

^d Wechsler Intelligence Scale for Children (WISC-IV), 4th edition. San Antonio, TX: Psychological Corporation; 2003.

^e Kaufman Assessment Battery for Children 2. Circle Pines, MN: American Guidance Service; 2004.

^f WHO Disability Assessment Schedule 2.0. Geneva: World Health Organization; 2010 (<https://www.who.int/standards/classifications/international-classification-of-functioning-disability-and-health/who-disability-assessment-schedule>).

^g Sparrow SS, Cicchetti DV B DA. Vineland Adaptive Behavior Scales, 2nd edition. Minneapolis, MN: Pearson; 2005.

^h <http://www.sdqinfo.com>.

Source: adapted from Davis AG, Nightingale S, Springer PE, et al. Neurocognitive and functional impairment in adult and paediatric tuberculous meningitis. 2019.



For further information, please contact:

World Health Organization

20, Avenue Appia CH-1211 Geneva 27 Switzerland

Global TB Programme

Web site: www.who.int/tb



**World Health
Organization**

